

Calcium Movements, Distribution, and Functions in Smooth Muscle

HIDEAKI KARAKI^a, HIROSHI OZAKI, MASATOSHI HORI, MINORI MITSUI-SAITO, KEN-ICHI AMANO, KEN-ICHI HARADA, SHIGEKI MIYAMOTO, HIROSHI NAKAZAWA, KYUNG-JONG WON AND KOICHI SATO

Department of Veterinary Pharmacology, Graduate School of Agriculture and Life Sciences, The University of Tokyo, Bunkyo-ku, Tokyo, Japan

I. Introduction	158
II. Calcium movements	159
A. Calcium movements predicted from muscle contraction	159
B. Measurements of radioactive calcium fluxes	159
1. Slowly exchanging calcium fraction	159
2. Lanthanum-inaccessible fraction	160
3. Suggested calcium movements in smooth muscle	161
C. Measurements of cytosolic free calcium level	162
1. Aequorin	162
2. Fluorescent indicators	162
D. Mechanisms of calcium mobilization	164
1. Voltage-dependent calcium channels	164
2. Nonselective cation channel and calcium release-activated calcium channel	165
3. Sodium-calcium exchange	166
4. Calcium release from the sarcoplasmic reticulum	166
5. Calcium pumps in plasmalemma and the sarcoplasmic reticulum	169
6. Mitochondria	170
E. Calcium distribution and function	172
1. Noncontractile Calcium compartment	172
2. Calcium sparks, waves, oscillations, and gradients	175
3. Role of localized calcium	177
III. Changes in calcium sensitivity	178
A. Increase in calcium sensitivity	178
B. Decrease in calcium sensitivity and inhibition of agonist-induced increase	181
IV. Effects of pharmacological agents	181
A. Activators and inhibitors of protein kinases and phosphatases	181
1. Myosin light chain kinase	181
2. A kinase	182
3. G kinase	183
4. C kinase	184
5. Tyrosine kinase	186
6. Phosphatases	188
B. Agents that change sarcoplasmic reticulum function	189
1. Caffeine	189
2. Ryanodine	190
3. Inhibitors of sarcoplasmic reticulum calcium pump	191
C. Stimulants	191
1. Membrane depolarization	191
2. Receptor agonists	192
3. Other constrictors	197
4. Summary	197
D. Relaxants	198
1. Calcium channel blockers	198
2. Potassium channel openers	199

3. Other relaxants	200
4. Summary	205
E. Agents affecting endothelial functions	205
1. Calcium movements in vascular endothelium	205
2. Effects of fluid shear stress	207
3. Relaxant effect of nitric oxide	207
V. Calcium movements, distribution and functions in smooth muscle	208
A. Calcium movements and distribution	208
B. Receptor-effector-structure interrelationship	209
VI. Conclusions	211
VII. Acknowledgments	211
VIII. References	211

I. Introduction

Contraction of smooth muscle is regulated by the cytosolic Ca^{2+} level ($[\text{Ca}^{2+}]_i$)^b, and the sensitivity to Ca^{2+} of the contractile elements in response to changes in the environment surrounding the cell. The first sequence of events in regulation includes the binding of endogenous substances, such as neurotransmitters and hormones, to their specific receptors. This activates various types of guanosine 5'-triphosphate (GTP) binding proteins, which are coupled to different ion channels and enzymes, and modulate their activities. These enzymes include both phospholipase C, which metabolizes phosphatidylinositol and produces inositol 1,4,5-trisphosphate (IP_3) and diacylglycerol, and adenylate cyclase, which metabolizes adenosine 5'-triphosphate (ATP) to produce cyclic adenosine 3',5'-monophosphate (cyclic AMP). Some receptors, such as that for the atrial natriuretic peptide, are directly coupled to guanylate cyclase,

^a Address correspondence to Hideaki Karaki.

^b Abbreviations: $[\text{Ca}^{2+}]_i$, cytosolic Ca^{2+} level; GTP, guanosine 5'-triphosphate; ATP, adenosine 5'-triphosphate; IP_3 , inositol 1,4,5-trisphosphate; cyclic AMP, cyclic adenosine 3',5'-monophosphate; cyclic GMP, cyclic guanosine 3',5'-monophosphate; SR, sarcoplasmic reticulum; MLC, myosin light chain; ADP, adenosine 5'-diphosphate; PSS, physiological salt solution; CRAC, Ca^{2+} release-activated Ca^{2+} channel; CICR, Ca^{2+} -induced Ca^{2+} release; IICR, IP_3 -induced Ca^{2+} release; $\text{GTP}\gamma\text{S}$, guanosine 5'-O-(3-thiotriphosphate); $\text{GDP}\beta\text{S}$, guanosine-5'-O-thiodiphosphate; SHR, spontaneously hypertensive rat; WKY, Wistar Kyoto rat; SERCA, sarcoplasmic reticulum Ca^{2+} -ATPase; STOC, spontaneous transient outward current; MBED, 9-methyl-7-bromoedistomin; RNA, ribonucleic acid; H-7, 1-(5-isoquinolinesulfonyl)-2-methylpiperazine dihydrochloride; ML-9, 1-(5-chloronaphthalene-1-sulfonyl)-1*H*-hexahydro-1,4-diazepine; CGRP, calcitonin gene-related peptide; TPA, 12-O-tetradecanoylphorbol-13-acetate; PDBu, phorbol 12,13-dibutyrate; DPB, 12-deoxyphorbol 13-isobutyrate; DPBA, 12-deoxyphorbol 13-isobutyrate 20-acetate; PDGF, platelet-derived growth factor; SD-3212, semotiadil fumarate (S)-(-)-enantiomer; KB-2796, 1-[bis(4-fluorophenyl)methyl]-4-(2,3,4-trimethoxybenzyl)piperazine dihydrochloride; TMB-8, 8-(*N,N*-diethylamino)octyl-3,4,5-trimethoxybenzoate; KT-362, 5-[3-[(2-(3,4-dimethoxyphenyl)-ethyl)amino]-1-oxopropyl]-2,3,4,5-tetrahydro-15-benzothiazepine fumarate; LP-805, 8-*tert*-butyl-6,7-dihydropyrrolo-[3,2-*e*]-5-methylpyrazolo-[1,5*a*]-pyrimidine-3-carbonitrile; SKF 96365, 1-[3-(4-methoxyphenyl) propoxyl]-1-(4-methoxyphenyl)ethyl-1*H*-imidazole HCl; fura-2/AM, acetoxyethyl ester of fura-2; CGRP, calcitonin gene-related peptide.

which metabolizes GTP to produce cyclic guanosine 3',5'-monophosphate (cyclic GMP).

The second regulatory sequence includes changes in $[\text{Ca}^{2+}]_i$. Calcium influx is the major pathway to increase $[\text{Ca}^{2+}]_i$. This mechanism includes voltage-dependent L-type Ca^{2+} channels, nonselective cation channels, the Ca^{2+} -release activated Ca^{2+} influx pathway, and the reverse mode of the $\text{Na}^+/\text{Ca}^{2+}$ exchanger. Calcium release from the sarcoplasmic reticulum (SR) also increases $[\text{Ca}^{2+}]_i$. A decrease in $[\text{Ca}^{2+}]_i$ is mediated by Ca^{2+} sequestration by the SR, and extrusion by membrane Ca^{2+} pumps and $\text{Na}^+/\text{Ca}^{2+}$ exchanger. Second messengers such as IP_3 , diacylglycerol, cyclic AMP, and cyclic GMP alter $[\text{Ca}^{2+}]_i$ by affecting these mechanisms. Distribution of Ca^{2+} in the cytoplasm is not uniform. Calcium ion in the cytosolic compartments regulates contractile elements, whereas Ca^{2+} in the subplasmalemmal compartments regulates Ca^{2+} -dependent mechanisms in the plasmalemma (ion channels, ion pumps, and enzymes). Calcium concentrations in these compartments are regulated independently.

The third regulatory sequence includes changes in myosin light chain kinase activity. This enzyme is activated by Ca^{2+} and calmodulin and phosphorylates myosin regulatory light chain (MLC). Phosphorylated myosin interacts with actin to induce contraction. Phosphorylated MLC is dephosphorylated by MLC phosphatase. The amount of phosphorylated MLC is therefore dependent on the balance between MLC kinase and MLC phosphatase. However, during continuous stimulation, $[\text{Ca}^{2+}]_i$, the amount of phosphorylated MLC and shortening velocity gradually decrease, whereas isometric force increases monotonically. This indicates that nonphosphorylated myosin is also involved in the maintenance of contraction. Agonists and second messengers modify the MLC kinase/MLC phosphatase ratio independently of $[\text{Ca}^{2+}]_i$. This mechanism, known as Ca^{2+} sensitivity of MLC phosphorylation, changes contractile force even in the presence of a constant level of $[\text{Ca}^{2+}]_i$. Both cyclic AMP and cyclic GMP change the MLC kinase/MLC phosphatase balance and induce relaxation.

All of these mechanisms are supported by energy supplied mainly from oxidative phosphorylation and partly from aerobic glycolysis. Oxidative phosphorylation supplies ATP mainly to contractile elements, whereas aerobic glycolysis supplies ATP mainly to membrane ion pumps. Although smooth muscle develops approximately double the force per cross-sectional area of skeletal muscle, it consumes 100- to 500-fold lower ATP than does skeletal muscle. This difference is explained by the lower ATPase activity of the smooth muscle myosin molecule.

Within the past decade, considerable progress has been made in the understanding of Ca^{2+} movements and distribution in smooth muscle cells. Simultaneous measurements of $[\text{Ca}^{2+}]_i$ and contraction in intact smooth muscle cells and tissues using various types of intracellular Ca^{2+} indicators have allowed analysis of Ca^{2+} sensitivity of contractile elements (see Karaki, 1989a, 1990, 1991). Permeabilization of the cell membrane enabled the measurement of contraction in the presence of the constant concentrations of Ca^{2+} , ATP, and other substances in the cell. Calcium-imaging techniques have revealed uneven distribution of Ca^{2+} in the cell and localized increases in the form of Ca^{2+} sparks and waves. Comparison of the increase in $[\text{Ca}^{2+}]_i$ and contraction suggested the roles of localized Ca^{2+} in regulation of different mechanisms located in different parts inside the cell.

This review article is focused on topics related to mechanisms regulating $[\text{Ca}^{2+}]_i$ and physiological roles of Ca^{2+} in smooth muscle. Effects of pharmacological agents on movements and distribution of Ca^{2+} will also be discussed. Readers should refer to review articles by Abdel-Latif (1986) and Nishizuka (1995) on the receptor-linked signal transduction, by McDonald et al. (1994), Kuriyama et al. (1995) and Knot et al. (1996) on ion channels, by Murphy (1994), Somlyo and Somlyo (1994), and Strauss and Murphy (1996) on regulation of contractile elements, and by Ishida et al. (1994), Paul (1995), and Hellstrand (1996) on energy supply.

II. Calcium Movements

A. Calcium Movements Predicted from Muscle Contraction

Before directly measuring $[\text{Ca}^{2+}]_i$ using the intracellular Ca^{2+} indicators, contraction was considered to be a good indicator of $[\text{Ca}^{2+}]_i$ in smooth muscle, because Ca^{2+} was believed to be the only regulator of contraction. In vascular smooth muscle, two types of stimulants are widely used to identify the changes in $[\text{Ca}^{2+}]_i$: high K^+ -induced membrane depolarization and activation of the α -adrenoceptor by norepinephrine or phenylephrine (Weiss, 1977; Karaki, 1987). Both of these stimuli induced sustained contractions, but with different characteristics. High K^+ -induced sustained contraction was totally abolished by removing external Ca^{2+} and, also,

by agents blocking the Ca^{2+} channels, including cinnarizine (Godfraind and Kaba, 1969), β -diethylaminoethyl diphenylpropyl acetate (SKF525A) (Kalsner et al., 1970), verapamil (Peiper et al., 1971), and La^{3+} (Goodman and Weiss, 1971a, b; Van Breemen et al., 1972). From these results, it was proposed that high K^+ increases transmembrane Ca^{2+} influx, increases $[\text{Ca}^{2+}]_i$ and induces contraction. In contrast, norepinephrine-induced contraction was resistant to removal of external Ca^{2+} . It induced a transient contraction followed by a small sustained contraction in the absence of external Ca^{2+} . Calcium channel blockers and La^{3+} also inhibited the sustained phase more strongly than the transient phase. However, a part of the norepinephrine-induced sustained contraction was not inhibited by La^{3+} or Ca^{2+} channel blockers at the concentrations needed to completely inhibit high K^+ -induced contraction. These results suggest that the norepinephrine-induced transient contraction is due to Ca^{2+} release from intracellular storage site (Hiraoka et al., 1968). The mechanism of the norepinephrine-induced sustained contraction was controversial. It was suggested that this contraction is due mainly to transmembrane Ca^{2+} influx because it is strongly inhibited in the absence of external Ca^{2+} (Somlyo and Somlyo, 1968; Hudgins and Weiss, 1968; Hiraoka et al., 1968; Weiss, 1977). Another possibility was that this contraction is due to Ca^{2+} release from storage sites because both the transient and sustained phases were less sensitive to Ca^{2+} channel blockers than was the high K^+ -induced sustained contraction (Bohr, 1963; Van Breemen et al., 1972). To further examine the mechanisms to increase $[\text{Ca}^{2+}]_i$, it was necessary to directly measure $[\text{Ca}^{2+}]_i$.

B. Measurements of Radioactive Calcium Fluxes

The amount of Ca^{2+} bound outside the cell membrane (approximately 1 mmol/kg of wet tissue) is much greater than the amount of free Ca^{2+} in the cytoplasm (approximately 10 nm to 1 μM) and/or the amount of Ca^{2+} entering the cell during a contractile stimulation (500 pmol of membrane-bound $\text{Ca}^{2+}/\text{cm}^2$ of cell membrane compared to 0.3 pmol of Ca^{2+} influx/ cm^2 of cell membrane) (Bolton, 1979). Since it was not possible to discriminate between Ca^{2+} bound to the membrane surface and Ca^{2+} in the cytoplasm using radioactive $^{45}\text{Ca}^{2+}$, it was difficult to detect changes in transmembrane Ca^{2+} influx in smooth muscle. Thus, various stimulants did not change total $^{45}\text{Ca}^{2+}$ uptake in different types of smooth muscle preparations (see Lullman, 1970; Weiss, 1974, 1977).

1. *Slowly exchanging calcium fraction.* To remove that $^{45}\text{Ca}^{2+}$ present in the extracellular space, Briggs (1962) incubated rabbit aortic strips with solutions containing $^{45}\text{Ca}^{2+}$ for 30–60 min followed by a 10- to 15-min wash-out period with identical non-radioactive solutions. Using this method, it is possible to remove rapidly exchanging Ca^{2+} and measure the slowly exchanging Ca^{2+}

fraction. It was found that high K^+ , epinephrine and norepinephrine increased the amount of $^{45}Ca^{2+}$ remaining after the washout period (Briggs, 1962; Seidel and Bohr, 1971). Ouabain-induced contractions in the rabbit aorta were also shown to be accompanied by an increased $^{45}Ca^{2+}$ uptake (Briggs and Shibata, 1966). This method was also applied to intestinal smooth muscle of the guinea pig taenia coli by Urakawa and Holland (1964), and it was found that various stimulants, including high K^+ , Ba^{2+} , carbachol and histamine, increased $^{45}Ca^{2+}$ uptake (for references see Karaki and Urakawa, 1972). Thus, the amount of Ca^{2+} in the slowly exchanging fraction appears to correlate with contraction. However, the time course of the increase in $^{45}Ca^{2+}$ was slower than that of contraction, and the total amount of $^{45}Ca^{2+}$ increased to as much as $500 \mu\text{mol/kg}$ in 30 min. Furthermore, the decrease in $^{45}Ca^{2+}$ following removal of stimulant was much slower than the decrease in muscle tension (Karaki and Urakawa, 1972). These results suggest that this method measures $^{45}Ca^{2+}$ in a cellular fraction in which Ca^{2+} gradually accumulates during contraction. Since the amount of $^{45}Ca^{2+}$ in this fraction is larger than that in the intracellular space fraction (measured with the lanthanum method as described later), a part of this fraction may exist in the membrane surface. Neither the precise location nor the physiological role of this Ca^{2+} fraction has been defined.

2. *Lanthanum-inaccessible fraction.* Due to their higher charge density, La^{3+} ions were predicted to have greater affinity than Ca^{2+} for any accessible anionic group that binds Ca^{2+} (Lettvin et al., 1964). Based upon anatomical evidence indicating that La^{3+} is restricted to the extracellular compartment (Laszlo et al., 1952), it was found that La^{3+} replaced $^{45}Ca^{2+}$ at superficial membrane sites and prevented $^{45}Ca^{2+}$ uptake to less accessible Ca^{2+} sites in smooth muscle preparations (Weiss and Goodman, 1969; Goodman and Weiss, 1971a, b; Weiss, 1974). Van Breemen et al. (1972) attempted to remove only the extracellular $^{45}Ca^{2+}$ by washing the tissue in a physiological salt solution (PSS) containing 2–10 mM $LaCl_3$ after completion of $^{45}Ca^{2+}$ uptake and before tissue $^{45}Ca^{2+}$ analysis. With this "lanthanum method," they showed that during contraction of rabbit aorta with a high K^+ solution, Ca^{2+} uptake was increased from the resting level of approximately $50 \mu\text{mol/kg}$ of wet tissue to $150 \mu\text{mol/kg}$ of wet tissue. They also found that replacement of Na^+ in PSS by Li^+ increased both $^{45}Ca^{2+}$ uptake and muscle tension. However, there was no change in $^{45}Ca^{2+}$ uptake during contractions induced by $10 \mu\text{M}$ norepinephrine. Norepinephrine increased $^{45}Ca^{2+}$ uptake only when muscle strips were preincubated with Ca^{2+} -free PSS (Deth and Van Breemen, 1974) or in muscles depolarized by high K^+ (Karaki and Weiss, 1979, 1980a, b). These results suggest that $^{45}Ca^{2+}$ uptake increased only under "non-physiological" conditions and appeared to support the ideas that 1) both phases of norepinephrine-induced con-

traction in the rabbit aorta are due mainly to Ca^{2+} release (Van Breemen et al., 1972; Bohr, 1973; Cavero and Spedding, 1983) and 2) access of extracellular Ca^{2+} is essential for refilling the intracellular release site (Deth and Van Breemen, 1977).

To improve the lanthanum method by minimizing loss of $^{45}Ca^{2+}$ during washout with La^{3+} solution, Godfraind (1976) employed a high concentration ($50 \mu\text{M}$) of $LaCl_3$ and found that norepinephrine increased the rate of $^{45}Ca^{2+}$ uptake without changing the total amount of $^{45}Ca^{2+}$ uptake in the rat aorta. Karaki and Weiss (1979) also modified this method for the same purpose by using a combination of high $LaCl_3$ concentration and decreased temperature. They found that norepinephrine increased the total amount of $^{45}Ca^{2+}$ uptake in the rabbit aorta only when it was depolarized. Van Breemen et al. (1981) also used decreased temperature to inhibit the loss of $^{45}Ca^{2+}$. Furthermore, they used EGTA instead of $LaCl_3$ to remove the extracellular $^{45}Ca^{2+}$. With this method, they found that high K^+ and norepinephrine increased the rate of $^{45}Ca^{2+}$ uptake in the rabbit aorta (Meisheri et al., 1981; Van Breemen et al., 1981).

Norepinephrine also transiently increased the rate of $^{45}Ca^{2+}$ efflux (Godfraind, 1976; Deth and Van Breemen, 1977). In addition, norepinephrine decreased that Ca^{2+} concentration at "high affinity Ca^{2+} binding sites" without changing the Ca^{2+} concentration at "low affinity Ca^{2+} sites" (Karaki and Weiss, 1979, 1980a, b, c). These results provide support for the view that norepinephrine releases Ca^{2+} from cellular storage sites.

With the lanthanum method, increases in total $^{45}Ca^{2+}$ uptake could be detected only under nonphysiological conditions such as stimulation with high K^+ . Karaki and Weiss (1981b, 1987) and Karaki et al. (1982) found that inhibition of mitochondrial function with antimycin A, oligomycin, potassium cyanide (KCN) and hypoxia abolished the high K^+ -induced increase in $^{45}Ca^{2+}$ uptake with little effect on contraction. Their finding indicates that the high K^+ -induced increase in $^{45}Ca^{2+}$ uptake is not associated with contraction and represents an incremental uptake of Ca^{2+} into mitochondria rather than as cytosolic free Ca^{2+} . This suggestion is consistent with the fact that the high K^+ -induced increase in $^{45}Ca^{2+}$ uptake (100 to $300 \mu\text{mol/kg}$ wet tissue; Van Breemen et al., 1972; Karaki and Weiss, 1979) is much higher than the amount of Ca^{2+} necessary to induce contraction in permeabilized smooth muscle fibers (0.3 to $3 \mu\text{M}$; Endo et al., 1977). Thus, high K^+ -induced depolarization, increased Ca^{2+} influx, and accumulation of mitochondrial Ca^{2+} constitute a sequential process, and the final step in this sequence can be specifically prevented by mitochondrial inhibitors. Thorens and Haeusler (1979) found that papaverine inhibited $^{45}Ca^{2+}$ uptake at a concentration 10 times lower than that needed to inhibit high K^+ -induced contraction in the rabbit aorta. Since papaverine is a potent inhibitor of mitochondrial function

(Tsuda et al., 1977), this result also provides support for the sequence of events outlined above.

In the presence of high K^+ , large amounts of Ca^{2+} entered the cell and were accumulated in mitochondria. Conversely, norepinephrine alone did not increase Ca^{2+} in mitochondria. However, norepinephrine can also increase Ca^{2+} influx because norepinephrine increased mitochondrial Ca^{2+} uptake in the presence of high K^+ (Karaki and Weiss, 1979, 1981b; Meisheri et al., 1981). This result also suggests that high K^+ may augment mitochondrial Ca^{2+} accumulation. Another alternative possibility is that high K^+ may inhibit membrane Ca^{2+} extrusion to increase $[Ca^{2+}]_i$ to a level high enough to stimulate mitochondrial uptake of Ca^{2+} at sites of low Ca^{2+} affinity. However, this is not likely because inhibition of mitochondrial Ca^{2+} uptake did not change the sustained level of the high K^+ -induced contraction (Karaki et al., 1982). Since Ca^{2+} at $1 \mu M$ induces maximum contractile responses in permeabilized smooth muscle, norepinephrine and high K^+ may increase $[Ca^{2+}]_i$ to this level. Such a small increase may not be detectable by the lanthanum method because the resting level of Ca^{2+} uptake is as much as 50 to 300 $\mu mol/kg$ wet tissue (Van Breemen et al., 1972; Karaki and Weiss, 1979).

The effects of Ca^{2+} channel blockers on $^{45}Ca^{2+}$ uptake in the rabbit aorta are also of interest. The same concentrations of methoxyverapamil inhibited both high K^+ -induced $^{45}Ca^{2+}$ uptake and contraction (Meisheri et al., 1981). Similar results were obtained with nisoldipine (Van Breemen et al., 1985), verapamil (Karaki et al., 1984), and diltiazem (Van Breemen et al., 1981, 1984; Cauvin et al., 1984a, b). These results indicate that the high K^+ -induced contraction results from Ca^{2+} influx through the pathway sensitive to Ca^{2+} channel blockers. In contrast to this, methoxyverapamil at concentrations that almost completely inhibit the high K^+ -induced changes had almost no inhibitory effects on that portion of the $^{45}Ca^{2+}$ uptake and the accompanying contraction obtained with a high concentration of norepinephrine ($10 \mu M$). Higher concentrations of methoxyverapamil inhibited the norepinephrine-stimulated $^{45}Ca^{2+}$ uptake with little inhibitory effect on contraction. Nisoldipine (Van Breemen et al., 1985) and diltiazem (Cauvin et al., 1984b; Van Breemen et al., 1984) had similar selective inhibitory effects on $^{45}Ca^{2+}$ uptake. These results suggest that a portion of the contraction induced by a high concentration ($10 \mu M$) of norepinephrine in rabbit aorta is due to Ca^{2+} influx through a pathway less sensitive to Ca^{2+} channel blockers and that another portion of the contraction is not dependent on the increase in Ca^{2+} influx. Contractions which are not dependent on Ca^{2+} influx have been found to be due to both an activation of nonselective cation channels and an increase in Ca^{2+} sensitivity, as discussed in sections II.D. and III.A.

It should also be noted that norepinephrine has concentration-dependent dual effects on $^{45}Ca^{2+}$ influx.

Compared to $^{45}Ca^{2+}$ uptake and contraction stimulated by high K^+ , the $^{45}Ca^{2+}$ uptake and contraction elicited with higher concentrations of norepinephrine are less sensitive to inhibition by Ca^{2+} channel blockers, and those stimulated by lower concentrations of norepinephrine are more sensitive to Ca^{2+} channel blockers than are those stimulated by high K^+ (Van Breemen et al., 1981, 1984). Furthermore, the $^{45}Ca^{2+}$ influx pathway in resistance vessels stimulated by higher concentrations of norepinephrine is more sensitive to Ca^{2+} channel blockers than is the corresponding pathway in the aorta. Mechanisms of these differences are explained by activation of different Ca^{2+} entry pathways, as is discussed in subsequent sections.

3. *Suggested calcium movements in smooth muscle.* Based on these observations, Bolton (1979) and Van Breemen et al. (1979), independently, suggested that the mechanisms of the increase in $[Ca^{2+}]_i$ in smooth muscle can be explained by two different Ca^{2+} influx pathways: receptor-linked and voltage-dependent Ca^{2+} channels (fig. 1). High K^+ induces membrane depolarization which, in turn, opens the voltage-dependent Ca^{2+} channel. This channel is inhibited by agents blocking Ca^{2+} channels including verapamil, nifedipine and La^{3+} . In contrast, norepinephrine releases Ca^{2+} from storage sites to induce initial transient contractions and subsequently opens the receptor-linked Ca^{2+} channel that is controlled by receptors for contractile agonists. In the

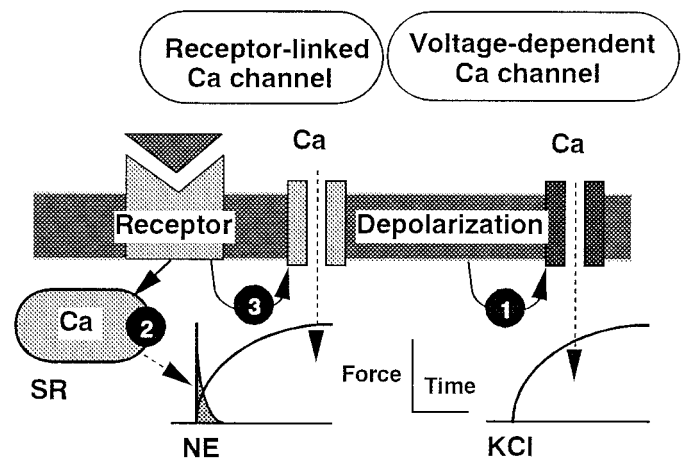

FIG. 1. Calcium movements predicted mainly from contraction. High K^+ depolarizes the membrane, opens the voltage-dependent Ca^{2+} channel, increases Ca^{2+} influx, and elicits sustained contraction (1). Because the voltage-dependent Ca^{2+} channel is inhibited by Ca^{2+} channel blockers, contractions elicited by high K^+ are inhibited by this type of blocker. In contrast, norepinephrine elicits Ca^{2+} release from the SR and initiates contraction (2). Because the amount of Ca^{2+} stored in the SR is limited, contraction due to Ca^{2+} release is transient. Ca^{2+} channel blockers do not inhibit Ca^{2+} release. Norepinephrine also opens the receptor-linked Ca^{2+} channel, increases Ca^{2+} influx, and elicits sustained contraction (3). Calcium channel blockers only weakly inhibit the receptor-linked Ca^{2+} channel. Thus, norepinephrine-induced contraction is less sensitive to Ca^{2+} channel blockers than is high K^+ -induced contraction. This schema can now be revised as shown in figure 7.

aorta, this channel is less sensitive to Ca^{2+} channel blockers than is the voltage-dependent Ca^{2+} channel. Opening of either of these channels results in a continuous Ca^{2+} influx to induce sustained contraction. Existence of two types of Ca^{2+} channels seemed to be indicated by the findings in rabbit aorta that both the rates and total amounts of $^{45}\text{Ca}^{2+}$ uptakes, stimulated by maximally effective concentrations of both high K^+ and norepinephrine, are additive when the two agents were present at the same time (Karaki and Weiss, 1979, 1980a, b; Meisheri et al., 1981). As discussed later, however, it now appears that high K^+ and norepinephrine open the same L-type Ca^{2+} channel and that norepinephrine may also open a receptor-regulated nonselective cation channel which conducts Na^+ , K^+ , and Ca^{2+} . High K^+ and norepinephrine showed an additive effect on $^{45}\text{Ca}^{2+}$ uptake not only because norepinephrine activated both the L-type Ca^{2+} channel and nonselective cation channel but also because high K^+ activated mitochondrial Ca^{2+} uptake. Furthermore, changes in Ca^{2+} sensitivity of contractile elements were not considered at the time.

C. Measurements of Cytosolic Free Calcium Level

1. *Aequorin*. Aequorin is a Ca^{2+} binding protein first extracted from the jelly fish, *Aequorea aequorea*, by Shimomura et al. (1962). This protein emits light at 465 nm in the presence of Ca^{2+} . Ridgway and Ashley (1967) injected this photoprotein into barnacle single muscle fibers and measured $[\text{Ca}^{2+}]_i$ by monitoring changes in aequorin light. This method was applied to a single smooth muscle cell by Fay et al. (1979). Morgan and Morgan (1982, 1984a, b) loaded the 21-kDa photoprotein into smooth muscle cells of ferret portal vein by transiently increasing the membrane permeability using a high concentration of EGTA, and measured $[\text{Ca}^{2+}]_i$ and contraction in isolated smooth muscle strips. They found that high K^+ induced a sustained increase in $[\text{Ca}^{2+}]_i$ during sustained contraction, and both increases were inhibited by a decrease in extracellular Ca^{2+} concentrations (Morgan and Morgan, 1982, 1984a, b; De Feo and Morgan, 1985). This supports the view that the high K^+ -induced contraction is due to an increase in $[\text{Ca}^{2+}]_i$ resulting from activation of Ca^{2+} influx. In contrast, stimulation of the α -adrenoceptors by phenylephrine induced a rapid rise of $[\text{Ca}^{2+}]_i$ to a maximum from which it decreased rapidly to a lower level and then declined more slowly, staying only slightly above basal $[\text{Ca}^{2+}]_i$. At the same time, muscle tension rapidly increased to a maximum level and remained elevated as long as stimulation continued. During the phenylephrine-induced sustained contraction, removal of external Ca^{2+} decreased $[\text{Ca}^{2+}]_i$ to a level lower than basal $[\text{Ca}^{2+}]_i$ and partially inhibited the contraction. From these results, it was postulated that the contractions induced by phenylephrine and high K^+ are due to elevation of $[\text{Ca}^{2+}]_i$ above baseline, and that phenylephrine may increase

the effectiveness of Ca^{2+} on the contractile apparatus (Morgan and Morgan, 1984b). Receptor agonists produced a larger force at a given $[\text{Ca}^{2+}]_i$ than did high K^+ during the period of force maintenance also in ferret aorta (Suematsu et al., 1991b), rabbit aorta (Takuwa and Rasmussen, 1987), guinea pig aorta (Jiang et al., 1994), swine carotid artery (Rembold and Murphy, 1988a; Rembold, 1990) and canine and bovine trachea (Gerthoffer et al., 1989; Takuwa et al., 1987).

Although the agonist-induced sustained phase of the aequorin signal was believed to represent average $[\text{Ca}^{2+}]_i$, interpretation of the initial large transient increase in the aequorin signal was difficult. Measuring the light intensity of the aequorin signal, the peak level of the initial transient phase was 10 to 20 times higher than that of the sustained level (Abe et al., 1995). Aequorin has three Ca^{2+} binding sites in its molecule and occupation of at least two binding sites by Ca^{2+} results in radiation. Thus, the amount of radiation is proportional to 2.5th power of the Ca^{2+} concentration (Blinks et al., 1978). Calculating the Ca^{2+} concentration from light intensity by logarithmic transform, the agonist-induced transient phase of $[\text{Ca}^{2+}]_i$ is still 2.5 to 3.3 times higher than that of the sustained level. This result is different from that obtained with a fluorescent Ca^{2+} indicator, fura-2, which indicated that the peak levels of the agonist-induced transient and the sustained phases were almost identical (Abe et al., 1995). Furthermore, the agonist-induced initial increase in $[\text{Ca}^{2+}]_i$ was much larger than the sustained increase or the increase induced by high K^+ . Even so, the initial transient contraction was much smaller than that expected from the increase in $[\text{Ca}^{2+}]_i$. Another interesting finding is that the initial transient increase in aequorin signal was rapidly desensitized by repeated applications of agonist although contractions did not change (Rembold and Murphy, 1988b; Abe et al., 1995). The most likely explanation for the initial transient aequorin signal is that it represents the local increases in $[\text{Ca}^{2+}]_i$, as discussed later (see section II.E.1.).

2. *Fluorescent indicators*. A new fluorescent Ca^{2+} indicator, quin2, was synthesized by Tsien (1980). This was soon followed by the second generation of indicators including fura-2 and indo-1 (Grynkiewicz et al., 1985). These indicators are not membrane-permeable. To increase permeability, an acetoxymethyl radical is attached to these indicators. After loading smooth muscle cells with the acetoxymethyl esters of these indicators, the acetoxymethyl moiety is cleaved by endogenous esterases and the indicator is trapped in the cell.

Measurements of $[\text{Ca}^{2+}]_i$ by the fluorescent indicators in smooth muscle tissues are much more difficult than in single cells. Abe and Karaki (1989) reported that, when 5 μM acetoxymethyl ester of fura-2 (fura-2/AM) was added to PSS, most of fura-2/AM was precipitated, and only 1 μM was detected in the solution. Using this solution, smooth muscle strips were not loaded with fura-2/

AM, although platelets and single smooth muscle cells took up fura-2/AM. Centrifugation of this solution at $10,000 \times g$ for 2 min decreased the effective concentration of fura-2/AM to approximately 70% and there was no detectable fura-2/AM in the supernatant after a centrifugation at $50,000 \times g$ for 20 min. This result indicates that fura-2/AM is insoluble in PSS, that only a small amount disperses as particles of various sizes, and that most of the particles are so large they are not able to enter the extracellular matrix of the smooth muscle tissues. To solubilize fura-2/AM, it is necessary to add small amounts of detergent and apply strong ultrasonic waves. Using this procedure, smooth muscle tissues can be loaded with fura-2/AM.

Using fura-2 as an indicator, Ozaki et al. (1987c), in vascular tissue, and Himpens et al. (1988), in intestinal tissue, succeeded in obtaining simultaneous measurements of $[Ca^{2+}]_i$ and contraction. They found that $[Ca^{2+}]_i$ measured with fura-2 showed better correlation with contraction than did $[Ca^{2+}]_i$ measured with aequorin. In rat aorta, both high K^+ and norepinephrine induced the sustained increases in $[Ca^{2+}]_i$ during sustained contraction (Ozaki et al., 1987c; Sato et al., 1988a). In guinea pig ileum and taenia coli, high K^+ elicited the sustained increases in $[Ca^{2+}]_i$ and sustained contractions, whereas carbachol elicited the transient increases in $[Ca^{2+}]_i$ and transient contractions (Himpens et al., 1988; Ozaki et al., 1988; Mitsui and Karaki, 1990).

Scanlon et al. (1987) and Malgaroli et al. (1987) reported a method to calculate Ca^{2+} concentrations from fura-2 fluorescence in various types of animal tissues. However, it is difficult to obtain reliable values because of various limitations of fluorescent Ca^{2+} indicators (see Karaki, 1989a). Among these, the most serious problem is that the change in dissociation constant (K_d) of fura-2 for Ca^{2+} . The K_d value measured in vitro is different from that in cytoplasm mainly because fura-2 binds to cytosolic proteins, changes K_d , and changes its fluorescent characteristics (Konishi et al., 1988; Abe and Karaki, 1989; Mitsui and Karaki, 1990; Groden et al., 1991; Hochstrate and Juse, 1991). Furthermore, endogenous fluorescence, the intensity of which is also regulated by $[Ca^{2+}]_i$ (Ozaki et al., 1988), interferes with the fura-2 fluorescence. Furthermore, fura-2 leaks out of the cell relatively rapidly (Mitsui et al., 1993). Despite these difficulties, it was suggested that resting $[Ca^{2+}]_i$ is 100 to 200 nM and that high K^+ and receptor agonists increase $[Ca^{2+}]_i$ to 300 to 1500 nM in vascular (Sato et al., 1988a) and intestinal smooth muscle (Himpens et al., 1988; Ito et al., 1988; Yagi et al., 1988; Mitsui and Karaki, 1990). These results support the suggestion that smooth muscle contractility is primarily regulated by changes in $[Ca^{2+}]_i$.

However, dissociation was observed between $[Ca^{2+}]_i$ and contraction in muscles stimulated with different agonists. In rat aorta, the maximum effective concentra-

tion of norepinephrine induced a smaller increase in $[Ca^{2+}]_i$ than did the maximum effective concentration of KCl even though the norepinephrine-induced contraction was larger than that induced by high K^+ (Sato et al., 1988a; Karaki et al., 1988a), although the dissociation was much smaller than that measured with aequorin. Similar results were obtained with other agonists including endothelin-1 (Sakata et al., 1989; Kodama et al., 1994; Sudjarwo et al., 1995; Karaki and Matsuda, 1996), prostaglandin $F_{2\alpha}$ (Ozaki et al., 1990c; Balwierczak, 1991), serotonin (Thorin-Trescases et al., 1990), carbachol (Ozaki et al., 1990b; Himpens and Casteels, 1990), clonidine (Takayanagi and Onozuka, 1990), thromboxane analog (Himpens et al., 1990), pilocarpine (Takayanagi and Ohtsuki, 1990; Takayanagi et al., 1990), acetylcholine (Sato et al., 1994a) and neurokinin A (Sato et al., 1994b). These results support the view that agonists can increase Ca^{2+} sensitivity of contractile elements (see section III.). In guinea pig ileum (Matthijs et al., 1990; Himpens and Casteels, 1990), in contrast, the Ca^{2+} sensitivity of the contractile elements was decreased during the sustained response to high K^+ , whereas no changes were observed during prolonged stimulation with substance P. Some relaxants showed different types of dissociation. Relaxants which increase cyclic AMP and cyclic GMP relaxed smooth muscle stimulated by high K^+ or receptor agonists with a smaller inhibitory effect on $[Ca^{2+}]_i$, suggesting that both of these cyclic nucleotides decrease Ca^{2+} sensitivity of contractile elements (see sections III. and IV.A.2. and 3.).

Because of various problems related to $[Ca^{2+}]_i$ measurements using intracellular indicators, however, observed dissociation between $[Ca^{2+}]_i$ and contraction may be due to artifacts. These include uneven distribution of indicator in the cell, interference of the Ca^{2+} signal by endogenous fluorescent substances, and heterogeneous cell population in sample cells and tissues. Uneven distribution of Ca^{2+} in the cell may also affect the relationship between contraction and average $[Ca^{2+}]_i$ in the cell. To confirm the changes in Ca^{2+} sensitivity, therefore, it is necessary to measure the $[Ca^{2+}]_i$ -force relationship using a completely different method. Permeabilized smooth muscle preparations are generally used for this purpose (Endo et al., 1977; Pfitzer, 1996) and the effects of agonists and cyclic nucleotides on Ca^{2+} sensitivity are confirmed using this method. In the muscle permeabilized with α -toxin or β -escin, however, Kerrick and Hoar (1994) reported the possibility that the adenosine 5'-diphosphate (ADP)/ATP ratio within the cell is changed and the cells are not freely permeable to Ca^{2+} -ethylenglycoltetraacetic acid. Care must be taken to make sure that the concentrations of intracellular ADP, ATP, and Ca^{2+} are held constant. Differences between the aequorin signal and the fura-2 signal may be due to characteristics of aequorin including: 1) insensitivity at low Ca^{2+} concentrations and resulting difficulty in de-

tection of $[Ca^{2+}]_i$ changes near the resting level, 2) non-linear response that results in an exaggerated effect in producing light if localized high concentrations of Ca^{2+} exist, and 3) possible inhomogeneous distribution of aequorin in the cell (Karaki, 1989a; Somlyo and Himpens, 1989).

D. Mechanisms of Calcium Mobilization

1. Voltage-dependent calcium channels. There are six subtypes of voltage-dependent Ca^{2+} channels: L-, N-, P-, Q-, R-, and T-type. In smooth muscle, only the L-type Ca^{2+} channel is considered to be a major Ca^{2+} influx pathway (Vogalis et al., 1991; Ganitkevich and Isenberg, 1991; Kuriyama et al., 1995; Knot et al., 1996; Hofmann and Klugbauer, 1996). This channel is activated by membrane depolarization and inhibited by Ca^{2+} channel blockers (see Godfraind et al., 1986). Agonists open this channel by depolarizing the cell membrane through activation of the nonselective cation channel (Pacaud and Bolton, 1991), inhibition of the K^+ channel and/or activation of the Cl^- channel (Kremer et al., 1989; Pacaud et al., 1991; Miyoshi and Nakaya, 1991; Iijima et al., 1991). Furthermore, agonists may open the L-type Ca^{2+} channels directly or indirectly through GTP-binding proteins in the absence of membrane depolarization (Nelson et al., 1988; Worley et al., 1991; Welling et al., 1992a, b, 1993; Tomasic et al., 1992; Kamishima et al., 1992).

The L-type Ca^{2+} channel is rapidly desensitized during sustained depolarization. However, high K^+ -induced depolarization induces a sustained increase in $[Ca^{2+}]_i$ and a sustained contraction. Electrophysiological studies showed that depolarization increased Ca^{2+} current, reaching a peak at about 10 ms and then decreasing to a very low level. This small inward current is termed the noninactivating current, which is responsible for the sustained increases in $[Ca^{2+}]_i$ (Imaizumi et al., 1991; Fleischmann et al., 1994; Nakayama et al., 1996).

In rat aorta, a Ca^{2+} channel blocker, verapamil, inhibited both the increase in $[Ca^{2+}]_i$ and the accompanying contraction induced by high K^+ in a concentration-dependent manner. As shown in fig. 2, higher concentrations of verapamil completely inhibited both the increase in $[Ca^{2+}]_i$ and the contraction induced by high K^+ (Sato et al., 1988a; Karaki et al., 1991). Verapamil also inhibited the norepinephrine-induced increase in $[Ca^{2+}]_i$ in a concentration-dependent manner. Similar results were obtained with other Ca^{2+} channel blockers in other types of smooth muscle stimulated with other agonists, suggesting that the effects of verapamil are not due to nonselective inhibitory effects (see section IV.D.1.). These results do not support the idea that agonists open the receptor-linked Ca^{2+} channel, which is resistant to Ca^{2+} channel blockers (fig. 1). Norepinephrine and other agonists seem to open the same verapamil-sensitive, L-type Ca^{2+} channel as does high K^+ , and this channel may be the major Ca^{2+} influx pathway in smooth muscle.

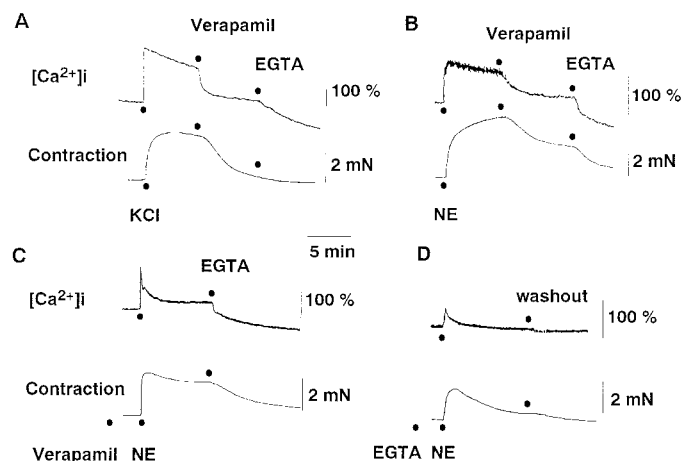

FIG. 2. Changes in $[Ca^{2+}]_i$ and contraction induced by high K^+ and norepinephrine in the rat aorta without endothelium. Changes in $[Ca^{2+}]_i$ and contraction were measured simultaneously in the tissues loaded with a fluorescent Ca^{2+} indicator, fura-2. (A and B): Effects of $72.7 \mu M$ KCl and $1 \mu M$ norepinephrine, respectively. Addition of a stimulant increased both $[Ca^{2+}]_i$ and muscle tension. Addition of $10 mM$ verapamil almost completely inhibited $[Ca^{2+}]_i$ stimulated by high K^+ or norepinephrine. High K^+ -induced contraction was also strongly inhibited (A). However, norepinephrine-induced contraction was only partially inhibited (B). Decrease in external Ca^{2+} by $4 \mu M$ ethyleneglycoltetraacetate (EGTA) decreased $[Ca^{2+}]_i$ below the resting level and further inhibited the norepinephrine-induced contraction. However, a small portion of the contraction was resistant to EGTA (B). (C): Effects of norepinephrine in the presence of verapamil. Ten minutes after the addition of $10 mM$ verapamil, $1 \mu M$ norepinephrine was added, which elicited a transient increase in $[Ca^{2+}]_i$ followed by a small sustained increase. These changes were followed by rapid increase in muscle tension followed by sustained contraction that was smaller than that observed in the absence of verapamil in (B). (D): Effects of norepinephrine in the presence of EGTA. Five minutes after the addition of $4 mM$ EGTA, $1 \mu M$ norepinephrine was added. Norepinephrine elicited only a small transient increase in $[Ca^{2+}]_i$, accompanied by a rapid increase in muscle tension followed by a small sustained contraction that was smaller than that observed in the presence of verapamil in (C). (Modified from Ozaki et al., 1990c and Karaki et al., 1991).

The L-type Ca^{2+} channel activity is regulated also by the SR. Depletion of SR Ca^{2+} by ryanodine in rat femoral artery increased $[Ca^{2+}]_i$ and muscle tone, both of which were inhibited by verapamil (Kojima et al., 1994). In rat aorta (Sekiguchi et al., 1996), inhibition of the SR Ca^{2+} pump by cyclopiazonic acid depolarized the membrane and increased $[Ca^{2+}]_i$. In guinea pig ileum (Uyama et al., 1993), cyclopiazonic acid also increased $[Ca^{2+}]_i$ and muscle tone both of which were inhibited by verapamil. Depletion of SR Ca^{2+} may inhibit the Ca^{2+} -activated K^+ channel, depolarize the membrane and open the L-type Ca^{2+} channel. Agonists that release Ca^{2+} from the SR may have similar effects.

Calcium entry through the L-type Ca^{2+} channel is important to maintain the basal tone of smooth muscle (Rubart et al., 1966), especially in the arteries of spontaneously hypertensive rats (Sada et al., 1990; Sasaki et al., 1993; Asano et al., 1993, 1995b). Stretching vascular tissues activates the L-type Ca^{2+} channels and increases

basal tone in coronary artery and basilar artery (Nakayama and Tanaka, 1989, 1993).

The L-type Ca^{2+} channel is activated by the β -adrenoceptor in the cells isolated from tracheal (Welling et al., 1992a, b), rabbit ear artery (Benham and Tsien, 1988), guinea pig taenia coli (Muraki et al., 1993), rat aorta (Neveu et al., 1994) and rabbit portal vein (Xiong et al., 1994). Although opening of the L-type Ca^{2+} channels increase $[\text{Ca}^{2+}]_i$, at least in a part of the smooth muscle cell, stimulation of the β -adrenoceptors induce relaxation but not contraction. This discrepancy may be explained by the increase in cyclic AMP and also by the presence of a noncontractile Ca^{2+} compartment in the cell (see sections III.B. and IV.A.2.).

2. *Nonselective cation channel and calcium release-activated calcium channel.* Although the larger part of the agonist-induced Ca^{2+} increase was inhibited by Ca^{2+} channel blockers, a part of the increase was not. Verapamil did not completely inhibit the norepinephrine-induced increase in $[\text{Ca}^{2+}]_i$ at concentrations which completely inhibited the high K^+ -induced increase in $[\text{Ca}^{2+}]_i$ (Karaki et al., 1988a). Similar results were obtained with other Ca^{2+} channel blockers in other types of smooth muscles stimulated with other agonists (Sakata et al., 1989; Ozaki et al., 1990c; Sakata and Karaki, 1992; Hori et al., 1992). In the presence of verapamil, norepinephrine elicited a transient increase in $[\text{Ca}^{2+}]_i$ followed by a small sustained increase in the rat aorta (fig. 2). Since the transient increase in $[\text{Ca}^{2+}]_i$ was inhibited by inhibitors of SR function such as ryanodine and thapsigargin, this increase may result from Ca^{2+} release from the SR by a mechanism that is insensitive to verapamil. In contrast, the small sustained increase in $[\text{Ca}^{2+}]_i$, which was insensitive to verapamil, was inhibited by micromolar concentrations of La^{3+} (Harada et al., 1994, 1996). Since the Ca^{2+} channel blockers are believed to selectively inhibit the L-type Ca^{2+} channel (see review by Godfraind et al., 1986; Catterall, 1993; Kuriyama et al., 1995), and since La^{3+} inhibits both the L-type and non-L-type Ca^{2+} channels (Weiss, 1974, 1977, 1996; Ruegg et al., 1989; Hescheler and Schultz, 1993; Krautwurst et al., 1994; but see Inoue and Chen, 1993), these results suggest that the norepinephrine-induced increase in $[\text{Ca}^{2+}]_i$ is due to Ca^{2+} influx through both the L-type and non-L-type Ca^{2+} channels. Enoki et al. (1995a, b) also showed that endothelin-1-induced Ca^{2+} influx, which was insensitive to Ca^{2+} channel blockers, was inhibited by a putative inhibitor of nonselective cation channel, mefenamic acid. Electrophysiological studies have also shown that receptor agonists activate the L-type Ca^{2+} channel and also the nonselective cation channel which is permeable to Ca^{2+} (Nelson et al., 1988; Kuriyama et al., 1995; Knot et al., 1996). In cultured A10 smooth muscle cells, it was suggested that receptors are directly coupled to the non-L-type Ca^{2+} entry pathways (Simpson et al., 1990).

In some vascular smooth muscles, Ca^{2+} influx through the non-L-type Ca^{2+} influx pathway does not seem to induce contraction. In rat aorta, the ATP-induced sustained increase in $[\text{Ca}^{2+}]_i$, which is due to Ca^{2+} influx, was only slightly inhibited by verapamil (Kitajima et al., 1994). Electrophysiological studies showed that ATP opens a nonselective cation channel which permits Ca^{2+} entry; this may be the mechanism of Ca^{2+} influx induced by ATP (Benham and Tsien, 1987; Benham, 1992). In single patch-clamped smooth muscle cells of rat portal vein (Pacaud et al., 1994), ATP-induced Ca^{2+} influx through nonselective cation channels activated the Ca^{2+} -induced Ca^{2+} release from the SR. However, ATP induced much smaller contractions than predicted from the increase in $[\text{Ca}^{2+}]_i$ (Kitajima et al., 1993, 1996a). This dissociation may be explained by the presence of a noncontractile Ca^{2+} compartment in the cell (see section II.E.1.).

Another Ca^{2+} influx pathway which is not inhibited by Ca^{2+} channel blockers is the Ca^{2+} release-activated Ca^{2+} channel (CRAC) or capacitative Ca^{2+} entry pathway (Putney, 1990). In smooth muscle, Casteels and Droogmans (1981) first suggested a possibility that there is a coupling between the peripheral SR and the surface membrane, allowing a one way rapid inward movement of Ca^{2+} . Cauvin et al. (1983, 1984b) reported that lower concentrations of norepinephrine had less ability to release intracellular Ca^{2+} , that norepinephrine did not release intracellular Ca^{2+} in the resistance arteries, and that Ca^{2+} channel blockers inhibited Ca^{2+} influx only in the resistance arteries. Their results suggest that Ca^{2+} release opens a Ca^{2+} influx pathway which is not sensitive to Ca^{2+} channel blockers. In cultured vascular A10 cells, inhibition of the SR Ca^{2+} pump by thapsigargin mobilized an IP_3 -sensitive SR Ca^{2+} pool and activated Ca^{2+} entry through a nicardipine-insensitive pathway (Xuan et al., 1992). In A7r5 cells (Byron and Taylor, 1995), arginine-vasopressin increased $[\text{Ca}^{2+}]_i$ by two different pathways, one of which is activated by depletion of SR Ca^{2+} . In rabbit inferior vena cava, inhibition of SR Ca^{2+} accumulation by caffeine, ryanodine, and thapsigargin increased the steady-state $[\text{Ca}^{2+}]_i$ (Chen and Van Breemen, 1993). In rat aorta, depletion of a Ca^{2+} store by ryanodine and caffeine increased $[\text{Ca}^{2+}]_i$ and muscle tone, both of which were insensitive to nicardipine (Hisayama et al., 1990). In bovine and porcine coronary arteries, ryanodine increased $[\text{Ca}^{2+}]_i$ (Wagner-Mann et al., 1992). In rat ileum (Ohta et al., 1995), the application of Ca^{2+} after exposure to a Ca^{2+} -free solution caused a small contraction and a rise in $[\text{Ca}^{2+}]_i$, both of which were potentiated when the muscle was challenged with carbachol or caffeine before the addition of Ca^{2+} . Inhibition of SR Ca^{2+} pump by cyclopiazonic acid increased the Ca^{2+} -induced responses. Increases in $[\text{Ca}^{2+}]_i$ and contraction were inhibited by Cd^{2+} , Ba^{2+} , Ni^{2+} , or La^{3+} , but not by methoxyverapamil and nifedipine (Ohta et al., 1995). These

results suggest the existence of CRAC in smooth muscle, and that an increase in $[Ca^{2+}]_i$ due to this mechanism is coupled to contraction. In ferret portal vein (Abe et al., 1996) and urinary bladder, however, the increases in $[Ca^{2+}]_i$ due to CRAC does not seem to induce contractions (see section II.E.1.).

3. *Sodium-calcium exchange*. Bohr (1964) and Reuter et al. (1973) originally reported the contraction in rabbit aorta under conditions which implicate a Na^+/Ca^{2+} exchange mechanism (Na^+ pump inhibition or Na^+ -free solution), although some of these effects were found to be evoked by the release of endogenous catecholamines possibly due to Ca^{2+} influx into adrenergic nerves (Karakaki and Urakawa, 1977; Bonaccorsi et al., 1977; Karaki et al., 1978; Rembold et al., 1992). Experiments using a membrane-enriched microsomal fraction and smooth muscle cells revealed the presence of Na^+ -dependent Ca^{2+} influx and efflux in smooth muscle of swine stomach (Raeymaekers et al., 1985), bovine trachea, porcine aorta and bovine aorta (Slaughter et al., 1987, 1989) and rat aorta (Nabel et al., 1988). Lowering external Na^+ concentration or increasing $[Na^+]_i$ elevated $[Ca^{2+}]_i$ in guinea pig taenia coli (Pritchard and Ashley, 1986, 1987), rat aorta (Matlib et al., 1986), swine carotid artery (Rembold et al., 1992), human mesangial cells (Mene et al., 1990), cultured vascular smooth muscle (Batlle et al., 1991), the A10 cells (Gillespie et al., 1992a), and the A7r5 cells (Vigne et al., 1988; Bova et al., 1990; Gillespie et al., 1992b; Borin et al., 1994). The molecular structure of the Na^+/Ca^{2+} exchanger was also clarified (Nicoll and Philipson, 1991).

Calcium influx mediated by Na^+/Ca^{2+} exchange induces contraction in some types of smooth muscle. In guinea pig aorta, ouabain and K^+ -free solution induced sustained contraction with an increase in $^{45}Ca^{2+}$ influx (Ozaki et al., 1978; Ozaki and Urakawa, 1979, 1981a) and an increase in $[Ca^{2+}]_i$ measured with fura-2 (Iwamoto et al., 1992). In this preparation, Na^+ -free solution alone induced sustained contraction, which was enhanced after loading with Na^+ by pretreatment with ouabain (Ozaki and Urakawa, 1981b). Slodzinski et al. (1995) reported that inhibition of Na^+/Ca^{2+} exchange by antisense in cultured arterial myocytes increased resting $[Ca^{2+}]_i$ and inhibited the ouabain-induced augmentation of the agonist-induced increase in $[Ca^{2+}]_i$. In rabbit aorta, Khoyi et al. (1991) found that the $^{45}Ca^{2+}$ uptake increased in the absence of external Na^+ .

Na^+/Ca^{2+} exchange may be important for Ca^{2+} extrusion because, in the membrane fraction of bovine aortic smooth muscle, the Na^+/Ca^{2+} exchanger has 3–6-fold transporting capacity than that of sarcolemmal Ca^{2+} -ATPase (Slaughter et al., 1989). Furthermore, co-localization of the Na^+/Ca^{2+} exchanger, Na^+ - K^+ pump, and a marker of the SR, calsequestrin, has been defined by high resolution, three dimensional microscope (Moore et al., 1993), suggesting a linkage between Na^+/Ca^{2+} exchange and Ca^{2+} release from the SR. In A7r5 cells,

ouabain increased both $[Na^+]_i$ and $[Ca^{2+}]_i$, and greatly augmented the release of Ca^{2+} from the SR evoked by thapsigargin, vasopressin and serotonin (Borin et al., 1994). Ouabain increased membrane-bound Ca^{2+} measured with chlortetracycline, and this increase was inhibited by thapsigargin or caffeine. These results support the existence of functional linkage between Na^+/Ca^{2+} exchange and the SR. Ouabain may increase SR Ca^{2+} by increasing $[Na^+]_i$ and indirectly increasing $[Ca^{2+}]_i$ via Na^+/Ca^{2+} exchange across the sarcolemma. Most of Ca^{2+} that enters the cytoplasm is then stored in the SR, and this extra Ca^{2+} in SR can be mobilized so that the subsequent vasoconstrictor-evoked transient increases in $[Ca^{2+}]_i$ are amplified.

In contrast to the above results, others reported that Na^+/Ca^{2+} exchange plays little role in cellular Ca^{2+} homeostasis (Droogmans and Casteels, 1979; Aaronson and Van Breemen, 1981; Mulvany et al., 1984). Na^+ -depletion alone did not increase muscle tone in rat aorta and mesenteric artery, whereas contractions induced by high K^+ , serotonin and arginine-vasopressin were augmented by low Na^+ solution (Bova et al., 1990). Also, in guinea pig coronary myocytes, removal of extracellular Na^+ induced large increases in $[Ca^{2+}]_i$ only in Na^+ -loaded cells, although either Na^+ removal alone or Na^+ loading alone did not change $[Ca^{2+}]_i$ (Ganitkevich and Isenberg, 1993a). These results support the suggestion that Na^+/Ca^{2+} exchange is of minor importance for the increase in $[Ca^{2+}]_i$ as long as $[Na^+]_i$ is kept at physiological level. Aaronson and Benham (1989) reported that, in guinea pig urethra, although Na^+/Ca^{2+} exchange can modulate $[Ca^{2+}]_i$ when $[Na^+]_i$ and membrane potential are at or near their physiological levels, $[Ca^{2+}]_i$ is regulated mainly by a Na^+ -independent Ca^{2+} extrusion system. Morel and Godfraind (1984) showed that Na^+/Ca^{2+} exchange had a lower capacity, a lower affinity, and a slower rate than the ATP-dependent Ca^{2+} pump in plasmalemmal vesicles isolated from guinea pig ileum and aorta. In equine airway myocytes, the time constant for the decay in $[Ca^{2+}]_i$ after the stimulation of Ca^{2+} influx by depolarization pulse was not decreased in the absence of external Na^+ (Fleischmann et al., 1996). Similar results were obtained in guinea pig coronary myocytes (Ganitkevich and Isenberg, 1993a).

The inconsistent results for the physiological significance of Na^+/Ca^{2+} exchange may be due to differences between different species and different tissues (Ozaki and Urakawa, 1981a; Petersen and Mulvany, 1984).

4. *Calcium release from the sarcoplasmic reticulum*. Measuring $[Ca^{2+}]_i$ in the SR in saponin-permeabilized cultured A7r5 aortic smooth muscle cells using a fluorescent Ca^{2+} indicator, furaptra, Sugiyama and Goldman (1995) found that the K_d of the SR for Ca^{2+} was 49 μM and resting SR Ca^{2+} was 75–130 μM . In smooth muscle, Ca^{2+} is released from the SR (Stout and Diecke, 1983; Yamamoto and Van Breemen, 1986; Iino, 1987; Sato et al., 1988a). There are two types of mechanisms to

release Ca^{2+} from the SR in smooth muscle, Ca^{2+} -induced Ca^{2+} release (CICR) (Endo, 1977; Ogawa, 1994; Zucchi and Ronca-Testoni, 1994) and IP_3 -induced Ca^{2+} release (IICR) (Ferris and Snyder, 1992; Mikoshiba, 1993; Putney and Bird, 1993). CICR is activated by Ca^{2+} (Itoh et al., 1981; Saida, 1982; Iino, 1989), whereas IICR is activated by IP_3 (Suematsu et al., 1984; Somlyo et al., 1985; Islam et al., 1996). IICR is regulated not only by IP_3 but also by Ca^{2+} . IICR is enhanced by Ca^{2+} below 300 nM and, above this concentration, Ca^{2+} inhibited IICR (Iino, 1990; Iino and Endo, 1992; Iino and Tsukioka, 1994). Calcium influx through the L-type Ca^{2+} channels also activates CICR in guinea pig aorta and urinary bladder and rat portal vein and mesenteric artery (Ito et al., 1991a; Ganitkevich and Isenberg, 1992; Gregoire et al., 1993). Calcium influx mediated by the reverse-mode action of the $\text{Na}^+/\text{Ca}^{2+}$ exchanger, which was undetectable by fura-2, released Ca^{2+} from the thapsigargin-sensitive intracellular stores including IP_3 -releasable pools in cultured guinea pig ileum longitudinal muscle cells (Ohata et al., 1996). CICR is selectively activated by caffeine and selectively inhibited by ryanodine (Ito et al., 1986; Hisayama and Takayanagi, 1988), whereas IICR is inhibited by heparin (Kobayashi et al., 1988; Ghosh et al., 1988; Chopra et al., 1989; Ganitkevich and Isenberg, 1990; Komori and Bolton, 1990).

In membrane fractions of guinea pig intestinal longitudinal smooth muscle, total binding sites of IP_3 were 9–10-fold more numerous than those of ryanodine (Wibo and Godfraind, 1994). The IP_3 receptor and the ryanodine receptor were localized primarily in the SR. However, the stoichiometric ratio of the IP_3 receptor to the ryanodine receptor was distinctly higher in the high density, ribonucleic acid (RNA)-rich subfractions than in the low density, RNA-poor subfractions, suggesting that the IP_3 receptors were somewhat concentrated in the ribosome-coated portions of the SR. The low overall stoichiometric ratio of the ryanodine to the IP_3 receptors might explain the existence of a Ca^{2+} -storage compartment that is devoid of CICR but has IICR.

Iino and co-workers (Iino et al., 1988; Yamazawa et al., 1992) classified Ca^{2+} stores into two subtypes using the permeabilized fibers of the guinea pig portal vein, pulmonary artery and taenia coli. One of these stores has both CICR and IICR (S_α), whereas the other has only the IICR mechanism (S_β). Ryanodine activated and then locked the CICR channels at open state, but had practically no effect on the IICR mechanism. Thus, after ryanodine-treatment, the Ca^{2+} store with the CICR (S_α) lost its capacity to hold Ca^{2+} . Changes in the agonist-evoked contraction of intact muscle due to the ryanodine treatment suggested that agonists release Ca^{2+} from the S_α store, which produces the initial phase of contractions. In guinea pig taenia coli, CICR channels are present in 40% of the Ca^{2+} stores (Iino, 1990).

In the β -escin-permeabilized longitudinal smooth muscle of guinea pig ileum, caffeine, carbachol or IP_3 produced a transient rise in tension in a Ca^{2+} -free solution (Komori et al., 1995). The effect of either caffeine or carbachol was markedly reduced or abolished after preceding application of the other stimulant. IP_3 was without effect when applied subsequently to caffeine. The effects of carbachol and IP_3 were abolished after combined treatment with ryanodine and caffeine, which causes functional removal of caffeine-releasable Ca^{2+} stores, but not after combined treatment with ryanodine and carbachol. These results suggest that caffeine, carbachol and IP_3 all act on common Ca^{2+} stores to release Ca^{2+} , possibly because this tissue has only the S_α store (with both IICR and CICR). Also, in guinea pig pulmonary artery (Iino, 1990) and rat portal vein (Pacaud and Loirand, 1995), most of the activator Ca^{2+} originates from the S_α store.

Cultured vascular smooth muscle appears to be devoid of ryanodine sensitive Ca^{2+} pools (Missiaen et al., 1990). In A7r5 cells, vasopressin increased the fractional loss of $^{45}\text{Ca}^{2+}$ in Ca^{2+} -free solution which was not influenced by ryanodine. Caffeine did not stimulate the fractional loss of $^{45}\text{Ca}^{2+}$ in this cell line. In saponin-skinned cells, IP_3 released the $^{45}\text{Ca}^{2+}$ which was not affected by ryanodine or caffeine. These results suggest that A7r5 cells have only S_β store (with only IICR).

In single myometrial cells from pregnant rats (Arnau-deau et al., 1994), oxytocin and acetylcholine evoked an initial peak in $[\text{Ca}^{2+}]_i$ followed by a smaller sustained rise. The transient increase in $[\text{Ca}^{2+}]_i$ was abolished by heparin, an inhibitor of IICR (Supattapone et al., 1988), and thapsigargin. In contrast, the transient $[\text{Ca}^{2+}]_i$ response induced by oxytocin was unaffected by ryanodine. Moreover, caffeine failed to increase $[\text{Ca}^{2+}]_i$ but reduced the oxytocin-induced transient $[\text{Ca}^{2+}]_i$ response. In permeabilized fibers of pregnant rat myometrium, caffeine did not produce contraction whereas both IP_3 and the ionophore, A23187, evoked contractile responses (Savineau, 1988). These data show that myometrial cells possess an IP_3 -sensitive and thapsigargin-sensitive store (S_β), but do not possess ryanodine- and caffeine-sensitive stores (S_α).

In contrast to these observations, others suggested that Ca^{2+} stores cannot be classified into only two types. In rat vascular smooth muscle cells (Shin et al., 1991), some cells responded only to caffeine whereas other cells responded only to angiotensin II and released Ca^{2+} from the SR. In rat mesenteric artery smooth muscle cells (Baro and Eisner, 1995), norepinephrine and caffeine produced a transient increase in $[\text{Ca}^{2+}]_i$ in Ca^{2+} free solution. In the presence of norepinephrine, caffeine or thapsigargin elevated $[\text{Ca}^{2+}]_i$. However, if thapsigargin or caffeine was added first, the subsequent application of norepinephrine did not increase $[\text{Ca}^{2+}]_i$. These results may suggest the existence of two types of Ca^{2+} stores; some stores are sensitive to both caffeine and agonist

(S α) whereas other stores are sensitive to caffeine and thapsigargin but not to agonist (S γ with only CICR).

In permeabilized rabbit trachea smooth muscle cells (Chopra et al., 1991), Ca²⁺ release by IP₃ was much greater than with guanosine 5'-O-(3-thiotriphosphate) (GTP γ S). Pretreatment with maximally effective IP₃ abolished the GTP γ S-induced Ca²⁺ release, whereas pretreatment with GTP γ S reduced the IP₃-induced Ca²⁺ release by 25%. Ryanodine gave a large release of SR Ca²⁺. After treatment with ryanodine, GTP γ S did not induce Ca²⁺ release, whereas the IP₃-induced Ca²⁺ release was reduced by 76%. Pretreatment with ryanodine abolished the caffeine-induced Ca²⁺ release, and addition of caffeine before ryanodine reduced the ryanodine-induced Ca²⁺ release by 64%. These results suggest that there are at least three Ca²⁺ pools present within airway smooth muscle cells. The largest pool is released by IP₃ or ryanodine (S α), another is released only by IP₃ (S β), and the third by a high concentration of IP₃, ryanodine or GTP γ S (which may be different from any of the above classifications).

Evidence also suggests a communication between different types of Ca²⁺ stores. In cultured arterial myocytes, Tribe et al. (1994) found that IP₃ and caffeine increased [Ca²⁺]_i by depleting different Ca²⁺ stores in the absence of external Ca²⁺. Moreover, Ca²⁺ could be transferred between two stores, since prior application of caffeine, which alone evoked little or no increase in [Ca²⁺]_i, significantly augmented the response to thapsigargin, which blocks Ca²⁺ sequestration in the IP₃-sensitive store. Conversely, a substantial caffeine-induced rise in [Ca²⁺]_i was observed only after the ability of the thapsigargin-sensitive Ca²⁺ store to sequester Ca²⁺ was inhibited. This suggests that the caffeine-sensitive store has a thapsigargin-insensitive Ca²⁺ sequestration mechanism. Chopra et al. (1991) also reported that, in permeabilized cultured rabbit trachea cells, Ca²⁺ moved from the GTP γ S-sensitive pool into the S α store when this was depleted. Somlyo and co-workers have shown that norepinephrine released Ca²⁺ from both the junctional SR (Bond et al., 1984) and the central SR (Kowarski et al., 1985), and that the lumen of the various regions of the SR is continuous (Devine et al., 1972; Somlyo, 1980) and permits the diffusion of Ca²⁺ from center to periphery or vice versa (Somlyo and Himpens, 1989). Employing digital imaging technique, Tribe et al. (1994) and Golovina and Blaustein (1997) directly visualized the Ca²⁺ stores and found that although the SR appeared to be a continuous tubular network, Ca²⁺ stores in the SR were organized into small, spatially distinct compartments that functioned as discrete units and cyclopiazonic acid and caffeine with ryanodine unloaded different spatially separated compartments.

Characteristics of the SR seem to change during hypertension and other physiological and pathophysiological conditions. In vascular smooth muscle cells from spontaneously hypertensive rats (SHR) and Wistar

Kyoto rats (WKY) (Neusser et al., 1994), thapsigargin induced a transient increase in [Ca²⁺]_i in Ca²⁺ free solution. The thapsigargin-induced peak [Ca²⁺]_i was not different in SHR cells and WKY cells. After depletion of the thapsigargin-sensitive Ca²⁺ pools, angiotensin II still increased [Ca²⁺]_i. In the SHR cells, the angiotensin II-induced increase in [Ca²⁺]_i was not significantly different in the presence and absence of thapsigargin. In contrast, in the WKY cells, the response to angiotensin II was significantly diminished after depletion of the thapsigargin-sensitive pool. Furthermore, when angiotensin II was added before thapsigargin, the thapsigargin response was diminished in the WKY cells but not in the SHR cells. These results suggest that vascular smooth muscle cells of WKY have two types of Ca²⁺ pools, a thapsigargin- and angiotensin II-sensitive type and an angiotensin II-sensitive type, whereas the SHR cells have a thapsigargin-sensitive type and an angiotensin II-sensitive type. Levin et al. (1994) showed that partial outlet obstruction of the rabbit urinary bladder resulted in smooth muscle hypertrophy accompanied by a significant increase in the ability of ryanodine to inhibit contraction induced by field stimulation. Ryanodine binding also increased 4-fold at 5–7 days postobstruction. Thus, smooth muscle hypertrophy secondary to partial outlet obstruction induced a marked increase in the role of intracellular Ca²⁺ in the mediation of the contractile response to field stimulation.

The function of the SR appears to change also with age. Neonatal rabbit bladder smooth muscle is not very sensitive to ryanodine, while that from mature rabbits is extremely sensitive. Gong et al. (1994) demonstrated that the number of ryanodine binding sites increased in rabbit bladder with normal maturation, suggesting that the bladder smooth muscle cell acquires an increased pool of sequestered intracellular Ca²⁺ for the development of normal contraction.

The SR is filled with Ca²⁺ mainly by Ca²⁺ influx. In resting rabbit aorta (Karaki et al., 1979), 25 to 30 min was necessary to fill a norepinephrine-releasable store with Ca²⁺. Almost all of the SR Ca²⁺ was released by single application of 1 μ M norepinephrine, as estimated by the norepinephrine-induced contraction in the absence of external Ca²⁺. Inhibition of Ca²⁺ influx by La³⁺, Mn²⁺, or Cd²⁺ inhibited the filling, whereas verapamil, at the concentrations needed to completely inhibit high K⁺-induced contraction, did not inhibit the filling. This result suggests that resting Ca²⁺ influx, which is not mediated by the L-type Ca²⁺ channel, is responsible for SR Ca²⁺ filling. Since La³⁺ did not change the resting tone of the aorta, resting Ca²⁺ influx does not seem to be coupled to contraction. Calcium ion entering the cell through the resting Ca²⁺ influx pathway may be trapped by the SR without activating contractile elements (Casteels and Droogmans, 1981). In A7r5 cells, Blatter (1995) also showed that after releasing Ca²⁺ from the SR with vasopressin, the filling path-

way of depleted stores involved Ca^{2+} entry into the bulk cytoplasmic compartment before uptake into the store. In the presence of high K^+ , the SR accumulated greater amounts of Ca^{2+} and this process was inhibited by verapamil (Karaki et al., 1979), suggesting that Ca^{2+} entering through the L-type Ca^{2+} channel is also taken up by the SR. In the presence of norepinephrine, however, accumulation of Ca^{2+} by the SR was inhibited in spite of an increase in Ca^{2+} influx. This inhibition may be due to opening of SR Ca^{2+} channel by norepinephrine. Bond et al. (1984) showed that repeated short-term applications of norepinephrine induced contractions in the absence of external Ca^{2+} and in the presence of La^{3+} in the high K^+ -depolarized guinea pig portal vein, suggesting the recycling of SR Ca^{2+} when Ca^{2+} efflux was reduced by La^{3+} .

It is now generally accepted that Ca^{2+} release from the SR is responsible for only an initial portion of the agonist-induced sustained contraction (Karaki and Weiss, 1984, 1988) because, 1) norepinephrine and other agonists induce only a transient contraction in the absence of external Ca^{2+} , 2) agonist-induced IP_3 production is transient (Abdel-Latif, 1986; Marmy et al., 1993; Dorn and Becker, 1993), 3) inhibitors of SR function by ryanodine inhibited the initial portion but not the sustained portion of agonist-induced contractions (Iino et al., 1988; Kanmura et al., 1988; Julou-Schaeffer and Freslon, 1988), and 4) the agonist-induced increase in $[\text{Ca}^{2+}]_i$ was strongly inhibited by Ca^{2+} channel blockers (Sato et al., 1988b; Karaki et al., 1991) although these blockers did not inhibit Ca^{2+} filling of the SR (Karaki et al., 1979; Casteels and Droogmans, 1981). However, Ashida et al. (1988) reported that ryanodine inhibited the norepinephrine-induced contraction by 52% in rat aorta and 14% in bovine tail artery without changing high K^+ -induced contractions. Calcium channel blocker almost completely abolished high K^+ -induced contractions and reduced norepinephrine-induced contractions by 45% in the aorta and 82% in the tail artery. The inhibitory effects of ryanodine and Ca^{2+} channel blocker on the norepinephrine-induced contraction were additive. Using electron-microscopy, they also found that the tail artery has about 60% less SR than does the aorta and suggested that norepinephrine-induced sustained contraction is due to both Ca^{2+} influx through the L-type Ca^{2+} channel and Ca^{2+} release from the SR through the ryanodine-sensitive pathway; and that contractions in rat aorta are more dependent on Ca^{2+} release than in bovine tail artery. Weber et al. (1995) also reported that sustained contractions induced by submaximum concentrations of norepinephrine were significantly inhibited by ryanodine whereas sustained contractions induced by a maximum concentration of norepinephrine were inhibited by a combination of Ca^{2+} channel blocker and ryanodine. Furthermore, Iino et al. (1994a) reported that $[\text{Ca}^{2+}]_i$ oscillations induced by nerve stimulation or submaximum concentrations of norepinephrine were inhibited

by ryanodine in rat tail artery. These results suggest that, in some types of vascular smooth muscle, sustained contractions induced by submaximum concentrations of norepinephrine are due to summation of contractions in individual cells which induce oscillatory contractions by release of SR Ca^{2+} . Graded contractions may result from differences in the threshold in individual cells (Ohta et al., 1994; Suzuki et al., 1994). Since agonist-induced production of IP_3 is transient, the oscillatory release of Ca^{2+} may be due to activation of CICR. In contrast, a maximum concentration of norepinephrine may induce Ca^{2+} influx to evoke sustained contractions in all of the cells. Calcium ion and/or other diffusible messengers can diffuse between smooth muscle cells through gap junctions and propagate Ca^{2+} waves through silent cells (Christ et al., 1992; Young et al., 1996). This mechanism may also contribute to synchronize smooth muscle cells in the absence of synchronization of action potentials or sustained membrane depolarization.

5. Calcium pumps in plasmalemma and the sarcoplasmic reticulum. In smooth muscle, there are two types of Ca^{2+} ATPase, plasmalemmal Ca^{2+} ATPase and SR Ca^{2+} ATPase (Wuytack et al., 1982; Raeymaekers et al., 1985; Verbist et al., 1985; Raeymaekers and Wuytack, 1996). The plasmalemmal Ca^{2+} -ATPase activity was four times higher than the $(\text{Na}^+ + \text{K}^+)\text{-ATPase}$ activity in human myometrial smooth muscle (Popescu and Ignat, 1983). Since Ca^{2+} extrusion through the $\text{Na}^+/\text{Ca}^{2+}$ exchange mechanism would ultimately be limited by the $(\text{Na}^+ + \text{K}^+)\text{-ATPase}$ activity, this result suggests that plasmalemmal Ca^{2+} -ATPase plays a more important role in Ca^{2+} extrusion than does $\text{Na}^+/\text{Ca}^{2+}$ exchange. In cultured rat aortic smooth muscle cells, 12-*O*-tetradecanoylphorbol-13-acetate (TPA) increased the maximum Ca^{2+} efflux rate without changing the affinity for Ca^{2+} (Furukawa et al., 1988, 1989). In Ca^{2+} -ATPase purified from bovine aortic smooth muscle, it was also shown that phorbol ester stimulated the ATPase activity which was accompanied by phosphorylation of the ATPase, suggesting that the plasmalemmal Ca^{2+} -pump in vascular smooth muscle is activated by protein kinase C (C kinase). Sodium nitroprusside and 8-bromo-cyclic GMP also stimulated the Ca^{2+} pump activity although forskolin and dibutyryl cyclic AMP were ineffective (Yoshida et al., 1991; Furukawa et al., 1988).

The SR Ca^{2+} -ATPase (SERCA) is derived from three distinct genes (Eggermont et al., 1989; Lytton et al., 1989; Amrani et al., 1995a); *SERCA-1*, which is expressed in skeletal muscle, *SERCA-2*, which gives rise to the *SERCA-2a* and *SERCA-2b* isoforms, mainly expressed in cardiac and smooth muscles, respectively, and *SERCA-3* expressed in smooth and non-muscle tissue. In human tracheal smooth muscle cells, expression of *SERCA-2b* isoform was greater than that of *SERCA-2a* isoform (Amrani et al., 1995a). The *SERCA-2a*, *SERCA-2b*, and *SERCA-3* are inhibited by thapsi-

gargin (Lytton et al., 1992). Cyclopiazonic acid also inhibits SERCA (Seidler et al., 1989; Bourreau et al., 1991; Low et al., 1992; Uyama et al., 1992, 1993).

Luo et al. (1993) demonstrated that relaxation of arterial smooth muscle induced by nitroglycerin or atrial natriuretic peptide was inhibited by thapsigargin or cyclopiazonic acid without affecting the increment of cyclic GMP content, suggesting that the enhanced sequestration of Ca^{2+} by the SR may be an important mechanism by which nitric oxide-related compounds induce relaxation. In canine trachea (McGrogan et al., 1995), relaxant effects of sodium nitroprusside and 8-bromo-cyclic GMP were attenuated by cyclopiazonic acid. These results are consistent with the finding that G kinase stimulates the plasmalemmal Ca^{2+} pump ATPase (Imai et al., 1990; Yoshida et al., 1991). In small mesenteric resistance arteries of the rat, 3-morpholino-sydnonimine and sodium nitroprusside increased cyclic GMP and inhibited the increase in $[\text{Ca}^{2+}]_i$, MLC phosphorylation and the contractile response to ATP (Andriantsitohaina et al., 1995). Thapsigargin reversed the inhibitory effect of the vasodilator agents when the contraction induced by ATP was elicited in the presence of the Ca^{2+} channel blocker, nitrendipine, or in Ca^{2+} -free medium. These results show that cyclic GMP inhibits ATP-induced contraction partly by enhanced Ca^{2+} sequestration through a SR Ca^{2+} pump activation. In rat aorta, ryanodine, on the other hand, had no effect on the concentration-response curves for isoproterenol-induced relaxation (Hisayama et al., 1990). In rat thoracic aorta and bovine tail artery, Ashida et al. (1988) also showed that, although ryanodine had no effect on basal tone, it progressively increased tension when Ca^{2+} extrusion via $\text{Na}^+/\text{Ca}^{2+}$ exchange was inhibited by low external Na^+ . The smaller effects of ryanodine indicate that the SR plays a less important role in controlling $[\text{Ca}^{2+}]_i$.

In canine tracheal smooth muscle (Bourreau et al., 1993), cyclopiazonic acid inhibited refilling of the stores occurring during high K^+ stimulation. On the other hand, cyclopiazonic acid was less effective in inhibiting the refilling occurring during prolonged acetylcholine stimulation. At higher external Ca^{2+} or when BAY k8644 was present in the medium, cyclopiazonic acid was ineffective in inhibiting the refilling during stimulation with acetylcholine. These results suggest the presence of two different pathways for external Ca^{2+} used to refill acetylcholine-sensitive internal stores. One involves active Ca^{2+} uptake via a cyclopiazonic acid-sensitive Ca^{2+} pump, and the other involves a cyclopiazonic acid-insensitive pathway.

In bovine tail artery cells (Goldman et al., 1989), $[\text{Ca}^{2+}]_i$ was relatively uniformly distributed before activation. During norepinephrine-evoked contractions, $[\text{Ca}^{2+}]_i$ increased, and the distribution of $[\text{Ca}^{2+}]_i$ became much more heterogeneous. On recovery from activation, discrete regions of elevated $[\text{Ca}^{2+}]_i$ were observed throughout the recovered cells. The large spatial varia-

tion of $[\text{Ca}^{2+}]_i$ after cell activation implies that Ca^{2+} was sequestered at localized sites in the cell during relaxation. In rat mesenteric artery cells (Baro and Eisner, 1995), both norepinephrine and caffeine released Ca^{2+} . The recovery of $[\text{Ca}^{2+}]_i$ during the application of caffeine was unaffected by the removal of external Na^+ , suggesting that $\text{Na}^+/\text{Ca}^{2+}$ exchange is not important in the reduction in $[\text{Ca}^{2+}]_i$. The addition of an inhibitor of Ca^{2+} -ATPase, La^{3+} , did, however, greatly slow $[\text{Ca}^{2+}]_i$ recovery. From these and other results, they concluded that the three major factors responsible for removing Ca^{2+} ions from the cytoplasm are: a caffeine- and norepinephrine-sensitive store (43%), a caffeine-sensitive but norepinephrine-insensitive store (36%), and a sarcolemmal Ca^{2+} -ATPase (16%). Finally, a 5% contribution remains to be accounted for.

6. Mitochondria. Mitochondrial inhibitors decrease ATP production and contraction in intestinal smooth muscle. However, neither ATP contents nor contractions were decreased by these inhibitors in vascular smooth muscle, possibly because ATP is supplied not only by mitochondria but also by glycolysis (Karaki et al., 1982; Nakagawa et al., 1985). Inhibition of oxidative phosphorylation by nitrogen gas, dinitrophenol or sodium azide elicited a release of Ca^{2+} from mitochondria to induce transient contraction in rat aorta (Karaki et al., 1982), rabbit colon (Kowarski et al., 1985) and rat myometrium (Sakai et al., 1986). These results suggest the possible involvement of mitochondrial Ca^{2+} release in smooth muscle contraction. Inhibition of mitochondrial Ca^{2+} uptake may also elicit contraction. Takeo and Sakanashi (1985) estimated the mitochondrial Ca^{2+} uptake activity of the coronary artery to be 250 nmol Ca^{2+} /mg protein/10 min. Kowarski et al. (1985) analyzed subcellular Ca^{2+} concentrations in rabbit main pulmonary artery smooth muscle cells by electron probe X-ray microanalysis and estimated the mitochondrial Ca^{2+} to be 2.2 mmol/kg dry weight, and this was not changed after the muscle was exposed to norepinephrine. In contrast, the central SR can accumulate larger amounts of Ca^{2+} , and norepinephrine released Ca^{2+} from the SR. The relative sizes of the central SR and mitochondrial Ca^{2+} pools in relaxed tissue were about 20:1. In rabbit portal vein, smooth muscle was loaded with Na^+ for 3 h in a K^+ -free, ouabain-containing solution, after which rapid $\text{Na}^+/\text{Ca}^{2+}$ exchange was induced by Na^+ -free solution (Broderick and Somlyo, 1987). This procedure induced a large transient contraction accompanied by a large increase in $[\text{Ca}^{2+}]_i$ which was taken up by mitochondria.

Grover and Samson (1986) compared affinity characteristics of the Ca^{2+} pumps toward Ca^{2+} in various subcellular organelles isolated from pig coronary artery. The K_m value was 0.91 μM for plasma membrane, 0.58 μM for endoplasmic reticulum, and as high as 7.1 μM for mitochondria. $^{45}\text{Ca}^{2+}$ uptake experiments showed that high K^+ depolarization increases mitochondrial Ca^{2+}

uptake (see section II.B.2.). Ueno (1985) examined the mobilization of $^{45}\text{Ca}^{2+}$ in the saponin-permeabilized smooth muscle cell of the porcine coronary artery and found the minimum $[\text{Ca}^{2+}]_i$ required for the ATP-dependent Ca^{2+} uptake by the SR and mitochondria was about 20 nM and 1 μM , respectively. In saponin-permeabilized primary cultured rat aortic smooth muscle cells, Yamamoto and Van Breemen (1986) reported that mitochondrial $^{45}\text{Ca}^{2+}$ uptake appeared only in the presence of nonphysiologically high concentrations of Ca^{2+} (10 μM and higher). Stout (1991) also examined $^{45}\text{Ca}^{2+}$ uptake in saponin-permeabilized rat caudal artery and found that mitochondrial Ca^{2+} content increased only when the free Ca^{2+} concentration exceeded 3.1 μM .

Although these observations suggest the lack of involvement of mitochondria in the decrease in $[\text{Ca}^{2+}]_i$ in smooth muscle, Drummond and Fay (1996) reported that, in the voltage-clamped single stomach smooth muscle cells of *Bufo marinus*, the rate of Ca^{2+} extrusion from the cytosol following depolarizing pulses was reduced by more than 50% by cyanide or carbonyl cyanide *p*-trifluoromethoxy-phenylhydrazone. The inhibitor of both mitochondrial Ca^{2+} uniporter and ryanodine receptor, ruthenium red, produced a similar result while the ATP synthetase inhibitor, oligomycin, had no effect, indicating that the effect is not due to inhibition of Ca^{2+} -ATPase resulting from ATP insufficiency. This result suggests that mitochondria may play a significant role in removing Ca^{2+} from the cytoplasm in toad smooth muscle.

Glycolysis (glycogenolysis) is stimulated not only by inorganic phosphate and ADP, which activate phosphofructokinase, but also by Ca^{2+} and calmodulin, which activate phosphorylase *b* kinase. Since reduced pyridine nucleotides, located both in the cytoplasm and mitochondria, and oxidized flavoproteins, located specifically in the inner mitochondrial membrane, are fluorescent substances, it is possible to fluorometrically measure redox states in cells. As shown in fig. 3, reduced pyridine nucleotides and oxidized flavoproteins increased in response to spontaneous mechanical activities in guinea pig taenia coli (Ozaki et al., 1988), indicating that large oxidation-reduction potentials are generated across the mitochondrial membrane during contractions. The amount of reduced pyridine nucleotides is closely correlated with force of contractions in guinea pig ileum (Shimizu et al., 1991). Interestingly, flavoprotein fluorescence started to increase 0.5–1 s before the initiation of contraction, and this time course corresponded to the change in $[\text{Ca}^{2+}]_i$. Furthermore, Ca^{2+} sensitivity was in the order of flavoprotein fluorescence > pyridine nucleotide fluorescence > muscle contraction (fig. 3). Chance (1965) has observed that Ca^{2+} increased the rate of respiration and electron transport of mitochondria. Furthermore, the intra-mitochondrial key enzymes for oxidative metabolism such as dehydrogenases were activated by micromolar concentrations of Ca^{2+} (see

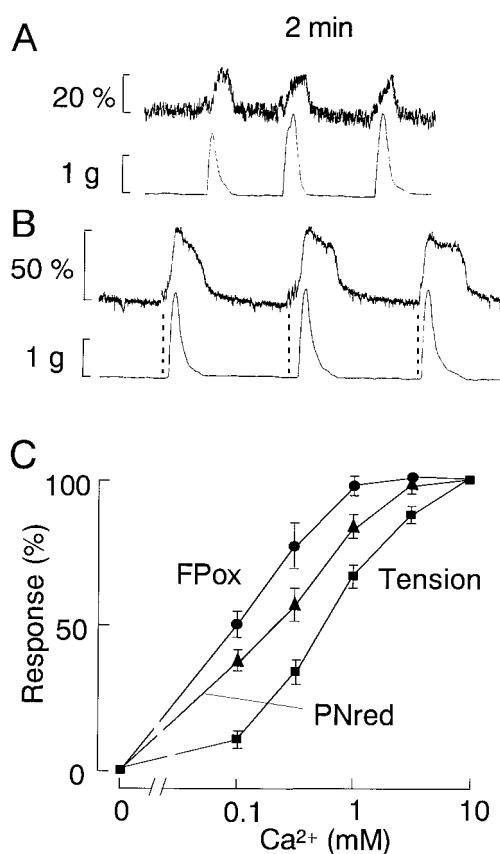

FIG. 3. Changes in the fluorescence of reduced pyridine nucleotides (PNred) (A) and oxidized flavoproteins (FPox) (B) during spontaneous contraction in guinea pig taenia coli. PNred and FPox fluorescence are shown by relative intensity of fluorescence taking the basal fluorescence as 100%. FPox started to increase before the initiation of contraction. (C): The effects of external Ca^{2+} concentration on PNred fluorescence, FPox fluorescence, and tension development in the 45.4 mM K^+ -depolarized taenia coli. Responses induced by 10 mM Ca^{2+} was taken as 100%. The Ca^{2+} sensitivity of each response was in the order of FPox > PNred > muscle contraction. (Modified from Ozaki et al., 1988).

Balaban, 1990). These findings suggest that the $[\text{Ca}^{2+}]_i$ directly activates three different mechanisms, cytoplasmic glycolysis, mitochondrial oxidation of flavoproteins, and contractile elements in cytoplasm.

Rizzuto et al. (1992, 1994) have developed molecularly engineered Ca^{2+} -sensitive photoproteins and applied this to study mitochondrial Ca^{2+} dynamics. In HeLa cells and bovine endothelial cells, mitochondrial Ca^{2+} increased rapidly upon stimulation with IP_3 -generating agonists such as ATP, carbachol, and histamine. Monitoring the level of NAD(P)H fluorescence suggested that the changes in mitochondrial Ca^{2+} were sufficiently large to induce a rapid activation of mitochondrial dehydrogenases.

These observations suggest that contractile stimulations increase the Ca^{2+} concentration not only in cytoplasm but also in the mitochondria. Calcium ion stimulates ATP production by mitochondria before it is triggered by energy consumption of contractile ele-

ments. Mitochondria may also serve as a Ca^{2+} sink under pathophysiological conditions where $[\text{Ca}^{2+}]_i$ increases above micromolar concentrations.

E. Calcium Distribution and Function

1. *Noncontractile calcium compartment.* Most of the data obtained from simultaneous measurement of $[\text{Ca}^{2+}]_i$ and contraction confirm that there is a positive correlation between these two parameters and that smooth muscle contraction occurs following an increase in $[\text{Ca}^{2+}]_i$. However, some small dissociations were identified. In some types of smooth muscle, agonists induced larger contractions than predicted from the increase in $[\text{Ca}^{2+}]_i$. This kind of dissociation may be explained by Ca^{2+} sensitization of contractile elements. In contrast, relaxants related to cyclic AMP and cyclic GMP decrease contractile force without decreasing $[\text{Ca}^{2+}]_i$ or with only a small decrease in $[\text{Ca}^{2+}]_i$, possibly by an attenuation of Ca^{2+} sensitivity of the contractile elements. However, some kinds of dissociations are explained neither by the changes in Ca^{2+} sensitivity nor by artifacts of $[\text{Ca}^{2+}]_i$ measurements.

a. *AEQUORIN SIGNAL AND FURA-2 SIGNAL.* The Ca^{2+} signal obtained with aequorin was different from that predicted from contractile data in smooth muscle. Agonist-induced sustained contractions were accompanied by large and transient increases followed by only the small sustained increases in the aequorin signal (see section II.C.1.). The transient increase in the aequorin signal, which was due to both Ca^{2+} release and Ca^{2+} influx, was rapidly desensitized by repeated applications of agonist, although contractile tension did not change. When muscle strips were left unstimulated for 2.5–13 h, the transient increase in the aequorin signal returned (Rembold and Murphy, 1988b; Abe et al., 1995). Although the high K^+ -induced sustained contraction was accompanied by a sustained increase in the aequorin signal due to Ca^{2+} influx, repeated applications of high K^+ also gradually attenuated the aequorin signal without changing the magnitude of the contraction, and a 13-h resting period was needed for complete recovery of the aequorin signal (Abe et al., 1995). Although the changes in aequorin signals are much larger than the changes in $[\text{Ca}^{2+}]_i$ (see section II.C.1.), dissociation between aequorin signals and contractions are evident. In contrast, the fura-2 signal did not desensitize, and there was much better correlation between the fura-2 signal and contraction. These results indicate that a part of the aequorin signal, stimulated either by Ca^{2+} release or Ca^{2+} influx, does not represent $[\text{Ca}^{2+}]_i$ regulating the contractile elements.

Karaki (1989a) suggested that the difference between the aequorin signal and the fura-2 signal may arise from the inhomogeneous or focal increases in $[\text{Ca}^{2+}]_i$. In swine carotid artery, Rembold and co-workers (Rembold et al., 1995; Van Riper et al., 1996; Rembold, 1996) compared the aequorin signal and the fura-2 signal and

found that the ratio of the aequorin signal and the fura-2 signal changed depending upon the types of stimulation employed and that contraction is more closely correlated with the fura-2 signal. From these results, they concluded that the aequorin/fura-2 ratio can be used as an indicator of the focal increase in $[\text{Ca}^{2+}]_i$. Using this method, they found that histamine-induced Ca^{2+} release resulted in the focal increases in $[\text{Ca}^{2+}]_i$ in the absence of external Ca^{2+} . Histamine-induced increase in $[\text{Ca}^{2+}]_i$ was accompanied by increased MLC phosphorylation and contraction. Caffeine elicited similar focal increase of $[\text{Ca}^{2+}]_i$ in the presence of external Ca^{2+} . However, caffeine elicited only a small increase in MLC phosphorylation and small contraction. A focal $[\text{Ca}^{2+}]_i$ increase was also observed when the external Ca^{2+} was restored in muscle treated with Ca^{2+} -free solution or when $\text{Na}^+/\text{Ca}^{2+}$ exchange was inhibited by decreasing the external Na^+ concentration. These changes were accompanied by neither MLC phosphorylation nor contraction. These results suggest that increase in $[\text{Ca}^{2+}]_i$ is localized to a region distant from the contractile apparatus under these conditions. Only histamine increased MLC phosphorylation possibly because it increases Ca^{2+} sensitivity of MLC phosphorylation (see section III.A.).

b. *INHIBITION OF SARCOPLASMIC RETICULUM CALCIUM ACCUMULATION AND ACTIVATION OF CALCIUM ENTRY.* Inhibition of SR function is expected to increase $[\text{Ca}^{2+}]_i$ by three different mechanisms. The first mechanism is inhibition of SR Ca^{2+} uptake and resulting increase in $[\text{Ca}^{2+}]_i$ near the SR. In rabbit inferior vena cava, inhibition of SR functions by caffeine, thapsigargin or ryanodine increased the steady-state $[\text{Ca}^{2+}]_i$ (Chen et al., 1992; Chen and Van Breemen, 1993). In guinea pig ureter (Maggi et al., 1995), inhibition of SR Ca^{2+} uptake by cyclopiazonic acid enhanced the contractions evoked by electrical stimulation or low- Na^+ medium. Inhibition of SR Ca^{2+} uptake augmented contractions also in rabbit aorta (Van Breemen et al., 1985), bovine coronary artery (Sturek et al., 1992) and guinea pig ureter (Maggi et al., 1995) (see section II.E.3.). In ferret portal vein (Abe et al., 1996), in contrast, inhibition of SR Ca^{2+} uptake by cyclopiazonic acid increased $[\text{Ca}^{2+}]_i$ measured with aequorin without changing contractions induced by norepinephrine or high K^+ . However, depletion of SR Ca^{2+} by ryanodine and caffeine did not have such an effect, suggesting that the increase in $[\text{Ca}^{2+}]_i$ is due to inhibition of SR Ca^{2+} uptake but not to increased Ca^{2+} influx by activation of CRAC. Also, in rat urinary bladder, Munro and Wendt (1994) measured $[\text{Ca}^{2+}]_i$ with fura-2 and reported that cyclopiazonic acid augmented the increase in $[\text{Ca}^{2+}]_i$ induced by carbachol and high K^+ without changing contraction. From these results, Abe et al. (1995, 1996) suggested that there are two Ca^{2+} compartments in the smooth muscle cell, a compartment containing contractile elements (contractile compartment) and another compartment unrelated to contractile elements (noncontractile compartment) (fig.

4). On stimulation, Ca^{2+} concentration in the contractile compartment may increase to a level high enough to stimulate MLC kinase but not so high as to consume aequorin rapidly. In contrast, the Ca^{2+} concentration in the noncontractile compartment may increase so much that aequorin in this compartment is rapidly consumed. These two compartments may be separated by a diffusion barrier and, during a resting period, aequorin may slowly diffuse from the contractile compartment to the noncontractile compartment and thus restore the full aequorin signal. The noncontractile compartment may be located near the SR, and the Ca^{2+} concentration in this compartment may be regulated not only by Ca^{2+} influx but also by SR Ca^{2+} uptake. Calcium ion in this compartment cannot reach the contractile compartment because of a diffusion barrier and sequestration by the SR.

The second SR-mediated mechanism to increase $[\text{Ca}^{2+}]_i$ is to deplete SR Ca^{2+} and activate Ca^{2+} entry through CRAC (see section II.D.2.). In rat aorta, ryanodine increased $[\text{Ca}^{2+}]_i$ measured with fura-2 and muscle tone, both of which were insensitive to nifedipine (Hisayama et al., 1990). In ferret portal vein, in contrast, cyclopiazonic acid induced a sustained increase in $[\text{Ca}^{2+}]_i$ measured with aequorin without inducing contraction (Abe et al., 1996). In rat mesenteric artery,

ryanodine and cyclopiazonic acid induced a sustained increase in $[\text{Ca}^{2+}]_i$ measured with fura-2 without inducing contraction (Naganobu and Ito, 1994; Naganobu et al., 1994). In rat urinary bladder, cyclopiazonic acid also increased $[\text{Ca}^{2+}]_i$ measured with fura-2 without inducing contraction (Munro and Wendt, 1994). There appears to be tissue-specific differences in the coupling between CRAC and contraction.

The third SR-mediated mechanism to increase $[\text{Ca}^{2+}]_i$ is membrane depolarization resulted from inhibition of the Ca^{2+} -activated K^+ channels (see section II.D.). Depletion of SR Ca^{2+} by ryanodine or cyclopiazonic acid increased $[\text{Ca}^{2+}]_i$ and induced contraction, both of which were inhibited by verapamil in rat femoral artery (Kojima et al., 1994) and guinea pig ileum (Uyama et al., 1993).

c. STIMULANT-DEPENDENT DISSOCIATION. In rat aorta, norepinephrine induced an initial large increase in $[\text{Ca}^{2+}]_i$ due to Ca^{2+} release followed by a sustained increase due to Ca^{2+} influx. Initial Ca^{2+} release was accompanied by a corresponding increase in IP_3 formation (Manolopoulos et al., 1991; Ahn et al., 1992; Pijuan et al., 1993) and transient contraction (Sato et al., 1988a; Karaki et al., 1988a). Endothelin-1 acted on the ET_A receptor and increased IP_3 formation (Huang et al., 1990b) and $[\text{Ca}^{2+}]_i$ in a manner similar to norepinephrine. However, the initial increase in $[\text{Ca}^{2+}]_i$ was not accompanied by contraction (Sakata et al., 1989; Ozaki et al., 1989; Huang et al., 1990a) or MLC phosphorylation (Harada et al., 1994, 1996). In contrast, the ET_A receptor-mediated Ca^{2+} influx, observed several minutes after the addition of endothelin-1, was accompanied by a large increase in MLC phosphorylation and contraction (Harada et al., 1994, 1996). Similar dissociation between Ca^{2+} release and contraction was reported in vascular smooth muscle stimulated with prostaglandin $\text{F}_{2\alpha}$ (Ozaki et al., 1990c; Dorn et al., 1992; Kurata et al., 1993). Simultaneous applications of norepinephrine and endothelin-1 induced larger Ca^{2+} release than that induced by either of the agonists alone, although the magnitude of transient contraction was similar to that induced by norepinephrine alone (our unpublished observation), suggesting that endothelin-1 does not have an inhibitory effect on contractile elements including an activation of MLC phosphatase. These results suggest that Ca^{2+} release induced by some agonists is not coupled to MLC phosphorylation and contraction, possibly because some agonists release Ca^{2+} in the direction of a contractile compartment whereas other agonists release Ca^{2+} in the direction of a noncontractile compartment. Hisayama et al. (1990) reported that Ca^{2+} release induced by prostaglandin $\text{F}_{2\alpha}$, which was not accompanied by contraction, was insensitive to ryanodine whereas Ca^{2+} release induced by caffeine or phenylephrine, which was accompanied by transient contraction, was sensitive to ryanodine. These results suggest that there are two types of Ca^{2+} stores; one of which (sensitive to

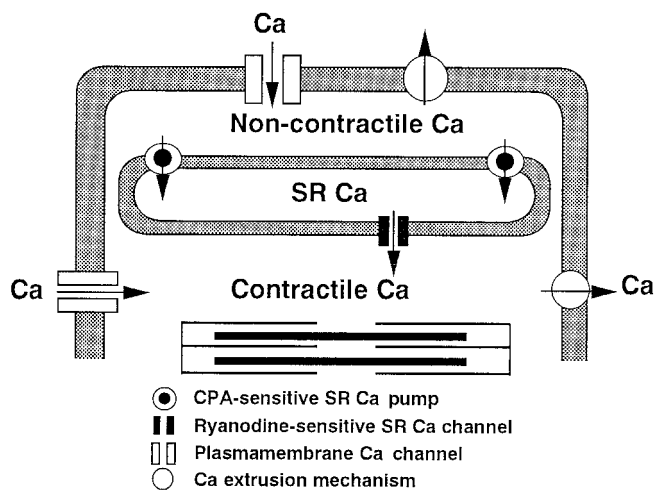

FIG. 4. Two Ca^{2+} compartments model (modified from Abe et al., 1996). The major Ca^{2+} compartment in the smooth muscle cell is the contractile compartment. In addition, there is a small Ca^{2+} compartment between plasmalemma and the SR that does not contain contractile elements (noncontractile compartment). Communication between these two compartments is restricted, and aequorin cannot move freely between these compartments. Calcium ion in this compartment also cannot reach the contractile compartment because of a diffusion barrier and sequestration by the SR. Inhibition of SR Ca^{2+} pump by cyclopiazonic acid increased $[\text{Ca}^{2+}]_i$ in the noncontractile compartment with little effect on the contractile Ca^{2+} compartment. In contrast, depletion of the SR by ryanodine and caffeine inhibited the agonist-induced transient increase in $[\text{Ca}^{2+}]_i$ in contractile compartment with little effect on $[\text{Ca}^{2+}]_i$ in the noncontractile compartment. Rates of decrease in contraction and $[\text{Ca}^{2+}]_i$ were affected neither by cyclopiazonic acid nor by ryanodine and caffeine.

phenylephrine, caffeine and ryanodine) supplies Ca^{2+} only to the contractile compartment whereas the other (sensitive only to prostaglandin $\text{F}_{2\alpha}$) supplies Ca^{2+} only to the noncontractile compartment.

d. NONSELECTIVE CATION CHANNEL. ATP has been shown to increase Ca^{2+} influx through the nonselective cation channel (Benham and Tsien, 1987; Benham, 1992). In rat basilar artery, an agonist of the P_2 purinoceptor, ATP, induced contraction following an increase in $[\text{Ca}^{2+}]_i$ by both releasing Ca^{2+} and increasing Ca^{2+} influx through the non-L-type Ca^{2+} channel (Zhang et al., 1995). In rat aorta (Kitajima et al., 1993, 1994, 1996a), ATP also induced a larger increase in $[\text{Ca}^{2+}]_i$ than that induced by high K^+ mainly by Ca^{2+} influx and partly by Ca^{2+} release. The ATP-induced increase in $[\text{Ca}^{2+}]_i$ was accompanied by a smaller increase in MLC phosphorylation and a smaller contraction than those induced by high K^+ -stimulated $[\text{Ca}^{2+}]_i$. In swine carotid artery (Rembold et al., 1991), ATP also induced a larger increase in $[\text{Ca}^{2+}]_i$ measured with aequorin, and a smaller increase in MLC phosphorylation and contraction than that induced by histamine. In mouse urinary bladder (Boland et al., 1993), ATP inhibited carbachol-induced contraction with little effect on $[\text{Ca}^{2+}]_i$. ATP also inhibited norepinephrine-induced contraction in rat aorta with little inhibitory effect on $[\text{Ca}^{2+}]_i$, although the inhibition was very small and dissociation between $[\text{Ca}^{2+}]_i$ and contraction is not explained by this mechanism (Kitajima et al., 1996a). These results suggest that the increases in $[\text{Ca}^{2+}]_i$ (due not only to Ca^{2+} release but also to Ca^{2+} influx) elicited by some agonists do not increase MLC phosphorylation and contraction.

e. CYCLIC ADENOSINE 3',5'-MONOPHOSPHATE. In rat aorta (Abe and Karaki, 1989) and toad stomach (Williams and Fay, 1986), forskolin or isoproterenol decreased $[\text{Ca}^{2+}]_i$ measured with fura-2 and quin2, both of which preferentially detect $[\text{Ca}^{2+}]_i$ in bulk cytoplasm rather than the localized high Ca^{2+} compartments. Morgan and Morgan (1984a) observed that, in high K^+ -depolarized strips of ferret portal vein, isoproterenol produced either no change or an increase in $[\text{Ca}^{2+}]_i$ measured with aequorin during smooth muscle relaxation. Only in the presence of very high concentrations of isoproterenol (greater than $0.1 \mu\text{M}$) was a decrease in $[\text{Ca}^{2+}]_i$ detectable. Both papaverine and forskolin also caused relaxation of the muscle while $[\text{Ca}^{2+}]_i$ either did not change or increased. In bovine trachea (Takuwa et al., 1988), isoproterenol, forskolin, and vasoactive intestinal peptide induced the sustained increases in the resting $[\text{Ca}^{2+}]_i$ measured with aequorin by increasing Ca^{2+} influx, which was not inhibited by Ca^{2+} channel blockers. In A7r5 cells, isoproterenol or forskolin increased Ca^{2+} currents by increasing single-channel activity in cell-attached patches (Marks et al., 1990). In bovine trachea (Felbel et al., 1988), isoproterenol increased $[\text{Ca}^{2+}]_i$ measured with fura-2, and the increase in $[\text{Ca}^{2+}]_i$ was inhibited by nitrendipine and me-

thoxyverapamil. Also, in bovine trachea (Tajimi et al., 1995), forskolin augmented the high K^+ -induced increase in $[\text{Ca}^{2+}]_i$, measured with fura-2 and inhibited the contraction. These results suggest that cyclic AMP increases $[\text{Ca}^{2+}]_i$ in a noncontractile compartment in bovine trachea. This possibility was confirmed in a more direct manner. Observing Ca^{2+} distribution by confocal microscopy in single airway smooth muscle cells loaded with fura-2, Yamaguchi et al. (1995) found that isoproterenol decreased inner cytosolic $[\text{Ca}^{2+}]_i$ and increased peripheral $[\text{Ca}^{2+}]_i$, suggesting that there are two Ca^{2+} compartments in the cell and $[\text{Ca}^{2+}]_i$ in these compartments are regulated independently. Consistent with these findings, cyclic AMP stimulated K^+ channels which are sensitive to $[\text{Ca}^{2+}]_i$ near the plasmalemma (see section II.E.3.).

f. SUBPLASMALEMAL CALCIUM COMPARTMENT. In single smooth muscle cells of rabbit jejunum and rabbit ear artery, Benham and Bolton (1986) found that caffeine stimulated rapid discharge of transient K^+ outward currents. Subsequently, there were numerous reports describing the role of SR Ca^{2+} on spontaneous transient outward currents (STOCs) in smooth muscle (e.g., Ohya et al., 1987; Sakai et al., 1988; Kitamura et al., 1989; Hume and LeBlanc, 1989; Desilets et al., 1989; Stehno-Bittel and Sturek, 1992; Suzuki et al., 1992; Uyama et al., 1993; Lee and Earm, 1994; Kim et al., 1995b). Since activators of both IICR and CICR increase STOCs and agents known to deplete Ca^{2+} stores abolish STOCs after a possible initial increase of STOC discharge, it is now widely accepted that Ca^{2+} released from the SR activates the K^+ channel (for reviews see Kuriyama et al., 1995; Bolton and Imaizumi, 1996). However, the $[\text{Ca}^{2+}]_i$ in average cytoplasm increased only after STOCs were activated (Stehno-Bittel and Sturek, 1992; Sturek et al., 1992; Imaizumi et al., 1996a,b), indicating that the Ca^{2+} needed to activate STOCs was not detected by fluorescent Ca^{2+} indicators such as fura-2 and indo-1.

Membrane depolarization activates the K^+ channel by increasing $[\text{Ca}^{2+}]_i$. The increase in $[\text{Ca}^{2+}]_i$ is due not only to Ca^{2+} influx but also to Ca^{2+} release from the SR by CICR (see Bolton and Imaizumi, 1996; Imaizumi et al., 1996a). However, CICR does not play an important role in inducing contraction in smooth muscle (Iino, 1989). Furthermore, Imaizumi et al. (1993, 1996a, b) found that, although caffeine-induced Ca^{2+} release resulted in the activation of K^+ channels and contraction, Ca^{2+} release induced by 9-methyl-7-bromo-eudistomin (MBED) activated the K^+ channel without inducing contraction. Since pretreatment with MBED did not change the subsequent caffeine-induced contraction, it seems likely that there are MBED-sensitive and MBED-insensitive SR. MBED may release Ca^{2+} toward the subplasmalemmal Ca^{2+} space to activate K^+ channel but not toward the cytoplasm, where contractile proteins exist.

2. *Calcium sparks, waves, oscillations, and gradients.* Using digital imaging techniques and new intracellular Ca^{2+} indicators, it became possible to examine the two- or three-dimensional distribution of Ca^{2+} in the cell. Results of these experiments revealed that Ca^{2+} distributes unevenly in the cell, supporting the suggestion by the functional studies.

a. **CALCIUM SPARKS.** The spontaneous local increases in $[\text{Ca}^{2+}]_i$, called Ca^{2+} sparks, were first found in rat cardiac cells as measured with a laser scanning confocal microscope and the fluorescent Ca^{2+} indicator, fluo-3 (Cheng et al., 1993). Calcium sparks appeared to result from the spontaneous opening of single SR Ca^{2+} -release channels (see Taylor, 1994). Although the Ca^{2+} sparks were usually nonpropagating, some sparks triggered propagating waves of increased $[\text{Ca}^{2+}]_i$ when the Ca^{2+} content of the SR was increased. In cerebral artery single smooth muscle cell, Nelson et al. (1995) found the ryanodine-sensitive, spontaneous local increases in $[\text{Ca}^{2+}]_i$ (Ca^{2+} sparks) just under the surface membrane, and suggested that Ca^{2+} sparks may activate K^+ channels, hyperpolarizes the membrane and relaxes the muscle.

b. **CALCIUM WAVES AND OSCILLATIONS.** In the eggs of a fresh water fish, medaka, fertilization started a wave of high $[\text{Ca}^{2+}]_i$ at the animal pole (where the sperm entered) and then traversed the egg as a shallow and narrow-wide band which vanished at the antipode some minutes later (Gilkey et al., 1978). This kind of Ca^{2+} wave occurs in all eggs investigated so far (Jaffe, 1993). Injection of IP_3 , but not Ca^{2+} , induced a Ca^{2+} wave (DeLisle and Welsh, 1992; Lechleiter and Clapham, 1992), and inhibition of the IP_3 receptor abolished the Ca^{2+} wave (Miyazaki et al., 1992), suggesting that Ca^{2+} release originates from an IP_3 -sensitive channel. Calcium waves and oscillations observed in non-muscle cells have been reviewed by Thomas et al. (1996).

In primary rat aortic smooth muscle cells, the spontaneous increases in $[\text{Ca}^{2+}]_i$ were observed (Bobik et al., 1988; Weissberg et al., 1989). In cultured smooth muscle cells of the human internal mammary artery (Neylon et al., 1990), the thrombin-induced rise in $[\text{Ca}^{2+}]_i$ began in a discrete region typically located close to the end of the cell. Subsequently, this region of elevated $[\text{Ca}^{2+}]_i$ expanded until $[\text{Ca}^{2+}]_i$ was elevated throughout the cell. In some cells, the $[\text{Ca}^{2+}]_i$ rise began at both ends and collided midway. The rate of spreading of the region of elevated $[\text{Ca}^{2+}]_i$ traversed the length of most cells within about 5 s. In confluent vascular smooth muscle cells, Simpson and Ashley (1989b) found spontaneous transients and elevations in $[\text{Ca}^{2+}]_i$ as well as maintained oscillations. The oscillations had a periodicity of 6–9 s and were not present in single cells. They also reported that endothelin-1 but not vasopressin induced oscillations which were inhibited by nifedipine, and suggested that these oscillations are at least partly dependent upon the L-type Ca^{2+} channels (Simpson and Ash-

ley, 1989a). Similar oscillations have been reported in cultured vascular smooth muscle cells (Wier and Blatter, 1991; Gillespie et al., 1992c) and intestinal smooth muscle cells (Publicover et al., 1992; Komori et al., 1993, 1996; Ohata et al., 1993; Iino et al., 1993; Kawanishi et al., 1994; Kohda et al., 1996).

In cultured rat aortic smooth muscle cells (Johnson et al., 1991), there were small regions in the cytoplasm in which $[\text{Ca}^{2+}]_i$ was elevated (hot spot). The initial rise in $[\text{Ca}^{2+}]_i$, triggered by stimulants, emanated from the hot spot and spread evenly throughout the cytoplasm. The increases in $[\text{Ca}^{2+}]_i$ lasted for about 60 s and then retreated back to the original hot spot. In half of the population of the cells, discrete oscillations in $[\text{Ca}^{2+}]_i$ occurred after the initial $[\text{Ca}^{2+}]_i$ peak. In rat tail artery (Iino et al., 1994a), both nerve stimulation and norepinephrine elicited oscillations of $[\text{Ca}^{2+}]_i$ that propagated within the cell in the form of waves. Since ryanodine inhibited the oscillations, SR Ca^{2+} release appears to be responsible for the oscillations.

In cultured guinea pig ileum longitudinal smooth muscle cells (Ohta et al., 1993), thapsigargin-sensitive spontaneous $[\text{Ca}^{2+}]_i$ oscillations were observed. Oscillations in $[\text{Ca}^{2+}]_i$ were evoked in intact cultured human vascular smooth muscle cells and persisted in nominally Ca^{2+} -free media (Gillespie et al., 1992c). This indicated the existence of a cyclical mobilization of Ca^{2+} from internal stores. A7r5 cells generated the spontaneous increases in $[\text{Ca}^{2+}]_i$ that were abolished by removal of extracellular Ca^{2+} or addition of nimodipine, indicating that Ca^{2+} entry through the L-type Ca^{2+} channels is required for Ca^{2+} spiking (Byron and Taylor, 1993, but see Hughes and Schachter, 1994). In this cell, neither ryanodine nor thapsigargin did affect Ca^{2+} spiking, indicating that mobilization of intracellular Ca^{2+} stores is not necessary for spike generation. In longitudinal muscle strips of the rat uterus (Kasai et al., 1994), cyclopiazonic acid completely suppressed oxytocin-induced Ca^{2+} release without changing oxytocin-induced rhythmic contractions, suggesting that the Ca^{2+} stores are not directly involved in uterine rhythmic contractions.

In canine gastric muscle (Ozaki et al., 1992c), acetylcholine transiently increased tissue levels of IP_3 and increased the amplitudes of the plateau phase of slow waves and associated Ca^{2+} transients and phasic contractions. High K^+ , ATP, ionomycin, thapsigargin, and caffeine also increased basal $[\text{Ca}^{2+}]_i$. However, each of these compounds reduced the amplitude and duration of slow waves. Results suggest that generation of IP_3 may provide negative-feedback control of Ca^{2+} influx during slow waves, possibly through activation of Ca^{2+} -activated K^+ channels, tending to reduce the amplitude of phasic contractile activity in gastric muscles. In cultured A7r5 cells (Berman and Goldman, 1992), there was an inverse relationship between SR Ca^{2+} content and evoked IP_3 synthesis, suggesting that SR Ca^{2+} may serve as a signal that modulates sarcolemmal IP_3 for-

mation. The increase in $[Ca^{2+}]_i$ elicited by IP_3 -induced Ca^{2+} release may inactivate IP_3 -gated channels to decrease Ca^{2+} release, and such a negative-feedback pathway may be responsible for the Ca^{2+} oscillation (Komori et al., 1993; Iino et al., 1993; Zholos et al., 1994; Carl et al., 1996).

Stimulations evoke an action potential in some, but not all vascular smooth muscles. Action potentials were only recorded from myogenic (resistant) vessels and in some elastic arteries (see Kuriyama et al., 1995). In these arteries, therefore, another mechanism of Ca^{2+} oscillation may be repetitive generation of action potentials followed by a transient opening of the L-type Ca^{2+} channels and a transient increase in $[Ca^{2+}]_i$. Cyclic appearance of trains of action potentials may be related to variations in $[Ca^{2+}]_i$, possibly via inactivation of Ca^{2+} -dependent K^+ channels (Himpens et al., 1990). Liu et al. (1995) showed that cyclopiazonic acid and caffeine decreased the pacemaker frequency in the canine colon. However, ryanodine did not affect the pacemaker frequency, which indicates that a ryanodine-sensitive store is not coupled to the biochemical clock. In A7r5 cells (Wu et al., 1995), vasopressin caused an initial rapid rise and a delayed increase in $[Ca^{2+}]_i$. However, in the presence of an inhibitor of K^+ channel, tetraethylammonium chloride, vasopressin consistently triggered sustained Ca^{2+} oscillations which were preceded by a large peak of $[Ca^{2+}]_i$. In the confluent monolayers of cultured vascular smooth muscle (Missiaen et al., 1994a), cells are electrically coupled and spontaneous discharges of action potential and subsequent $[Ca^{2+}]_i$ oscillations were synchronized among all the cells. However, individual cells in the monolayer responded to arginine-vasopressin with different latencies, suggesting that agonist-induced $[Ca^{2+}]_i$ oscillations are asynchronous. Also in tail artery isolated from young rats (Iino et al., 1994a), relatively low concentrations of norepinephrine could induce oscillations of $[Ca^{2+}]_i$ propagated within the cell in the form of a wave and that there was no synchronization in $[Ca^{2+}]_i$ oscillations between the cells. Cells responded to stimulation in an all-or-none manner, and increasing the concentration of norepinephrine increased the frequency of oscillation but not the peak concentration of the $[Ca^{2+}]_i$ transient. Since ryanodine abolished the $[Ca^{2+}]_i$ oscillation, the authors suggested that sustained contraction of smooth muscle is due to summation of $[Ca^{2+}]_i$ oscillations produced by Ca^{2+} release from the SR and that graded responses to different levels of stimulation may be accomplished not by a graded response within each smooth muscle cell but by a graded number of cells within the vascular wall. Low concentrations of norepinephrine do not change membrane potential in rat tail artery (Itoh et al., 1983), and this may be the reason for asynchronous changes in $[Ca^{2+}]_i$.

c. CALCIUM GRADIENTS. Using one- and two-dimensional models, Kargacin and Fay (1991) suggested that

high Ca^{2+} concentrations can develop near the plasmalemma in smooth muscle cells as a result of Ca^{2+} influx or Ca^{2+} release. Kargacin (1994) also suggested that the Ca^{2+} concentration in restricted diffusion spaces between the plasmalemma and the SR may increase up to several μM and this increase persists for 100–200 ms.

Goldman et al. (1989) examined the spatial distribution of $[Ca^{2+}]_i$ in arterial myocytes and found that the intracellular $[Ca^{2+}]_i$ was relatively uniformly distributed in resting cells. During norepinephrine-evoked contractions, $[Ca^{2+}]_i$ increased with much more heterogeneous distribution. Upon removal of norepinephrine, discrete regions of elevated $[Ca^{2+}]_i$ were observed throughout the recovered cells. Similarly, activating Na^+/Ca^{2+} exchange elicited a rise in $[Ca^{2+}]_i$ with discrete areas of high $[Ca^{2+}]_i$. In A7r5 cells (Goldman et al., 1990), the distribution of apparent $[Ca^{2+}]_i$ was heterogeneous; $[Ca^{2+}]_i$ was lowest in the nucleus and highest in the organelle-rich perinuclear region, while the surrounding cytoplasmic area (containing relatively few organelles) had intermediate $[Ca^{2+}]_i$.

Etter et al. (1994) loaded the toad stomach smooth muscle with C18-fura-2, a fura-2 molecule conjugated to a lipophilic alkyl chain which inserts into cell membranes. They showed that Ca^{2+} influx increased $[Ca^{2+}]_i$ near the plasmalemma much earlier than $[Ca^{2+}]_i$ measured globally by fura-2. Using FFP18, a Ca^{2+} indicator designed to selectively monitor near-membrane $[Ca^{2+}]_i$, Etter et al. (1996) further showed that during the membrane depolarization-induced Ca^{2+} influx near-membrane $[Ca^{2+}]_i$ rose faster and reached micromolar levels at early times when the cytoplasmic $[Ca^{2+}]_i$, recorded using fura-2, had risen to only a few hundred nanomolars. High speed series of digital images of $[Ca^{2+}]_i$ showed that near-membrane $[Ca^{2+}]_i$, reported by FFP18, rose within 20 msec, peaked at 50 to 100 msec, and then declined. Calcium concentrations reported by fura-2 rose slowly and continuously during membrane depolarization. It was also shown that Ca^{2+} release from the SR increased $[Ca^{2+}]_i$, measured with the Ca^{2+} -activated K^+ channel activity (see section II.E.3.), much earlier than the average cytosolic $[Ca^{2+}]_i$ measured with fura-2 in bovine and guinea pig coronary arteries (Stehno-Bittel and Sturek, 1992; Ganitkevich and Isenberg, 1996a). Calcium concentrations in subplasmalemmal space seem to oscillate because STOCs were found to oscillate (Komori et al., 1993; Lee and Earm, 1994; Kang et al., 1995).

d. NUCLEAR CALCIUM. Williams et al. (1985, 1987) found that $[Ca^{2+}]_i$ in smooth muscle cytoplasm, nucleus and the SR are clearly different. The $[Ca^{2+}]_i$ in the nucleus and the SR were greater than in the cytoplasm and these gradients were abolished by Ca^{2+} ionophores, suggesting that difference in $[Ca^{2+}]_i$ is not due to artifact derived from different K_d values in cytoplasm and nucleus. When external Ca^{2+} was increased above normal in the absence of ionophores, cytoplasmic $[Ca^{2+}]_i$

increased but nuclear $[Ca^{2+}]_i$ did not. Himpens et al. (1992a, b, 1994) also reported that nuclear $[Ca^{2+}]_i$ in smooth muscle is regulated independently from bulk cytoplasmic $[Ca^{2+}]_i$. Agonists increase nuclear $[Ca^{2+}]_i$ by an influx of Ca^{2+} from perinuclear stores and/or by a release of intranuclear Ca^{2+} , possibly mediated by a process dependent on phosphatidylinositol metabolism. Fujihara et al. (1993) also reported that, in cultured rat aortic cells, arginine-vasopressin increased the nuclear and cytosolic $[Ca^{2+}]_i$. However, caffeine and ryanodine greatly attenuated the increase in $[Ca^{2+}]_i$ in both of the regions. Thus, nuclear $[Ca^{2+}]_i$ appears to be regulated independently of cytoplasmic $[Ca^{2+}]_i$ by gating mechanisms in the nuclear envelope.

3. Role of localized calcium. The Ca^{2+} -sensitive processes at cell membranes including ion channels, ion pump and enzymes are activated *in situ* or *in vitro* by Ca^{2+} 10–100 times higher than $[Ca^{2+}]_i$ measured during stimulation in intact cells (see Etter et al., 1996). It has been suggested that increased $[Ca^{2+}]_i$ in the subplasmalemmal restricted diffusion space could 1) facilitate the coupling of Ca^{2+} influx into SR Ca^{2+} release (CICR), 2) provide a mechanism for the regulation of stored Ca^{2+} that does not affect the contractile state of smooth muscle, and 3) locally activate the specific signal transduction pathway before or without activating other Ca^{2+} -dependent pathways in the central cytoplasm of the cell (Rasmussen et al., 1987; Karaki, 1989a, 1990; Kargacin, 1994; Etter et al., 1994, 1996; Van Breemen et al., 1995).

a. REGULATION OF ION CHANNELS, PUMP, AND EXCHANGER. Calcium ion activates large-conductance K^+ channels, Cl^- channels and nonselective cation channels, whereas it inhibits delayed rectifier K^+ channels and inactivates Ca^{2+} channels (see Carl et al., 1996). To regulate these ion channels, it is necessary that the increases in $[Ca^{2+}]_i$ occur in a region of close apposition of SR membrane and plasmalemma about 100 nm wide (see Bolton and Imaizumi, 1996). Thus, one of the roles of localized Ca^{2+} may be to regulate membrane potential by modulating open probabilities of ion channels (Vogalis et al., 1992). Nelson et al. (1995) suggested that Ca^{2+} sparks indirectly cause vasodilation through activation of K^+ channels, but have little direct effect on spatially averaged $[Ca^{2+}]_i$ which regulates contractile elements. In guinea pig trachea (Hiramatsu et al., 1994; Kume et al., 1994), forskolin opened Ca^{2+} -activated K^+ channel. Cyclic AMP-induced increase in noncontractile Ca^{2+} (see section II.E.1.) may be responsible for this effect. ATP inhibited the peak inward Ca^{2+} current in guinea pig urinary bladder (Schneider et al., 1991), suggesting that the ATP increased $[Ca^{2+}]_i$ in the subplasmalemma area and inactivated Ca^{2+} entry. High concentrations of Ca^{2+} activate Ca^{2+} -ATPase to stimulate Ca^{2+} extrusion or sequestration. Furthermore, high $[Ca^{2+}]_i$ will activate Na^+/Ca^{2+} exchange and transport Ca^{2+} outside the cell.

b. SUPERFICIAL BUFFER BARRIER AND CALCIUM EXTRUSION. In rabbit aorta (Van Breemen et al., 1985), high K^+ -induced $^{45}Ca^{2+}$ influx did not induce contraction until the SR is filled with Ca^{2+} . In rabbit inferior vena cava (Chen et al., 1992; Chen and Van Breemen, 1993), discharging SR Ca^{2+} with either caffeine or norepinephrine before stimulation of Ca^{2+} influx induced a delay of 30 to 70 sec between the increase in $[Ca^{2+}]_i$ and development of force. This delay was abolished by the application of caffeine. From these and other results, Van Breemen and co-workers (Van Breemen and Saida, 1989; Chen et al., 1992; Chen and Van Breemen, 1993; Van Breemen et al., 1995) suggested the existence of three Ca^{2+} compartments in the cytoplasm (fig. 5). The first space is the central cytoplasmic space beneath the superficial SR and surrounding the contractile elements. Calcium ion in this compartment is directly coupled to contraction. The second compartment is junctional space where the SR and plasmalemma are closely apposed leaving a narrow space from which diffusion is restricted in a direction parallel to the plasmalemma. Calcium ion released from the SR to this compartment is extruded from the cell without escaping to the central cytoplasm. The third compartment is restricted subplasmalemmal space, wider than junctional space and in more free diffusion exchange with the central cytoplasm.

When depleted of Ca^{2+} , superficial SR takes up a significant fraction of Ca^{2+} entering the cell, decreases the amount of Ca^{2+} reaching the central cytoplasm, and

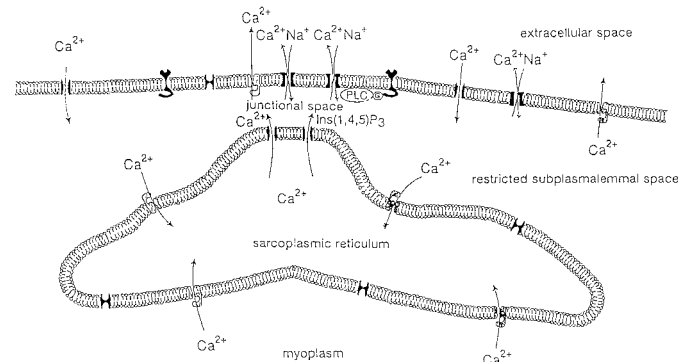

FIG. 5. The superficial buffer barrier system suggested by Van Breemen et al. (1995). Calcium entering the cell is partially sequestered by the superficial SR from a restricted subplasmalemmal space. This process is modulated by various agonists. Vasodilators, which raise cyclic nucleotide levels, will enhance buffering and decrease Ca^{2+} entry in the deeper myoplasm, while Ca^{2+} -mobilizing agonists, which increase IP_3 , will shortcut the superficial buffer barrier and enhance the flow of Ca^{2+} into the myoplasm. The combination of basal IP_3 production and cytoplasmic IP_3 phosphatase may generate an IP_3 gradient near the plasmalemma, which would activate IP_3 receptors and subsequently ryanodine receptors in the junctional regions. The resulting vectorial Ca^{2+} release would raise Ca^{2+} near the Na^+/Ca^{2+} exchange to facilitate extrusion of Ca^{2+} coupled to Na^+ influx. This mode spatially separates Ca^{2+} unloading at the junctional regions from Ca^{2+} buffering in the restricted subplasmalemmal space. The resulting peripheral Ca^{2+} cycle generates a variable Ca^{2+} gradient in the subplasmalemmal space. (Reprinted with permission from Elsevier Science.)

attenuates the contraction (see Van Breemen and Saida, 1989; Sturek et al., 1992). Serving as a superficial buffer barrier to Ca^{2+} entry is the primary action of the superficial SR (Chen and Van Breemen, 1993; Van Breemen et al., 1995). Measuring $[\text{Ca}^{2+}]_i$ with aequorin and fura-2, Rembold et al. (1995) showed that in swine carotid artery $[\text{Ca}^{2+}]_i$ in subplasmalemmal space is greater than $[\text{Ca}^{2+}]_i$ in central cytoplasm. Stimulation with histamine increased $[\text{Ca}^{2+}]_i$ homogeneity possibly because of opening the SR Ca^{2+} channel, decreasing the buffering capacity of the SR, and increasing the amount of Ca^{2+} reaching the central cytoplasm. It has also been suggested that the SR releases Ca^{2+} preferentially toward the junctional space between the SR and plasmalemma (Stehno-Bittel and Sturek, 1992; Chen and Van Breemen, 1993; Van Breemen et al., 1995). Such a vectorial Ca^{2+} release may be initiated by a gradient of IP_3 concentration generated by basal synthesis of IP_3 in the plasmalemma. Thus, the Ca^{2+} release channel in the SR facing plasmalemma may be activated by IP_3 while the channels located away from the plasmalemma would be exposed to only subthreshold concentrations of IP_3 . Release of Ca^{2+} into the junctional space would then raise the $[\text{Ca}^{2+}]_i$, which induces Ca^{2+} -induced Ca^{2+} release to further increase the local $[\text{Ca}^{2+}]_i$. Since the $\text{Na}^+/\text{Ca}^{2+}$ exchanger was demonstrated to be in close proximity to the surface SR (Moore et al., 1993), this locally elevated $[\text{Ca}^{2+}]_i$ would activate $\text{Na}^+/\text{Ca}^{2+}$ exchange in the Ca^{2+} extrusion mode. The Ca^{2+} unloading mechanism, which would depend on the IP_3 gradient at the junctional space, spatially separates it from the buffering action in the restricted subplasmalemmal space (fig. 5).

c. REGULATION OF PROLIFERATION. Inhibition of Ca^{2+} influx by Ca^{2+} channel blockers (Haller, 1993; Waters and Lesperance, 1994; Kruse et al., 1994; Luscher et al., 1995) or estrogen (Farhat et al., 1996) inhibited cell proliferation. Furthermore, release of Ca^{2+} from the SR was necessary for smooth muscle cell proliferation (Short et al., 1993; Waldron et al., 1994). These results suggest that the increase in $[\text{Ca}^{2+}]_i$ resulting from not only Ca^{2+} influx but also from SR Ca^{2+} release plays an important role in cell proliferation. Endothelin-1 (Sakata et al., 1989), angiotensin II (Kruse et al., 1994), platelet-activating factor (Ko et al., 1993; Kim et al., 1995a), prostaglandin $\text{F}_{2\alpha}$ (Ozaki et al., 1990c; Hisayama et al., 1990) and ATP (Kitajima et al., 1993, 1994, 1996a) increased $[\text{Ca}^{2+}]_i$ by Ca^{2+} release and Ca^{2+} influx (through the L-type Ca^{2+} channel, nonselective cation channel, and/or capacitance Ca^{2+} entry pathway). All of these agonists are also known to activate proliferation (Bobik and Campbell, 1993; Jahan et al., 1996). Furthermore, both of the effects of these GTP-binding protein-coupled vasoactive agents to induce contraction and to activate proliferation may be mediated by a tyrosine kinase pathway (Hollenberg, 1994a, b). Since endothelin-1, prostaglandin $\text{F}_{2\alpha}$ and ATP increase noncontractile $[\text{Ca}^{2+}]_i$, it is tempting to suggest that role

of the noncontractile Ca^{2+} may be to activate smooth muscle cell proliferation.

III. Changes in Calcium Sensitivity

A. Increase in Calcium Sensitivity

Simultaneous measurements of $[\text{Ca}^{2+}]_i$ and contraction showed that receptor agonists and phorbol esters induced greater contractions than high K^+ at a given $[\text{Ca}^{2+}]_i$ (see section II.C.). Changes in Ca^{2+} sensitivity are observed not only in tonic-type smooth muscle such as large arteries but also phasic-type smooth muscle such as gastrointestinal muscle. In tonic muscle, agonists induce a sustained increase in Ca^{2+} sensitivity. In phasic muscle, in contrast, temporal changes in Ca^{2+} sensitivity are observed (Ozaki et al., 1991b, 1993). Agonists transiently increase Ca^{2+} sensitivity followed by a decrease, resulting in a phasic contraction. The differences between phasic and tonic types of smooth muscle are summarized by Himpens (1992), Ozaki and Karaki (1993) and Sanders and Ozaki (1994).

A technique developed to make small holes in the smooth muscle cell membrane using the saponin analog, β -escin, or *Staphylococcus aureus* α -toxin made it possible to precisely regulate the cytosolic concentrations of Ca^{2+} as well as other substances with molecular weights less than 1000 without disrupting receptor/signal transduction pathways and the contractile machinery. In these preparations, Ca^{2+} induced contraction in the presence of ATP. This contraction was augmented by norepinephrine and other receptor agonists in the presence of fixed concentration of Ca^{2+} . Since GTP was necessary for the agonist-induced augmentation of Ca^{2+} -induced contraction, and since GTP γ S showed effects similar to those of agonists, it was proposed that agonists increase the Ca^{2+} sensitivity of contractile elements by activating a GTP-binding protein (Nishimura et al., 1988, 1990; Kitazawa et al., 1989, 1991b). Phorbol esters also augmented Ca^{2+} -induced contraction although GTP was not necessary for the effects of phorbol esters. Augmentation of Ca^{2+} -induced contractions elicited by receptor agonist or phorbol ester was inhibited by the C kinase inhibitor, calphostin C or 1-(5-isoquinolinesulfonyl)-2-methylpiperazine (H-7) (Nishimura et al., 1992; Takizawa et al., 1993; Katsuyama and Morgan, 1993; Jiang et al., 1994; Satoh et al., 1994). These results suggested that C kinase activation is necessary to induce Ca^{2+} sensitization. On the other hand, Oishi et al. (1992) reported that C kinase inhibitor did not prevent the Ca^{2+} sensitization induced by acetylcholine in stomach smooth muscle. Moreover, the desensitization of the C kinase activity by long exposure to phorbol ester completely inhibited the Ca^{2+} sensitization induced by phorbol esters but not that induced by receptor agonists (Hori et al., 1993b). This result suggests that Ca^{2+} sensitivity of contractile elements may be increased by pathways dependent on and independent of C kinase.

This result was confirmed by others (Itoh et al., 1994c; Rapoport et al., 1995; Fujita et al., 1995; Jensen et al., 1996). Recently, isoforms of C kinase in arteries were immunologically examined and Ca^{2+} -dependent α -isoform of C kinase and/or Ca^{2+} -independent δ - and ϵ -isoforms of C kinase were found to be necessary for the phorbol ester-mediated contractions (Khalil et al., 1992; Ohanian et al., 1996). Furthermore, Jensen et al. (1996) reported that although both phorbol ester-induced and GTP-binding protein-coupled Ca^{2+} sensitization of force are mediated by increased MLC phosphorylation, it is likely that α -, β -, ϵ -, and θ -isoforms of C kinases do not play an essential role in the GTP-binding protein-coupled mechanism.

Smooth muscle contraction is explained by Ca^{2+} -dependent activation of MLC kinase and phosphorylation of MLC (Kamm and Stull, 1985; Hartshorne, 1987). Observed variations in the relation between $[\text{Ca}^{2+}]_i$ and contraction is explained at least partly by variations in the relationship between $[\text{Ca}^{2+}]_i$ and MLC phosphorylation but not between MLC phosphorylation and contraction (Rembold, 1990). There are four proposed mechanisms for changes in the Ca^{2+} sensitivity of phosphorylation (fig. 6).

The first mechanism is that increases in $[\text{Ca}^{2+}]_i$ activate Ca^{2+} -calmodulin-dependent protein kinase II which phosphorylates MLC kinase thus decreasing its activity (Stull et al., 1990; Tansey et al., 1992). Agonists would somehow inhibit this negative feedback pathway. However, studies in both airway and vascular smooth

muscles showed that increased $[\text{Ca}^{2+}]_i$ increased phosphorylation of MLC kinase independent of the stimulation, suggesting that this possibility is not likely under conditions of physiological muscle stimulation (Tang et al., 1992; Van Riper et al., 1995).

Somlyo and co-workers (Somlyo et al., 1989; Kitazawa et al., 1991a, b) have asserted a second hypothesis for altering the Ca^{2+} sensitivity of MLC phosphorylation by agonist-induced phosphatase inhibition. It was also reported that $\text{GTP}\gamma\text{S}$ may increase the Ca^{2+} sensitivity of contractile elements by directly inhibiting protein phosphatase (Kubota et al., 1992). There are two mechanistic hypotheses for phosphatase inhibition. The first mechanism is that agonists activate phospholipase A_2 to cleave arachidonic acid from membrane phospholipids which, in turn, inhibits MLC phosphatase. Arachidonic acid enhanced Ca^{2+} -induced contractions in α -toxin permeabilized smooth muscle and inhibited MLC phosphatase in vitro (Gong et al., 1992). It has also been reported that arachidonic acid release is associated with inhibition of dephosphorylation of MLC in intact smooth muscle tissue (Gong et al., 1995). The second mechanism is that receptor agonists activate rho, a small GTP binding protein, which may directly or indirectly inhibit MLC phosphatase (Hirata et al., 1992; Fujita et al., 1995; Noda et al., 1995; Itagaki et al., 1995; Kokubu et al., 1995; Otto et al., 1996; Gong et al., 1996). In permeabilized smooth muscle, C3 exoenzyme isolated from *Clostridium botulinum*, which is known to selectively inactivate rho p21 by ADP ribosylation, inhibited the augmentation of Ca^{2+} -induced contractions elicited by $\text{GTP}\gamma\text{S}$ or receptor agonists. It has been reported that phosphorylation of the large subunit of MLC phosphatase decreased phosphatase activity and that there was an endogenous protein kinase that phosphorylated the large subunit (Trinkle-Mulcahy et al., 1995; Ichikawa et al., 1996). Recently, Matsui et al. (1996) reported that a novel rho-associated serine/threonine kinase (rho kinase) phosphorylated the myosin-binding subunit of MLC phosphatase in vitro. Kimura et al. (1996) also reported that rho kinase phosphorylated myosin-binding subunit of MLC phosphatase and inhibited its activity. Furthermore, over-expression of rho or activation of rho in NIH 3T3 cells increased phosphorylation of both subunit of MLC phosphatase and MLC. In swine vascular smooth muscle, Nishimura et al. (1996) reported the messenger RNA expression of rho A and rho kinase. These findings indicate that receptor agonists may activate the rho/rho kinase pathway, phosphorylate the large subunit of the phosphatase, and inhibit phosphatase activity. Phorbol esters also decrease the rate of relaxation and MLC dephosphorylation, suggesting that C kinase increases Ca^{2+} sensitivity through the inhibition of MLC phosphatase (Itoh et al., 1993; Masuo et al., 1994). There are six phosphorylation sites for C kinase in the myosin-binding subunit although the effects of phosphorylation are not known (Chen et al., 1995; Shimizu et al., 1994).

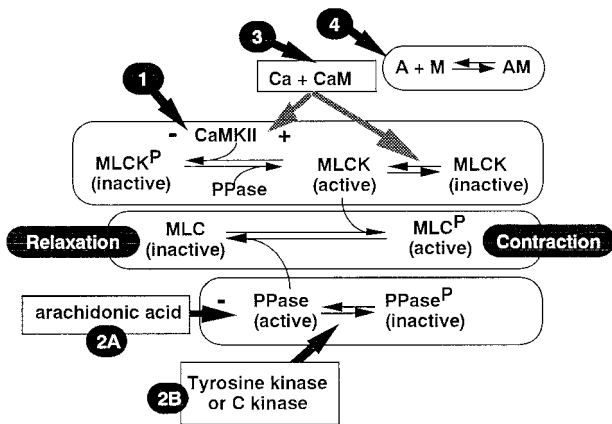

FIG. 6. Mechanisms of agonist-induced Ca^{2+} sensitization in smooth muscle. Stimulation of a receptor increases $[\text{Ca}^{2+}]_i$, activates MLC kinase (MLCK), phosphorylates MLC, and induces contraction. This process is modulated by four different mechanisms. The first mechanism is the inhibition of Ca^{2+} -calmodulin-dependent protein kinase II (CaMKII), which phosphorylates MLC kinase and inhibits its activity (1). The second mechanism is inhibition of MLC phosphatase (PPase) (2). Arachidonic acid, produced by receptor-mediated activation of phospholipase A_2 , may directly inhibit phosphatase (2A). C kinase and tyrosine kinase may also inhibit phosphatase by inhibiting the endogenous inhibitor of phosphatase (2B). The third mechanism is to increase free calmodulin concentration (3). The fourth mechanism is to activate actin independently of MLC phosphorylation (4).

A third factor which may affect Ca^{2+} sensitivity is the availability of calmodulin. It is well known that concentration of the Ca^{2+} -calmodulin complex can regulate the MLC kinase activity, and that Ca^{2+} concentration is regulated. However, it was postulated that the large intracellular pool of calmodulin is freely diffusible and saturating for kinase activity in living cells. From experiments of fluorescent recovery after photobleaching, however, it was found that only 5% of total calmodulin is freely diffusible in resting cells (Tansey et al., 1994; Luby-Phelps et al., 1995). Zimmermann et al. (1995) also estimated from flash photolysis studies with caged Ca^{2+} and caged ATP that the endogenous calmodulin concentration available in the resting state was of less than micromolar. Furthermore, Luby-Phelps et al. (1995) found that the diffusion coefficient and the percent mobile fraction of calmodulin were increased when $[\text{Ca}^{2+}]_i$ was elevated. These results suggest that endogenous calmodulin is compartmentalized into several intracellular pools with different affinities and is mobilized in a Ca^{2+} -dependent manner. In neuroblastoma cells, it has been reported that carbachol stimulated a translocation of calmodulin from membrane to cytosol (Mangels and Gnegy, 1992). Thus, it is possible that not only Ca^{2+} concentration but also calmodulin concentration is regulated, and that changes in calmodulin concentration determine the Ca^{2+} sensitivity of MLC phosphorylation.

The agonist-induced increase in Ca^{2+} sensitivity may also result from activation of an actin-linked regulatory mechanism (Tansey et al., 1990; Stull et al., 1991; Sato et al., 1992; Hori et al., 1992; Karaki, 1995a, b, c; Kamm and Grange, 1996). In the absence of external Ca^{2+} , prostaglandin $\text{F}_{2\alpha}$, endothelin-1, and phorbol esters induced sustained contractions in muscles in which Ca^{2+} stores had been depleted (Sato et al., 1992; Hori et al., 1992; Katsuyama and Morgan, 1993). These contractions were accompanied by increases in the rate of cross-bridge cycling of actomyosin although MLC phosphorylation stayed at a resting level (Sato et al., 1992; Hori et al., 1992). Wortmannin, an inhibitor of MLC kinase, inhibited the MLC phosphorylation with only partial inhibition of contractions induced by prostaglandin $\text{F}_{2\alpha}$ in the presence of external Ca^{2+} (Takayama et al., 1996). Takayanagi and coworkers also showed that the contractions mediated by the α_1 -adrenoceptor were not inhibited by a MLC kinase inhibitor, KT5926 [(8R*, 9S*, 11S*)-(9-hydroxy-9-methoxycarbonyl-8-methyl-14-*n*-propoxy-2,3,9,10-tetrahydro-8,11-epoxy,1*H*-8*H*-11*H*-2,7b,11a-triazadibenzo[*a,g*]cycloocta[*cde*]trinden-1-one] (Sato et al., 1995; Takayanagi et al., 1997). These results suggest that smooth muscle contraction is regulated not only by MLC phosphorylation but also by a phosphorylation-independent mechanism, possibly a mechanism linked to actin. The actin-linked mechanism may be more sensitive to Ca^{2+} than MLC kinase and activated by agonists in the presence of resting level of $[\text{Ca}^{2+}]_i$ (Karaki, 1995a, b, c). Actin-binding proteins such

as caldesmon (Sobue et al., 1981, 1982, 1991; Walsh, 1987, 1990), calponin (Takahashi et al., 1986, 1988; Nakamura et al., 1993; Ichikawa et al., 1993; Mino et al., 1995) and MLC kinase (Ebashi, 1990, 1991; Kohama et al., 1996) may be responsible for this regulatory mechanism (for review, see Kamm and Grange, 1996). Phosphorylation of caldesmon induced by mitogen-activated protein kinase was suggested to be one of the mechanisms of Ca^{2+} sensitization because the phosphorylation of caldesmon decreased its ability to inhibit actomyosin ATPase in vitro (Adam et al., 1989, 1992; Adam, 1996; Gerthoffer and Pohl, 1994). Khalil and Morgan (1993) also reported that the translocation of C kinase induced by phenylephrine was associated with transient translocation of cytosolic mitogen-activated protein kinase to the membrane before contraction and redistribution away to cytoplasm during contraction. They suggested a role for mitogen-activated protein kinase in the signal transduction cascade linking C kinase activation to smooth muscle contractility. In contrast to these reports, Nixon et al. (1995) reported that phosphorylation of caldesmon by recombinant mitogen-activated protein kinase (p42mapk) had no effect on resting tone or Ca^{2+} sensitivity of contraction in permeabilized smooth muscle.

Itoh et al. (1994b,d) showed that calponin inhibited actin-activated Mg^{2+} -ATPase activity with a proportional increase in its binding to actomyosin and also attenuated Ca^{2+} -induced contractions in permeabilized arterial strips in the presence or absence of calmodulin. Calponin, when phosphorylated by C kinase, reduced both its ability to bind to actomyosin and its inhibitory action on actomyosin Mg^{2+} -ATPase. The phosphorylated calponin also had no effect on the maximum Ca^{2+} -induced contraction in permeabilized smooth muscle, suggesting that these actions of calponin are specific. Calponin attenuated the Ca^{2+} -independent contraction observed in MLC thiophosphorylated strips, or on application of trypsin-treated MLC kinase. A calponin peptide (calponin Phe-173-Arg-185), which inhibits the binding of calponin to actin, inhibited the action of calponin and enhanced the contraction induced by submaximal concentrations of Ca^{2+} in permeabilized vascular smooth muscle. Unlike calmodulin, this peptide enhanced the Ca^{2+} -induced contraction without a corresponding increase in the level of MLC phosphorylation. These results suggest that calponin decreases the Ca^{2+} sensitivity of smooth muscle at a given level of MLC phosphorylation. However, Adam et al. (1995) showed that caldesmon but not calponin was phosphorylated during contractions of swine carotid arteries stimulated with histamine, high K^+ or phorbol ester.

Agonists increase Ca^{2+} sensitivity of contractile elements in vascular (De Feo and Morgan, 1985; Sato et al., 1988a; Karaki et al., 1988a; Sakata et al., 1989; Takayanagi and Onozuka, 1989; Rembold, 1990), tracheal (Gerthoffer et al., 1989; Ozaki et al., 1990b) and gastric

smooth muscle (Ozaki et al., 1991b, 1992a, 1993; Oishi et al., 1992). However, Ca^{2+} sensitivity is not increased in uterine (Sakata and Karaki, 1992; Szal et al., 1994; Kim et al., 1995a) and chicken gizzard smooth muscle (Anabuki et al., 1994). In rat anococcygeus muscle (Shimizu et al., 1995) and guinea pig taenia coli (Mitsui and Karaki, 1990, 1993), the increase in Ca^{2+} sensitivity was observed in permeabilized muscle but not in intact muscle. Because the mechanism of Ca^{2+} sensitization is not yet understood, the reasons for these tissue differences are not clear.

B. Decrease in Calcium Sensitivity and Inhibition of Agonist-Induced Increase

The increases in cyclic AMP due to β -adrenergic stimulation and in cyclic GMP due to nitric oxide, atrial natriuretic peptides and nitro-vasodilators result in inhibition of contraction in intact smooth muscle (see Bulbring and Tomita, 1987; Kamm and Stull, 1989; Ignarro and Kadowitz, 1985; Ignarro, 1989). One of the mechanisms for the relaxation induced by these cyclic nucleotides was considered to be a decrease in $[\text{Ca}^{2+}]_i$ (see McDaniel et al., 1994; Kotlikoff and Kamm, 1996). Simultaneous measurements of $[\text{Ca}^{2+}]_i$ and muscle force, however, showed that these cyclic nucleotides more strongly inhibited contraction than $[\text{Ca}^{2+}]_i$, suggesting that cyclic nucleotides caused muscle relaxation by desensitization of contractile elements to Ca^{2+} (Karaki et al., 1988b; Abe and Karaki, 1989, 1992b; Gunst and Bandyopadhyay, 1989; Tajimi et al., 1991; Chen and Rembold, 1992; McDaniel et al., 1992; Ozaki et al., 1992b, 1993; Kwon et al., 1993; Yamagishi et al., 1994). Furthermore, cyclic AMP and cyclic GMP inhibited Ca^{2+} -induced contraction and agonist-induced augmentation of Ca^{2+} -induced contraction in permeabilized smooth muscle (Nishimura and Van Breemen, 1989; Ozaki et al., 1992a, b; Tajimi et al., 1995). Paglin et al. (1988) found that, in rabbit aorta, atrial natriuretic peptide uncoupled MLC phosphorylation from the increase in $[\text{Ca}^{2+}]_i$ elicited by angiotensin II or histamine. Sue-matsu et al. (1991a) reported that forskolin significantly shifted the Ca^{2+} -force curve and the Ca^{2+} -MLC-phosphorylation curve to the right without changing the phosphorylation-force curve. These results suggest that both cyclic AMP and cyclic GMP increase the Ca^{2+} requirement for MLC phosphorylation (Ca^{2+} desensitization of MLC phosphorylation) either by inhibiting MLC kinase or activating MLC phosphatase. Phosphorylation of MLC kinase induced by cyclic AMP-dependent protein kinase would decrease the affinity of MLC kinase for Ca^{2+} , resulting in a decrease of MLC kinase activity at a given Ca^{2+} in vitro (Adelstein et al., 1978; de Lanerolle et al., 1984). Recent work, however, demonstrated that the cyclic AMP-induced phosphorylation of MLC kinase is not the physiological mechanism for cyclic AMP-induced smooth muscle relaxation (Miller et al., 1983; Stull et al., 1990; Tang et al., 1992; Van Riper et al.,

1995). Itoh et al. (1993) reported that a water-soluble forskolin, NKH477, activated MLC phosphatase in rat aorta. There are four phosphorylation sites in the smooth muscle phosphatase by A kinase (Shimizu et al., 1994), although the effects of phosphorylation on the phosphatase activity have not been defined.

Activation of G kinase did not decrease MLC kinase activity by phosphorylating MLC kinase (Nishikawa et al., 1984). Recently, it has also been reported that cyclic GMP inhibited Ca^{2+} -induced contraction accompanied by a decrease in MLC phosphorylation (Kitazawa et al., 1996; Wu et al., 1996). The rate of relaxation and dephosphorylation of MLC was accelerated by 8-bromocyclic GMP in permeabilized muscle, suggesting that cyclic GMP activates the MLC phosphatase via G kinase. However, it has also reported that cyclic AMP and cyclic GMP relaxed the contraction without a proportional change in MLC phosphorylation in intact (McDaniel et al., 1992) and permeabilized muscle preparations (Su et al., 1996). Furthermore, these cyclic nucleotides also inhibited the contractions that are dependent neither on Ca^{2+} nor on MLC phosphorylation elicited by receptor agonists and phorbol esters in the absence of external Ca^{2+} (Ozaki et al., 1990c; Tajimi et al., 1995). These results suggest that cyclic nucleotides inhibit not only MLC phosphorylation-dependent pathway but also -independent pathway regulating contractile elements, although the details of the inhibitory mechanisms are not yet understood.

IV. Effects of Pharmacological Agents

A. Activators and Inhibitors of Protein Kinases and Phosphatases

1. Myosin light chain kinase. Wortmannin is a potent inhibitor of smooth muscle MLC kinase produced by a fungal strain, *Talaromyces wortmannin* (Nakanishi et al., 1992). It inhibits MLC kinase at 10 nM to 1 μM concentrations without affecting A kinase, G kinase, C kinase and Ca^{2+} /calmodulin-dependent protein kinase II. However, it also inhibits phosphatidylinositol 3-kinase at concentrations lower than 10 nM (Okada et al., 1994). In rabbit aorta (Asano et al., 1995a), wortmannin inhibited high K^+ -induced contraction without changing $[\text{Ca}^{2+}]_i$. In rat aorta, Takayama et al. (1996) showed that wortmannin decreased MLC phosphorylation to resting level and inhibited contractions induced by high K^+ . However, wortmannin did not change the high K^+ -induced increase in $[\text{Ca}^{2+}]_i$. Wortmannin also decreased MLC phosphorylation to resting level in the presence of phenylephrine or prostaglandin $\text{F}_{2\alpha}$ without changing $[\text{Ca}^{2+}]_i$. In canine gastric antrum, wortmannin changed neither resting membrane potential nor spontaneous slow waves (Burke et al., 1996). These results suggest that wortmannin inhibited MLC kinase without changing Ca^{2+} mobilization. However, a part of the contraction induced by prostaglandin $\text{F}_{2\alpha}$ was not inhibited by

wortmannin (Takayama et al., 1996), suggesting that although contractions in rat aorta are due mainly to phosphorylation of MLC, another contractile mechanism exists which is not dependent on MLC phosphorylation or dependent only on resting level of MLC phosphorylation (Hori et al., 1992; Sato et al., 1992; Karaki, 1995a, b, c). Wortmannin also inhibited the release of human immunodeficiency virus type 1 from host cells by inhibiting myosin-actin interaction (Sasaki et al., 1995).

1-(5-Chloronaphthalene-1-sulfonyl)-1*H*-hexahydro-1,4-diazepine (ML-9) is also an inhibitor of MLC kinase (Ishikawa et al., 1988; Ishikawa and Hidaka, 1990). In endothelial cells, wortmannin and ML-9 inhibited bradykinin-induced Ca^{2+} influx (Watanabe et al., 1996). However, there is no report on the effect of ML-9 on $[\text{Ca}^{2+}]_i$ in smooth muscle. 1-[5-Isoquinoline-sulfonyl]-homopiperazine also inhibits MLC kinase (Seto et al., 1991). This compound inhibited contractions induced by high K^+ and norepinephrine with a small but significant decrease in $[\text{Ca}^{2+}]_i$ in rat aorta (Takizawa et al., 1993), suggesting that 1-[5-isoquinoline-sulfonyl]-homopiperazine inhibits not only MLC kinase but also Ca^{2+} channels. An antibiotic, NA0334, inhibits smooth muscle contraction by inhibiting MLC kinase (Kohama et al., 1991).

2. *A kinase.* The role of A kinase on smooth muscle contraction has been reviewed by Bulbring and Tomita (1987), Kamm and Stull (1989) and Kotlikoff and Kamm (1996). A kinase is activated by cyclic AMP produced by activation of adenylate cyclase. The β -adrenoceptor agonists and forskolin are widely used to activate this enzyme. Inhibitors of phosphodiesterase also increase cyclic AMP. The effects of these agents on Ca^{2+} movements in smooth muscle are variable.

As described in section II.E.1.e., cyclic AMP increases $[\text{Ca}^{2+}]_i$ in noncontractile compartment in ferret portal vein and bovine trachea. However, it relaxes smooth muscle by decreasing Ca^{2+} sensitivity of contractile element. In contrast to the above results, cyclic AMP decreases $[\text{Ca}^{2+}]_i$ in other types of smooth muscle. In longitudinal smooth muscle from guinea pig ileum (Parker et al., 1987), isoproterenol suppressed the spontaneous increase in $[\text{Ca}^{2+}]_i$ measured with fura-2, and reduced the resting $[\text{Ca}^{2+}]_i$. In ferret aorta (De Feo and Morgan, 1989), forskolin inhibited high K^+ -induced contraction accompanied by the decreases in both $[\text{Ca}^{2+}]_i$ and Ca^{2+} sensitivity. In canine trachea (Fujiwara et al., 1988), a β_2 -adrenoceptor agonist, procaterol, increased cyclic AMP, hyperpolarized the membrane and inhibited the increase in $[\text{Ca}^{2+}]_i$ induced by acetylcholine. In guinea pig trachea (Ito et al., 1995), isoproterenol produced relaxation, mainly by inhibiting Ca^{2+} influx. In cultured vascular smooth muscle cells (Hino et al., 1994), parathyroid hormone, forskolin and 3-isobutyl-1-methylxanthine decreased $[\text{Ca}^{2+}]_i$ measured with fura-2. In rat aortic smooth muscle cells (Ohoka et al., 1990), a cyclic AMP-specific phosphodiesterase inhibitor, loproprone hydrochloride (E-1020), increased the cyclic AMP and de-

creased $[\text{Ca}^{2+}]_i$. In rat aorta (Ahn et al., 1992), forskolin and dibutyryl cyclic AMP inhibited $^{45}\text{Ca}^{2+}$ influx due to norepinephrine without changing high K^+ -stimulated $^{45}\text{Ca}^{2+}$ influx. These results suggest that cyclic AMP-induced relaxation is caused by the cyclic AMP-mediated decrease in $[\text{Ca}^{2+}]_i$ due to indirect inhibition of the L-type Ca^{2+} channel, possibly mediated by activation of K^+ channels and resulting membrane hyperpolarization, and also inhibition of the receptor-coupled signal transduction.

In some types of smooth muscle, cyclic AMP decreases both $[\text{Ca}^{2+}]_i$ and Ca^{2+} sensitivity. In resting rat aorta (Abe and Karaki, 1989), forskolin decreased both muscle tension and $[\text{Ca}^{2+}]_i$ measured with fura-2. Furthermore, addition of forskolin during the sustained contractions induced by high K^+ or norepinephrine decreased contraction more strongly than $[\text{Ca}^{2+}]_i$. In the high K^+ -depolarized carotid artery (Chen and Rembold, 1992), forskolin also relaxed high K^+ -induced contraction without decreasing Ca^{2+} influx, which was measured with Mn^{2+} -induced fura-2-quenching or $[\text{Ca}^{2+}]_i$. The decreases in both $[\text{Ca}^{2+}]_i$ and Ca^{2+} sensitivity were elicited by the cyclic AMP-specific phosphodiesterase inhibitors, E-1020 in rat aorta (Tajimi et al., 1991), dibutyryl cyclic AMP and parathyroid hormone-related protein in rat aorta (Ishikawa et al., 1994), dibutyryl cyclic AMP in rat stomach (Ohta et al., 1992), and isoproterenol, forskolin, vasoactive intestinal peptide and calcitonin gene-related peptide (CGRP) in circular muscles of canine antrum (Ozaki et al., 1992b). In rat aorta, papaverine relaxed high K^+ -induced contraction accompanied by a decrease in $[\text{Ca}^{2+}]_i$ (Kaneda, T., personal communication). In rat aorta (Chang et al., 1991), a papaverine analog, *N*-(3',4'-dimethoxyphenylethyl)-4-methoxy phenylacetamide, inhibited high K^+ -induced contraction accompanied by a decrease in $[\text{Ca}^{2+}]_i$ and a decrease in Ca^{2+} sensitivity.

In swine common carotid media tissues, however, cyclic AMP does not seem to decrease Ca^{2+} sensitivity. McDaniel et al. (1991) showed that, in tissues precontracted with phenylephrine or histamine, forskolin increased cyclic AMP and elicited relaxation. These changes were accompanied by the decrease in $[\text{Ca}^{2+}]_i$ measured with aequorin as well as MLC phosphorylation. This relaxation was not associated with an alteration of the Ca^{2+} sensitivity of phosphorylation or of the dependence of stress on phosphorylation.

In primary (unpassaged) rat aortic smooth muscle cells, Lincoln et al. (1990) reported that forskolin inhibited the vasopressin-stimulated increase in $[\text{Ca}^{2+}]_i$. In repetitively passaged cells, however, forskolin by itself increased $[\text{Ca}^{2+}]_i$ by apparently stimulating Ca^{2+} uptake into the cell and had much smaller effects on inhibiting vasopressin-stimulated $[\text{Ca}^{2+}]_i$ elevations. Both primary and passaged smooth muscle cells contained A kinase. G kinase was greatly reduced or absent in passaged smooth muscle cells. The introduction of purified

G kinase into the cytoplasm of passaged cells prevented forskolin from elevating $[Ca^{2+}]_i$ and restored the capacity of forskolin to reduce vasopressin-stimulated Ca^{2+} mobilization. Similar effects were observed for isoproterenol in passaged smooth muscle cells. When introduced into cells, the active catalytic subunit of the A kinase did not lead to reductions in Ca^{2+} levels. These results suggest that cyclic AMP activates both A kinase and G kinase. Activation of G kinase by cyclic AMP leads to the reduction in $[Ca^{2+}]_i$ whereas activation of A kinase may only mediate the uptake of Ca^{2+} from extracellular sources. Also, in swine coronary arteries (Jiang et al., 1992), isoproterenol and forskolin activated both A kinase and G kinase whereas sodium nitroprusside and atrial natriuretic peptide activated G kinase without changing A kinase. In permeabilized rat mesenteric artery, both cyclic AMP and cyclic GMP decreased Ca^{2+} sensitivity by activating G kinase (Kawada et al., 1997). In contrast, cyclic GMP but not cyclic AMP activated the plasmalemmal Ca^{2+} pump (see section II.D.5.), suggesting that G kinase was not activated by cyclic AMP in these experiments.

These results suggest that cyclic AMP may increase $[Ca^{2+}]_i$ in the noncontractile compartment and either decrease or do not change $[Ca^{2+}]_i$ in the contractile compartment. In addition, cyclic AMP may decrease the Ca^{2+} sensitivity of the contractile elements. In some types of smooth muscle, either a decrease in the contractile $[Ca^{2+}]_i$ or a decrease in the Ca^{2+} sensitivity plays an important role whereas both of these mechanisms are important for relaxation in other types of smooth muscle. Also there may be a concentration-dependent differences in the mechanisms of action of cyclic AMP.

In isolated rat aorta (Abe and Karaki, 1992b), forskolin and dibutyryl cyclic AMP inhibited norepinephrine-induced contraction more strongly than high K^+ -induced contraction, and the contraction induced by lower concentrations of each stimulant was more sensitive to these inhibitors than that induced by higher concentrations. Forskolin and dibutyryl cyclic AMP inhibited the increases in muscle tension and $[Ca^{2+}]_i$. The inhibitory effects of forskolin and dibutyryl cyclic AMP were inversely proportional to $[Ca^{2+}]_i$ before the addition of these inhibitors. In DDT1MF-2 smooth muscle cells (Schachter et al., 1992), the simultaneous addition of norepinephrine and a selective A_1 -adenosine receptor agonist, cyclopentyladenosine, resulted in a synergistic increase in phosphoinositide hydrolysis. Buffering of $[Ca^{2+}]_i$ with the membrane-permeant Ca^{2+} chelator, quin2, blocked the potentiation and this effect was reversed by the addition of extracellular Ca^{2+} . Forskolin or dibutyryl cyclic AMP also blocked the action of the adenosine agonist to potentiate norepinephrine-stimulated phosphoinositide hydrolysis. This effect of cyclic AMP was less pronounced in the presence of elevated extracellular Ca^{2+} and was abolished in the presence of a Ca^{2+} ionophore. These results suggest that the inhib-

itory effects of cyclic AMP are antagonized by an increase in $[Ca^{2+}]_i$.

Mechanisms of relaxant effects mediated by cyclic AMP may be summarized as follows: 1) inhibition of the receptor-mediated signal transduction (Abdel-Latif, 1991; Schachter et al., 1992; Ahn et al., 1992) resulting in the inhibition of all the effects of agonists including Ca^{2+} release, Ca^{2+} influx and Ca^{2+} sensitization; 2) dissociation of contraction from MLC phosphorylation; 3) increase in SR Ca^{2+} uptake; 4) decrease in the Ca^{2+} sensitivity of MLC phosphorylation possibly by activating MLC phosphatase; and 5) increase in noncontractile $[Ca^{2+}]_i$ which may result in activation of K^+ channels and membrane hyperpolarization. A part of these effects may be mediated by G kinase but not by A kinase.

3. *G kinase.* Role of G kinase on smooth muscle contraction has been reviewed by Ignarro and Kadowitz (1985) and Kamm and Stull (1989). G kinase is activated by cyclic GMP produced by stimulation of guanylate cyclase by nitric oxide, atrial natriuretic peptide, and nitro-vasodilators. Effects of nitric oxide on Ca^{2+} movements will be described in section IV.E. Effects of G kinase on SR functions have been described in section II.D.5. Similar to A kinase, effects of G kinase on Ca^{2+} movements are diverse.

There are some reports indicating that the G kinase-mediated relaxation is due to a decrease in $[Ca^{2+}]_i$. In cultured rat aortic smooth muscle cells, Kai et al. (1987) reported that 8-bromo-cyclic GMP decreased $[Ca^{2+}]_i$ measured with fura-2 either in resting or in high K^+ -depolarized condition. In freshly isolated bovine tracheal smooth muscle cells, 8-bromo-cyclic GMP and the active fragment of G kinase, but not the catalytic subunit of A kinase, lowered carbachol-induced $[Ca^{2+}]_i$ measured with fura-2 (Felbel et al., 1988). In cultured vascular smooth muscle cells, atrial natriuretic peptide decreased both the resting level and the sustained elevation of $[Ca^{2+}]_i$ induced by angiotensin II and arginine-vasopressin (Hassid, 1986; Takeuchi et al., 1989a). In porcine coronary artery, Makujina et al. (1995) reported that sodium nitroprusside elicited reductions in muscle tension as well as in $[Ca^{2+}]_i$ measured with fura-2 in both high K^+ - and prostaglandin $F_{2\alpha}$ -contracted rings. In porcine coronary artery (Sato et al., 1989), a nitro compound, E-4701, or nitroglycerin inhibited the $[Ca^{2+}]_i$ elicited with acetylcholine. In canine tracheal smooth muscle contracted with acetylcholine or high K^+ , 3-morpholinopyridone caused a concentration-dependent decrease in force which was correlated with a concentration-dependent increase in cyclic GMP. Reductions in force were accompanied by the decreases in $[Ca^{2+}]_i$ measured with fura-2 (Jones et al., 1994). In ferret aorta, sodium nitroprusside caused relaxation of either the high K^+ - or phenylephrine-induced contraction solely by a decrease in $[Ca^{2+}]_i$ measured with aequorin with no change in Ca^{2+} sensitivity (Resnick et al., 1991).

Others also suggested that the decreases in both $[Ca^{2+}]_i$ and Ca^{2+} sensitivity are the important mechanisms. In ferret portal vein, Morgan and Morgan (1984a) reported that, when the muscles were relaxed either by decreasing the Ca^{2+} concentration in the bathing medium or by the addition of sodium nitroprusside, aequorin light and force fell together. However, sodium nitroprusside decreased force more strongly than aequorin light, indicating that sodium nitroprusside was relaxing the muscle by more than just decreasing $[Ca^{2+}]_i$. In rabbit aorta (Takuwa and Rasmussen, 1987), atrial natriuretic peptide inhibited the sustained phase of $[Ca^{2+}]_i$ measured with aequorin without inhibiting the transient increase in $[Ca^{2+}]_i$ elicited by histamine. In rat aorta, Sato et al. (1988a) and Karaki et al. (1988b) found that sodium nitroprusside inhibited the norepinephrine-induced increase in muscle tension, $^{45}Ca^{2+}$ uptake and $[Ca^{2+}]_i$ measured with fura-2, although the inhibitory effects on $^{45}Ca^{2+}$ influx and $[Ca^{2+}]_i$ were less than that on muscle contraction. In Ca^{2+} -free solution, sodium nitroprusside inhibited the norepinephrine-induced transient contraction more strongly than the increase in $[Ca^{2+}]_i$. Sodium nitroprusside also inhibited the high K^+ -induced contraction at concentrations higher than those needed to inhibit norepinephrine-induced contractions. Sodium nitroprusside inhibited the high K^+ -induced contraction with a smaller decrease in $[Ca^{2+}]_i$ and a smaller decrease in $^{45}Ca^{2+}$ uptake. In porcine coronary artery, Balwierczak (1991) also reported that nearly complete relaxation of high K^+ -induced contractions by sodium nitroprusside was accompanied by only a partial decrease in $[Ca^{2+}]_i$. These results suggest that sodium nitroprusside has multiple sites of action; to inhibit Ca^{2+} influx and Ca^{2+} release and also to decrease the Ca^{2+} sensitivity of the contractile elements.

Also, there are some reports showing that the G kinase-mediated relaxation is not accompanied by a decrease in $[Ca^{2+}]_i$. In cultured rat vascular smooth muscle cells, atrial natriuretic peptide did not inhibit the endothelin-1-induced increase in $[Ca^{2+}]_i$ although it inhibited the contraction induced by endothelin-1 (Suzuki et al., 1991). In canine coronary artery (Yanagisawa et al., 1989), nitroglycerin relaxed the high K^+ -induced contraction with no reduction of the increased $[Ca^{2+}]_i$. In swine carotid artery (Chen and Rembold, 1992), nitroglycerin attenuated the histamine-induced increases in Ca^{2+} influx, $[Ca^{2+}]_i$, and force. Nitroglycerin also relaxed the high K^+ -induced contraction, although Ca^{2+} influx and $[Ca^{2+}]_i$ remained high. In rat aorta, 8-bromocyclic GMP inhibited the high K^+ -induced contraction without changing $[Ca^{2+}]_i$ or $^{45}Ca^{2+}$ influx (Salomone et al., 1995).

These differences may be due partly to the concentration-dependent effects of nitro-vasodilators. Sato et al. (1988a) showed that sodium nitroprusside at 10 nM decreased $[Ca^{2+}]_i$ whereas it decreased both $[Ca^{2+}]_i$ and

Ca^{2+} sensitivity at 100 nM to 1 μ M. McDaniel et al. (1992) also showed that, in swine carotid arteries submaximally stimulated with histamine, sodium nitroprusside induced a proportional decrease in $[Ca^{2+}]_i$ and MLC phosphorylation, suggesting that the relaxation was at least partially induced by a decrease in $[Ca^{2+}]_i$ without a change in the Ca^{2+} sensitivity of phosphorylation. In tissues maximally stimulated with higher concentrations of histamine, sodium nitroprusside and nitroglycerin produced significant relaxations that were not associated with significant sustained reductions in $[Ca^{2+}]_i$ or MLC phosphorylation. With both submaximal and maximal histamine stimulation, nitro-vasodilators produced more substantial relaxation than that expected from the nitro-vasodilator-induced reduction in MLC phosphorylation.

Mechanisms of relaxant effects mediated by cyclic GMP are similar to those of cyclic AMP; 1) inhibition of the receptor-mediated signal transduction (Krall et al., 1988; Langlands and Diamond, 1990; Kajikuri and Kuriyama, 1990) resulting in the inhibition of all the effects of agonists including Ca^{2+} release, Ca^{2+} influx, and Ca^{2+} sensitization; 2) increase in SR Ca^{2+} uptake; 3) decrease in the Ca^{2+} sensitivity of MLC phosphorylation possibly by activating MLC phosphatase; and 4) dissociation of contraction from MLC phosphorylation. Difference between the effects of cyclic AMP and cyclic GMP are that 1) cyclic GMP augments Ca^{2+} extrusion by activating membrane Ca^{2+} pump and 2) cyclic GMP does not increase but decreases the noncontractile Ca^{2+} .

It should be emphasized that although the relaxant effect of nitro-vasodilators is mediated mainly by G kinase (e.g., see Nakazawa and Imai (1994)), a part of the effect is not (Salomone et al., 1995). This remaining part may be mediated by the direct effect of nitric oxide released from nitro-vasodilators on various functional proteins (see section IV.E.).

4. C kinase. a. ISOFORMS OF C KINASE IN SMOOTH MUSCLE. There are several isoforms of C kinase (see Nishizuka, 1995; Singer, 1996) and smooth muscle cells have α -, δ -, ϵ -, and ζ -isoforms (Schworer and Singer, 1991; Inoguchi et al., 1992; Khalil et al., 1992; Assender et al., 1994; Ali et al., 1994; Dixon et al., 1994; Khalil and Morgan, 1993; Ohanian et al., 1996). In freshly isolated vascular smooth muscle cells loaded with fura-2, Khalil et al. (1994) reported that increasing $[Ca^{2+}]_i$ caused translocation of α -isoform of C kinase and suggested that the $[Ca^{2+}]_i$ threshold of translocation of α -isoform in situ is less than that reported in most in vitro assays and is consistent with an effect of agonist-induced generation of other second-messengers that cause cooperative interactions leading to translocation. Contractions induced by phorbol esters may be mediated by α - and δ -isoforms (Ohanian et al., 1996), whereas phorbol ester-induced contractions induced in the absence of external Ca^{2+} may be mediated by ϵ - and ζ -isoforms (Khalil et al., 1992).

b. **INHIBITORS OF C KINASE.** Shimamoto et al. (1993) examined the effects of the putative C kinase inhibitors, calphostin C, H-7, and staurosporine, on aortic muscle contractions induced by high K^+ , phenylephrine, TPA, and phorbol 12,13-dibutyrate (PDBu). Calphostin C non-competitively inhibited contractions induced by TPA and PDBu. However, calphostin C had no effect on high K^+ -induced contractions but partially decreased the phenylephrine-induced contractions. H-7 had little effect on TPA-induced contractions but significantly inhibited contractile responses to phenylephrine and high K^+ . Staurosporine inhibited contractile responses to high K^+ , phenylephrine, and TPA. Thus, staurosporine and H-7, which are known to act on the catalytic domain of C kinase carrying a high degree of sequence homology with other protein kinases, seem to be relatively nonselective for C kinase. On the other hand, calphostin C acting on the regulatory domain of C kinase, which is distinct from other protein kinases, may serve as a relatively more selective C kinase inhibitor.

Himpens et al. (1993) showed that staurosporine increased $[Ca^{2+}]_i$ by releasing Ca^{2+} from perinuclear SR in DDT1MF-2 smooth muscle cells by a mechanism independent of inhibition of C kinase. Kageyama et al. (1991) reported that, although staurosporine is a relatively specific inhibitor of C kinase in intact arteries at lower concentrations, it may have actions unrelated to its inhibitory effect on C kinase at high concentrations which include the inhibition of Ca^{2+} influx through the voltage-dependent Ca^{2+} channel. In rabbit aorta, Asano et al. (1995a) showed that staurosporine inhibited the high K^+ -induced increase in $[Ca^{2+}]_i$. It has been shown that staurosporine also inhibits tyrosine kinases (Yamashita et al., 1991; Augustine et al., 1991).

c. **CONTRACTILE EFFECTS MEDIATED BY C KINASE.** Activation of C kinase has a diversity of effects on smooth muscle $[Ca^{2+}]_i$, MLC phosphorylation, and contraction. In A7r5 smooth muscle cell suspensions (Nakajima et al., 1993), 12-deoxyphorbol 13-isobutyrate (DPB) and PDBu caused elevation of $[Ca^{2+}]_i$ in localized peripheral regions, followed by expansion of this elevated $[Ca^{2+}]_i$ throughout the cytoplasm and contraction. In the absence of external Ca^{2+} , DPB induced contraction without changing $[Ca^{2+}]_i$. The increase in $[Ca^{2+}]_i$ was eliminated by staurosporine. In intact rabbit inferior vena cava (Nishimura et al., 1990), TPA caused a gradual increase in tension without changes in $[Ca^{2+}]_i$. In intact porcine coronary arteries (Mori et al., 1990b), PDBu produced a slowly developing and sustained contraction with only a small and transient increase in $[Ca^{2+}]_i$. Sato et al. (1992) examined tissue differences in the responses to phorbol esters. DPB induced a sustained contraction in isolated rat aorta, carotid artery and tail artery and rabbit aorta and mesenteric artery. However, DPB increased $[Ca^{2+}]_i$ only in rat aorta and carotid artery. Similar results were obtained with PDBu, although the inactive phorbol ester, 4- α -phorbol 12,13-

dibutyrate, was ineffective. DPB induced neither an increase in $[Ca^{2+}]_i$ nor a contraction in rabbit ear artery (Sato et al., 1992) and in rat anococcygeus muscle (Kaneda et al., 1995; Shimizu et al., 1995). In rat aorta, DPB-induced contraction was followed by an increase in MLC phosphorylation. Both contraction and MLC phosphorylation stimulated by DPB were greater than those due to high K^+ for a given increase in $[Ca^{2+}]_i$. Verapamil decreased the DPB-induced increments in $[Ca^{2+}]_i$ and MLC phosphorylation to their respective resting levels, although contraction was inhibited only slightly. In the absence of external Ca^{2+} , DPB induced a sustained contraction without increasing $[Ca^{2+}]_i$ or MLC phosphorylation. This contraction was followed by an increase in stiffness and force recovery after a shortening step. From these results, Sato et al. (1992) suggested that the contraction induced by DPB in rat aorta is due to an increase in $[Ca^{2+}]_i$ followed by MLC phosphorylation and Ca^{2+} sensitization of MLC phosphorylation. In the presence of verapamil or in the absence of external Ca^{2+} , DPB may increase cross-bridge cycling by activating an unknown mechanism that is not dependent on an increase in MLC phosphorylation.

Jiang and Morgan (1987) measured $[Ca^{2+}]_i$ with aequorin and found that, in ferret aorta, 12-deoxyphorbol 13-isobutyrate 20-acetate (DPBA) induced contractions without significantly increasing $[Ca^{2+}]_i$. Removal of external Ca^{2+} had no effect on DPBA-induced contraction. In rat aorta (Jiang and Morgan, 1987), both TPA and DPBA induced contractions without increasing $[Ca^{2+}]_i$. However, Ca^{2+} -free solution or the Ca^{2+} channel blocker methoxyverapamil inhibited the contraction induced by either phorbol ester accompanied by a decrease in $[Ca^{2+}]_i$. In ferret aortic smooth muscle (Ruzycky and Morgan, 1989; Jiang and Morgan, 1989), DPBA produced contractions accompanied by no detectable increases in aequorin luminescence or MLC phosphorylation. DPBA significantly shifted the control $[Ca^{2+}]_i$ -force relationship to lower $[Ca^{2+}]_i$ with an increase in the magnitude of maximal generated force. In aorta maximally precontracted by K^+ depolarization, DPBA increased force in the absence of further increases in $[Ca^{2+}]_i$. The relatively specific C kinase antagonist H-7 (Hidaka et al., 1984; Hidaka and Kobayashi, 1992) caused a significant decrease in intrinsic myogenic tone in the absence of a decrease in $[Ca^{2+}]_i$.

In swine carotid artery, Rembold and Murphy (1988a) showed that the relationships among $[Ca^{2+}]_i$, MLC phosphorylation, and steady-state stress induced by low-dose PDBu were similar to those observed with contractile agonists. However, prolonged exposure to high-concentrations of PDBu elicited high stress with elevated phosphorylation that was not associated with elevations in aequorin-estimated $[Ca^{2+}]_i$. They suggest that PDBu can increase $[Ca^{2+}]_i$, and that the resulting increase in MLC phosphorylation quantitatively explains the contraction. On the contribution of C kinase to agonist-

induced contraction, Rembold and Weaver (1990) showed that, in swine carotid smooth muscle, histamine and endothelin-1 induced the sustained and significant increases in $[Ca^{2+}]_i$, MLC phosphorylation, and contraction. Neither stimuli, however, induced significant increases in diacylglycerol mass. Relaxation of histamine-stimulated tissues was induced by removal of histamine or removal of extracellular Ca^{2+} in the continued presence of histamine. The rate of decline of both $[Ca^{2+}]_i$ and force was similar in both protocols, suggesting that removal of Ca^{2+} (without removing the stimulus) was equivalent to removal of the stimulus. These data suggest that $[Ca^{2+}]_i$ is the primary regulator of sustained swine arterial smooth muscle contraction, whereas diacylglycerol has, at most, only a minor role.

These results suggest that activation of C kinase opens the L-type Ca^{2+} channel and induces contraction in some types of smooth muscle. An increase in $[Ca^{2+}]_i$ is necessary for contraction in some types of smooth muscle whereas a $[Ca^{2+}]_i$ -independent contractile mechanism may be activated in other types of smooth muscle.

d. INHIBITORY EFFECTS MEDIATED BY C KINASE. In some types of smooth muscle, activation of C kinase inhibits the agonist-induced increases in $[Ca^{2+}]_i$. In primary cultures of airway smooth muscle cells, stimulation with histamine resulted in a transient rise in $[Ca^{2+}]_i$ and TPA blocked the release of Ca^{2+} by histamine (Kotlikoff et al., 1987). In cultured vas deferens smooth muscle DDT1MF-2 cells (Mitsubishi and Payan, 1988), TPA induced down-regulation of the H_1 receptor and inhibited the histamine-induced increases in $[Ca^{2+}]_i$. Also, in DDT1MF-2 cells (Dickenson and Hill, 1993), histamine and ATP stimulated both the release of Ca^{2+} from the SR and Ca^{2+} influx across the plasma membrane. PDBu attenuated the effects of histamine and ATP. The selective C kinase inhibitor, Ro 31-8220, reversed the inhibitory effect of PDBu. However, homologous and heterologous desensitization of histamine and ATP was not inhibited by Ro 31-8220, suggesting that although C kinase activation can attenuate the Ca^{2+} responses mediated by the histamine H_1 -receptor and the ATP receptor, C kinase-independent mechanisms appear to be involved in the homologous and heterologous desensitization of the histamine H_1 receptor and the ATP receptor.

In intact human airway smooth muscle cells (Marmy and Durand, 1995), activation of C kinase with TPA decreased and inhibition of C kinase with staurosporine increased the production of IP_3 in unstimulated and in histamine-stimulated cells. Yang et al. (1994D) reported that treatment of cultured canine tracheal smooth muscle cells with TPA for 30 min blocked the carbachol-stimulated formation of IP_3 and the mobilization of Ca^{2+} . The inhibitory effect of TPA was reversed by staurosporine. After down-regulation of C kinase by treatment of the cells with TPA for 24 h, the cells still responded to carbachol-induced IP_3 accumulation and

Ca^{2+} mobilization. The $[Ca^{2+}]_i$ response elicited by aluminum fluoride was inhibited by TPA treatment. These results indicate that GTP-binding protein(s) can be directly activated by aluminum fluoride and that C kinase exerts a negative feedback control on phospholipase C.

In the intestinal smooth muscle of guinea pig taenia coli, activation of C kinase has both stimulatory and inhibitory effects (Mitsui and Karaki, 1993). DPB did not change $[Ca^{2+}]_i$ and tension in resting muscle. In high K^+ -stimulated muscle, DPB transiently augmented the contraction and decreased $[Ca^{2+}]_i$. This effect was not observed when C kinase was down-regulated. In the presence of carbachol, DPB decreased $[Ca^{2+}]_i$ and transiently increased muscle tension. In muscle strips permeabilized with bacterial α -toxin, DPB shifted the Ca^{2+} -tension relationship to the lower Ca^{2+} levels. H-7 inhibited the effect of DPB. These results suggest that activation of C kinase has dual effects; augmentation of contractions by increasing the Ca^{2+} sensitivity of the contractile elements, and inhibition of contractions by decreasing $[Ca^{2+}]_i$.

In rat uterus (Kim et al., 1996B), DPB inhibited the contraction induced by high K^+ , ionomycin, oxytocin and thapsigargin. DPB also inhibited the increase in $[Ca^{2+}]_i$ elicited by these stimulants. However, DPB did not change Ca^{2+} sensitivity in intact and in permeabilized uterus. These results suggest that DPB decreased $[Ca^{2+}]_i$ by activating Ca^{2+} extrusion. The inhibitory effect of DPB was stronger in the pregnant uterus than in non-pregnant uterus.

5. *Tyrosine kinase*. Tyrosine kinases are functionally classified into three groups; tyrosine kinases associated with cell surface receptors (group 1), the focal adhesion kinase (group 2) and nucleus tyrosine kinases (group 3) (see Wang and McMurter, 1994). Smooth muscle contraction may be modified by the receptor tyrosine kinases (group 1A) or receptor-coupled tyrosine kinases (group 1B). Tyrosine kinase inhibitors have been reviewed by Levitzki and Gazit (1995).

In guinea pig gastric longitudinal muscle, Yang et al. (1992, 1993) found that the tyrosine kinase inhibitors, genistein and tyrphostin, inhibited the contractions elicited by epidermal growth factor-urogastrone, transforming growth factor- α and angiotensin II without changing the carbachol-mediated and bradykinin-mediated contractions. Di Salvo et al. (1993b) found that geldanamycin, tyrphostin and genistein markedly and reversibly inhibited contractions elicited by carbachol or norepinephrine in three different types of smooth muscles. In contrast, only slight inhibition occurred in contractions elicited by high K^+ . Moreover, tyrphostin did not inhibit Ca^{2+} -induced contraction in preparations permeabilized with β -escin. In guinea pig taenia coli, Di Salvo et al. (1993a) also showed that an inhibitor of protein tyrosine phosphatase, vanadate (Wong and Goldberg, 1983), elicited contractions and enhanced protein tyrosine phosphorylation, both of which effects were inhibited by

genistein. Vanadate also induced contraction and an increase in MLC phosphorylation without increasing $[Ca^{2+}]_i$ in rat uterus (Fukuzaki et al., 1992). Vanadate induced contractions in various types of smooth muscle (Ueda et al., 1984, 1985; Shimada et al., 1986). In rat uterus, however, contractions elicited by orthovanadate were not inhibited by genistein (Gokita et al., 1994). In rat aorta (Sauro and Thomas, 1993), platelet-derived growth factor (PDGF), an activator of tyrosine kinase, elicited contractions which were inhibited by tyrphostin. However, tyrphostin had no significant antagonistic effect on contractions induced by high K^+ , phenylephrine or PDBu. In rabbit ear arteries (Hughes, 1995), a selective inhibitor of tyrosine kinases, bistyrphostin, inhibited PDGF-induced contraction but had no effect on norepinephrine- or high K^+ -induced tone. In rat carotid artery and aorta (Watts et al., 1996), serotonin-induced contraction and tyrosine phosphorylation were inhibited by genistein. In rat aorta, phenylephrine-induced contraction (Filipeanu et al., 1995) and norepinephrine-induced contraction (Abebe and Agrawal, 1995) were inhibited by genistein. In rat aorta (Sauro et al., 1996), angiotensin II elicited contraction and tyrosine phosphorylation both of which were inhibited by tyrphostin.

The effects of tyrosine kinase inhibitors on contractions in smooth muscle are summarized in table 1. It is shown that tyrosine kinase inhibitors inhibit contractions induced by receptor agonists although inconsistent results are reported on norepinephrine and carbachol and no effect was reported on bradykinin. In contrast, contractions induced by high K^+ , caffeine, and PDBu are insensitive to these inhibitors. Although tyrosine kinase inhibitors may have nonselective inhibitory effects (e.g., see Smirnov and Aaronson (1995)), these results may suggest that tyrosine kinases participate in regulation of the signal transduction that is associated with the receptor-mediated contractions of smooth muscle.

Steusloff et al. (1995) examined the effects of genistein on potential coupling between tyrosine phosphorylation and Ca^{2+} sensitivity in permeabilized ileal smooth muscle. Results show that genistein reversibly inhibited both contractions induced in permeabilized muscle with Ca^{2+} in the presence of GTP and the receptor-coupled activation of Ca^{2+} sensitization with carbachol and GTP. Activation of permeabilized preparations in the presence of GTP promoted tyrosine phosphorylation of several substrates, an action of which was also inhibited by genistein. However, relatively high levels of MLC

TABLE 1
Effects of tyrosine kinase inhibitors on $[Ca^{2+}]_i$ and contraction in smooth muscle

Stimulants	Tyrosine kinase inhibitor			Smooth muscle	Reference
	Genistein	Tyrphostin	Others		
PDGF		+		Rat aorta	Sauro and Thomas, 1993
		+		Rabbit ear artery	Hughes, 1995
TGF α	+	+		Guinea pig gastric muscle	Yang et al., 1993
EGF	+	+		Guinea pig gastric muscle	Yang et al., 1992
Angiotensin II	+	+		Guinea pig gastric muscle	Yang et al., 1992
		+		Rat aorta	Sauro and Thomas, 1993
Endothelin-1	(+)		MD (+)	Porcine coronary artery	Liu and Sturek, 1996
Serotonin	+	+		Rat carotid artery	Watts et al., 1996
Phenylephrine	+			Rat aorta	Filipeanu et al., 1995
			GL+	Canine carotid artery	Di Salvo et al., 1993b
Norepinephrine	+	+	GL+	Rat mesenteric artery	Di Salvo et al., 1993b
	+	+		Rat aorta	Abebe and Agrawal, 1995
		-(-)		Rat carotid artery	Watts et al., 1996
Carbachol	-	-		Guinea pig gastric muscle	Yang et al., 1992; 1993
		+	GL+	Guinea pig taenia coli	Di Salvo et al., 1993b
Vasopressin	(+)	(-)	LV(\pm)	A7r5 cells	Kaplan and Di Salvo, 1996
Bradykinin	-	-		Guinea pig gastric muscle	Yang et al., 1992
Vanadate	+			Guinea pig taenia coli	Di Salvo et al., 1993a
	-			Rat uterus	Gokita et al., 1994
KCl	\pm			Rat aorta	Filipeanu et al., 1995
	-	-		Rat aorta	Abebe and Agrawal, 1995
		\pm		Rat carotid artery	Watts et al., 1996
		-(-)		Rabbit ear artery	Hughes, 1995
	(\pm)		MD(-)	Porcine coronary artery	Liu and Sturek, 1996
		-	GL-	Guinea pig taenia coli	Di Salvo et al., 1993b
Caffeine	(-)			Porcine coronary artery	Liu and Sturek, 1996
PDBu	-	-		Rat aorta	Abebe and Agrawal, 1995
	-	-		Rat carotid artery	Watts et al., 1996

+ and (+): Inhibition of contraction and $[Ca^{2+}]_i$, respectively.

\pm and (\pm): Weak inhibition of contraction and $[Ca^{2+}]_i$, respectively.

- and (-): No effect on contraction and $[Ca^{2+}]_i$, respectively.

MD: methyl-2,5-dihydroxycinnamate; GL, Geldanamycin; LV, Lavendustin.

phosphorylation persisted during genistein-induced inhibition of Ca^{2+} sensitivity. In contrast, genistein had no effect on Ca^{2+} -activated contraction in Triton X-100-permeabilized preparations, suggesting that genistein does not directly inhibit actin-myosin interaction and that its target(s) may be a cytosolic or membrane-bound regulatory protein(s) that is leaked out from the preparations during Triton X-100 treatment. In rat aorta (Abebe and Agrawal, 1995), genistein attenuated the contraction evoked by the direct activator of GTP-binding protein, sodium fluoride, suggesting the involvement of tyrosine kinases in responses associated with GTP-binding protein activation (Hollenberg, 1994a, b). Inhibition of tyrosine kinase by genistein, tyrphostin, or methyl 2,5-dihydroxycinnamate inhibited the initial transient $[\text{Ca}^{2+}]_i$ response to endothelin-1, norepinephrine, phenylephrine, or serotonin without changing IP_3 -induced Ca^{2+} release (Semenchuk and Di Salvo, 1995; Abebe and Agrawal, 1995; Liu and Sturek, 1996). Furthermore, Ca^{2+} influx elicited by arginine-vasopressin in A7r5 cells was inhibited by genistein (Kaplan and Di Salvo, 1996)(table 1). These results suggest that tyrosine phosphorylation of one or more substrates, including ras GAP, may be coupled to mechanisms which regulate Ca^{2+} influx, Ca^{2+} release and Ca^{2+} sensitivity (Di Salvo et al., 1994, 1996; Semenchuk and Di Salvo, 1995).

Gould et al. (1995) reported that, in swine carotid media, genistein attenuated the histamine-induced increases in $[\text{Ca}^{2+}]_i$, MLC phosphorylation, and stress, and that the genistein-dependent decrease in $[\text{Ca}^{2+}]_i$ quantitatively accounted for the decrease in MLC phosphorylation and stress. There was no measurable change in Ca^{2+} sensitivity. From these data, they suggested that tyrosine kinase(s) may influence force development in the intact swine carotid media by altering $[\text{Ca}^{2+}]_i$ rather than by modulating the Ca^{2+} sensitivity of MLC phosphorylation. Furthermore, Touyz and Schiffrin (1996) found that, in rat mesenteric artery cells, the increase in $[\text{Ca}^{2+}]_i$ due to angiotensin II was inhibited by stimulation of tyrosine kinase pathway by insulin, insulin-like growth factor-1 and PDGF-BB. In the presence of tyrphostin and genistein, the angiotensin II-induced increase in $[\text{Ca}^{2+}]_i$ remained persistently elevated and failed to return to basal level. There may be tissue differences in the nature of the contribution of tyrosine kinase to smooth muscle contraction.

In the gastrointestinal tract of the mouse, pacemaker cells are expressing the *Kit* gene, which is a proto-oncogene encoding a receptor tyrosine kinase of the PDGF/colony-stimulating factor-1 receptor family. Injection of a neutralizing antibody for the proto-oncogene product, the Kit protein, into mice during the first few days after birth greatly reduced the number of Kit-expressing cells in intestinal segments, and this was accompanied by impairment of development of normal rhythmic mechanical activity in the mouse intestine (Maeda et al., 1992). This result suggests that tyrosine kinase is playing an

important role on generation of electrical rhythmicity in the gastrointestinal tract (Nishi et al., 1996; Sanders, 1996).

Kaplan and Di Salvo (1996) reported that, in A7r5 cells, the increase in $[\text{Ca}^{2+}]_i$ elicited by arginine-vasopressin was inhibited strongly by genistein, weakly by lavendustin, and not affected by tyrphostin. Furthermore, the increase in $[\text{Ca}^{2+}]_i$ and the tyrosine phosphorylation elicited by arginine-vasopressin and vanadate were inhibited by genistein although lavendustin and tyrphostin enhanced phosphorylation. These results may suggest the presence of tyrosine kinase subtypes and selective inhibition of these subtypes by these inhibitors.

6. Phosphatases. Okadaic acid, isolated from marine sponges of the genus *Halichondria* (Tachibana et al., 1981), is the first exogenous inhibitor of the serine/threonine protein phosphatase. Okadaic acid has a relatively high specificity for type 2A phosphatase rather than for type 1 phosphatase, with weak inhibitory effect on type 2B and no effect on type 2C in skeletal muscle protein phosphatases (Bialojan and Takai, 1988). In contrast, calyculin A, isolated from marine sponge genus *Discodermia* (Kato et al., 1986), nonselectively inhibits type 1 and type 2A phosphatase (Ishihara et al., 1989a). Microcystin-LR, isolated from the cyanobacterial genera *Microcystis*, has a similar inhibitory action on phosphatases with okadaic acid (Eriksson et al., 1990a, b; MacKintosh et al., 1990). Tautomycin, isolated from the bacterium *Streptomyces verticillatus*, in contrast, is a nonselective inhibitor of type 1 and type 2A protein phosphatases in a manner similar to calyculin A (MacKintosh and Klumpp, 1990; Hori et al., 1991).

In vascular and intestinal smooth muscles, Shibata et al. (1982) demonstrated that okadaic acid caused a sustained contraction. In rat aorta, contractions induced by okadaic acid and calyculin A were accompanied by an increase in $[\text{Ca}^{2+}]_i$ (Ozaki and Karaki, 1989; Ishihara et al., 1989b). The increase in $[\text{Ca}^{2+}]_i$, but not contraction, was abolished by verapamil. This result is consistent with the finding that calyculin A increased the voltage-dependent inward current in smooth muscle cells isolated from guinea pig taenia coli (Usuki et al., 1989, 1991; Yabu et al., 1990a, b). The action of calyculin A to facilitate Ca^{2+} current was inhibited by an inhibitor of C kinase, H-7, suggesting that calyculin A activates the Ca^{2+} channel through C kinase-dependent phosphorylation.

In airway smooth muscle cells, both okadaic acid and isoproterenol enhanced the open state probability of the Ca^{2+} -activated K^+ channel (Kume et al., 1989). Similar results were obtained in canine proximal colon (Carl et al., 1991), guinea pig taenia coli (Obara and Yabu, 1993) and rabbit gastric antrum (Lee et al., 1994) using okadaic acid and calyculin A. In vascular smooth muscle cells, okadaic acid, nitric oxide and cyclic GMP increased whole-cell K^+ current by activation of the Ca^{2+} -acti-

vated K^+ channel (Archer et al., 1994; Lincoln et al., 1994). These results suggest that protein phosphorylation induced by A kinase and G kinase is mediating these effects. In canine gastric muscle (Ward et al., 1991), okadaic acid and calyculin A inhibited the amplitude and duration of gastric slow waves. Both of these phosphatase inhibitors reduced the amplitude of the peak and the sustained components of the inward Ca^{2+} current, suggesting that phosphorylation of Ca^{2+} channels of gastrointestinal smooth muscles may inhibit Ca^{2+} currents. Tautomycin also inhibited Ca^{2+} channel activity due to a reduction of channel availability in smooth muscle cells isolated from human umbilical vein (Groschner et al., 1995).

Okadaic acid induced sustained contraction even in the absence of external Ca^{2+} (Shibata et al., 1982). The increases in $[Ca^{2+}]_i$ are not necessary for contraction induced by calyculin A in rat aorta (Ozaki and Karaki, 1989; Ishihara et al., 1989b; Obara et al., 1989). Okadaic acid also elicited a contraction in permeabilized smooth muscle strips (Ozaki et al., 1987b) and phosphorylated MLC (Ozaki et al., 1987a) in the absence of Ca^{2+} . In canine gastric antrum, calyculin A induced a sustained contraction with an increase in MLC phosphorylation, although there was no increase in $[Ca^{2+}]_i$ (Ozaki et al., 1991a). In permeabilized smooth muscle strips of the rabbit mesenteric artery (Suzuki and Itoh, 1993), calyculin A produced a contraction and MLC phosphorylation in Ca^{2+} -free solution. This Ca^{2+} -independent contraction may be caused by inhibition of phosphatase activity. This will uncover a basal level of MLC kinase activity which is usually suppressed by MLC phosphatase activity (Takai et al., 1987; Ozaki and Karaki, 1989).

Okadaic acid inhibited contractions induced by high K^+ with only a small decrease in $[Ca^{2+}]_i$ in rabbit aorta (Karaki et al., 1979). Also, in swine coronary artery and dog basilar artery (Ashizawa et al., 1989), okadaic acid inhibited the high K^+ -induced contraction without decreasing $[Ca^{2+}]_i$. In contrast, okadaic acid inhibited thrombin-induced platelet aggregation accompanied by a decrease in $[Ca^{2+}]_i$ (Karaki et al., 1989). In guinea pig vas deferens, okadaic acid inhibited the increments in $[Ca^{2+}]_i$ and contraction induced by norepinephrine whereas it inhibited high K^+ -induced contraction without decreasing $[Ca^{2+}]_i$ (Shibata et al., 1991). In bovine tracheal smooth muscle, okadaic acid inhibited the carbachol-induced increase in $[Ca^{2+}]_i$ and contraction (Tansley et al., 1990). In rat aorta, Abe and Karaki (1993) found that okadaic acid strongly augmented the relaxant effects of dibutyryl cyclic AMP and forskolin. These results suggest that okadaic acid may act by inhibiting protein phosphatases, resulting in an indirect activation of A kinase-dependent protein phosphorylation (Karaki et al., 1989).

Calyculin A caused a change in the morphology in 3T3 fibroblast cell (Chartier et al., 1991). The change of cell

shape was independent of the external Ca^{2+} and accompanied with phosphorylation of vimentin with disappearance of stress fibers, intermediate filaments and microtubules. Calyculin A caused a similar shape change in cultured A10 smooth muscle cells (Hosoya et al., 1993). Vinculin, one of the components of focal contacts, which was localized at the periphery of control cell, was translocated toward the inside of the cell along stress fibers by calyculin A. These results suggest that the changes in cytoskeletal structure will be controlled by concerted actions of a kinase-phosphatase couple.

B. Agents That Change Sarcoplasmic Reticulum Function

1. Caffeine. Caffeine is widely used as a pharmacological tool for studying excitation-contraction coupling in muscle physiology and pharmacology. The primary site of action has been assumed to be located on the SR. In the vascular smooth muscle of rabbit aorta (Karaki, 1987), caffeine induced a transient contraction which is attributable to the release of Ca^{2+} from internal stores. The caffeine-induced contraction was inhibited by external Mg^{2+} and by procaine and it was potentiated by low temperature. These results are compatible with the general characteristics of CICR, suggesting that the CICR plays an important role in the contraction induced by caffeine (see Karaki and Weiss, 1988).

Caffeine also increases Ca^{2+} influx in some smooth muscles. In rat aorta (Sato et al., 1988b), caffeine induced a transient increase followed by a sustained increase in $[Ca^{2+}]_i$. In Ca^{2+} -free solution, caffeine induced only a transient increase in $[Ca^{2+}]_i$, suggesting that the sustained increase in $[Ca^{2+}]_i$ is due to Ca^{2+} influx. In toad gastric smooth muscle cells (Guerrero et al., 1994a, b), caffeine caused both an increase in $[Ca^{2+}]_i$ and activation of the nonselective cation channel. The channel activated by caffeine appeared to be permeable to Ca^{2+} . Caffeine activated the nonselective cation channel even when $[Ca^{2+}]_i$ was clamped to less than 10 nM when the patch pipette contained 10 mM 1,2-bis(2-aminophenoxy)ethane-*N,N,N',N'*-tetraacetic acid (BAPTA), suggesting that caffeine directly activates the channel and that it is not being activated by the increase in $[Ca^{2+}]_i$ that occurs when caffeine is applied to the cell.

In rat aorta, caffeine-induced a large and transient increase in $[Ca^{2+}]_i$ followed by a smaller contraction (Sato et al., 1988b; Watanabe et al., 1992) and a smaller MLC phosphorylation (Harada et al., 1996) than expected from the increased $[Ca^{2+}]_i$. During the sustained increase in $[Ca^{2+}]_i$, muscle tension decreased to a level below a resting tone (Sato et al., 1988b). It has been shown that, besides the contractile effect, caffeine has an inhibitory effect in various smooth muscles (Ito and Kuriyama, 1971; Sunano and Miyazaki, 1973; Nasu et al., 1975; Poch and Umfaher, 1976; Casteels et al., 1977; Leijten and Van Breemen, 1984; Ahn et al., 1988). During the sustained increase in $[Ca^{2+}]_i$ induced by

norepinephrine or high K^+ , addition of caffeine partially decreased $[Ca^{2+}]_i$ and completely inhibited contractions in rat aorta (Sato et al., 1988b) and in swine coronary artery (Van Der Bent and Beny, 1991). These results suggest that caffeine directly inhibits the contractile elements.

Caffeine inhibits cyclic AMP phosphodiesterase and increases cyclic AMP in smooth muscle (Butcher and Sutherland, 1962; Inatomi et al., 1975; Poch and Umfahrer, 1976; Polson et al., 1978; Fredholm et al., 1979). Therefore, caffeine-induced inhibition of muscle contraction has been assumed to be at least partly mediated by cyclic AMP-dependent mechanisms. In chicken gizzard smooth muscle (Ozaki et al., 1990a), caffeine inhibited the high K^+ -induced contraction. Although caffeine and forskolin increased tissue cyclic AMP levels, caffeine inhibited the high K^+ -induced contraction more strongly than did forskolin at a given cyclic AMP level. In Triton X-100-permeabilized muscle, caffeine inhibited both contractions induced by Ca^{2+} and phosphorylation of MLC. Caffeine also inhibited the Ca^{2+} -independent contraction elicited by ATP in thiophosphorylated permeabilized muscle. These results indicate that caffeine inhibits smooth muscle contraction by direct inhibition of MLC kinase and the actin-myosin interaction.

In swine carotid artery, Rembold et al. (1995) reported that although caffeine increased $[Ca^{2+}]_i$, it elicited neither sustained increase in MLC phosphorylation nor contraction. Caffeine also increased cyclic AMP content although phosphorylation of MLC kinase did not seem to be responsible for the dissociation of contraction from increase in $[Ca^{2+}]_i$. Comparing the Ca^{2+} signals obtained with aequorin and fura-2, they suggested that caffeine may localize increases in $[Ca^{2+}]_i$ to a region distinct from the contractile apparatus.

In permeabilized A7r5 cells (Missiaen et al., 1994b), the IP_3 -induced Ca^{2+} release was inhibited by caffeine and theophylline. The inhibition occurred similarly in the absence or presence of extravesicular Ca^{2+} and was not associated with a decrease in IP_3 binding to the receptor. ATP prevented the inhibition, suggesting that caffeine may interact with an ATP binding site on the IP_3 receptor. Ozaki et al. (1988) demonstrated that the inhibition of MLC phosphorylation by caffeine was antagonized by raising the ATP concentration. Since caffeine and other xanthine derivatives contain an adenine ring in their structure, as does ATP, xanthines may compete with ATP at their binding sites.

In cultured myometrial cells (Martin et al., 1989) caffeine inhibited the Ca^{2+} current with an IC_{50} of 35 mM. The caffeine-induced inhibition was accompanied by inhibition of the binding of a Ca^{2+} channel blocker, isradipine, to myometrial membranes with a similar IC_{50} value. Hughes et al. (1990) also reported that, in single rabbit ear artery cells, caffeine caused a rapid and reversible blockade of Ba^{2+} current. The related compound, 3-isobutyl-1-methylxanthine, was a more potent

inhibitor of the Ba^{2+} current. The non-xanthine inhibitors of phosphodiesterase, rolipram, and M & B 22948, did not diminish the inward Ba^{2+} current. These data suggest that caffeine directly interacts with voltage-dependent Ca^{2+} channels to inhibit Ca^{2+} influx.

2. Ryanodine. Ryanodine is a neutral alkaloid extracted from *Ryania speciosa* and has been demonstrated to alter specifically Ca^{2+} movements across SR membranes in cardiac and skeletal muscles (Sutko et al., 1979, 1997; Sutko and Willerson, 1980). Ito et al. (1986) first demonstrated that ryanodine suppressed the phasic contractions in smooth muscle elicited by caffeine and norepinephrine in Ca^{2+} -free medium. This finding was confirmed in different smooth muscles using different stimulants; norepinephrine in rabbit aorta (Hwang and Van Breemen, 1987), caffeine and carbachol in canine tracheal muscle (Gerthoffer et al., 1988), caffeine and norepinephrine in rat aorta (Sato et al., 1988b; Hisayama et al., 1990), caffeine in guinea pig taenia coli (Hisayama and Takayanagi, 1988), norepinephrine in rabbit ear artery (Kanmura et al., 1988), caffeine in rat and guinea pig aorta (Ito et al., 1989), endothelin-1 in coronary arterial cells (Wagner-Mann and Sturek, 1991), acetylcholine and caffeine in porcine coronary artery (Katsuyama et al., 1991) and acetylcholine in canine colonic smooth muscle (Sato et al., 1994a). Ito et al. (1986) also reported that ryanodine prevented the stimulation of $^{45}Ca^{2+}$ efflux by norepinephrine and caffeine although it did not alter the high K^+ -induced contraction and accompanying increase in $^{45}Ca^{2+}$ influx. These data are consistent with the hypothesis that ryanodine inhibits SR Ca^{2+} release in vascular smooth muscle. Aoki and Ito (1988) further demonstrated that opening of the Ca^{2+} release channel enhanced the interaction of ryanodine with the channel and confirmed the previous finding (Sutko et al., 1985) that ryanodine irreversibly opens the Ca^{2+} channels in the SR.

Distribution of ryanodine-binding sites in subcellular fractions isolated from rat vas deferens paralleled that of NAD(P)H cytochrome *c* reductase activity, indicating an SR origin for the ryanodine binding sites (Bourreau et al., 1991). Zhang et al. (1993) reported that ryanodine binding was Ca^{2+} -dependent, with half-maximal binding occurring within the physiologically relevant $[Ca^{2+}]_i$. Agents known to inhibit (ruthenium red, Mg^{2+}) or enhance (caffeine) the CICR similarly inhibited or enhanced the binding of ryanodine.

The Ca^{2+} release channel of aortic SR was isolated from canine and porcine aortas using ryanodine-binding as a marker. Reconstituted into planar lipid bilayers, it formed a Ca^{2+} - and monovalent ion-conducting channel (Herrmann-Frank et al., 1991). This channel was activated by Ca^{2+} , modulated by ATP, Mg^{2+} , and caffeine, and inhibited by ruthenium red. Micromolar to millimolar concentrations of ryanodine induced a permanently closed state of the channels.

3. Inhibitors of sarcoplasmic reticulum calcium pump.

Three compounds have been identified to be selective inhibitors of the SR Ca^{2+} pump; thapsigargin isolated from the umberilliferous plant, a mycotoxin, cyclopiazonic acid, and 2,5-di-(*tert*-butyl)-1,4-benzohydroquinone. These inhibitors have been used to clarify the roles of SR Ca^{2+} pumps in the regulation of $[\text{Ca}^{2+}]_i$ in smooth muscle (see Goeger and Riley, 1989; Thastrup, 1990; Seidler et al., 1989; Ozaki et al., 1992c; Uyama et al., 1992; Luo et al., 1993; Darby et al., 1993; Kwan et al., 1994).

Although these compounds act on the SR Ca^{2+} pump, several lines of evidence demonstrated their nonselective actions. Uptake of $^{45}\text{Ca}^{2+}$ by Ca^{2+} stores of permeabilized A7r5 cells was inhibited by nanomolar concentrations of thapsigargin. Patch-clamp analysis showed that thapsigargin, at micromolar concentrations but not at nanomolar concentrations, inhibited the L-type Ca^{2+} channel current. Thapsigargin also inhibited the specific binding of a Ca^{2+} channel blocker, isradipine, in intact cells at micromolar concentrations. The equilibrium dissociation constant of isradipine was increased in the presence of thapsigargin as a result of an increase in the dissociation rate constant, indicating that the inhibitory effect of the antagonist cannot be attributed to a simple competitive interaction with the 1,4-dihydropyridine binding site (Buryi et al., 1995). These results indicate that thapsigargin inhibits the voltage-dependent Ca^{2+} current by a direct interaction with the L-type Ca^{2+} channels at higher concentrations.

In longitudinal muscle strips of the rat uterus (Kasai et al., 1994), oxytocin induced a transient increase in $[\text{Ca}^{2+}]_i$ and contraction in Ca^{2+} -free solution. Cyclopiazonic acid, at submicromolar concentrations, inhibited the Ca^{2+} release and contraction, but had no effect on oxytocin-induced rhythmic contractions. At a hundred times higher concentration, cyclopiazonic acid inhibited the rhythmic contractions. These results suggest that low concentrations of cyclopiazonic acid inhibit SR Ca^{2+} loading in intact tissue strips, and that the SR is not directly involved in uterine rhythmic contractions. It is also suggested that a high concentration of cyclopiazonic acid inhibits the mechanism responsible for generation of rhythmic contractions.

In addition to the effect on the SR Ca^{2+} pump, 2,5-di-(*tert*-butyl)-1,4-benzohydroquinone reduced the passive Ca^{2+} leak from internal stores in permeabilized A7r5 vascular smooth muscle cells (Missiaen et al., 1992). This nonspecific effect occurred at concentrations that are normally used to empty the stores in intact cells. Cyclopiazonic acid exerted a similar, although less pronounced effect, while thapsigargin did not affect the passive Ca^{2+} leak.

C. Stimulants

1. *Membrane depolarization.* Membrane depolarization opens the L-type Ca^{2+} channels, increases Ca^{2+}

influx, increases $[\text{Ca}^{2+}]_i$ and induces contraction. Thus, contraction induced by high K^+ is considered to be due to a relatively simple mechanism, an increase in $[\text{Ca}^{2+}]_i$ without changing other signal transduction systems including phosphatidylinositol turnover and Ca^{2+} sensitization.

The Ca^{2+} channel is activated also by maitotoxin, a potent marine toxin isolated from toxic tropical dinoflagellates and poisonous fishes, which induces contractions in different smooth muscle preparations (Takahashi et al., 1982; Ohizumi et al., 1983; Ohizumi and Yasumoto, 1983a, b). In a primary culture of aortic cells (Berta et al., 1986, 1988; Gusovsky et al., 1989), maitotoxin induced a very large increase in $[\text{Ca}^{2+}]_i$ concomitant with stimulation of inositolphosphate accumulation and loss of viability of the cells. These responses to maitotoxin were abolished in Ca^{2+} -free medium, and were mimicked by saponin. Calcium ionophores or high K^+ -induced membrane depolarization did not induce inositolphosphate formation. These results suggest that maitotoxin acts by altering membrane permeability, allowing a sustained Ca^{2+} influx which is able to activate inositolphosphate formation and which is lethal for the cells. In guinea pig taenia coli, maitotoxin induced a much smaller contraction than did high K^+ at a given $[\text{Ca}^{2+}]_i$ even at lower concentrations that did not damage the tissue (Ohizumi and Karaki, unpublished observations).

Another method to increase $[\text{Ca}^{2+}]_i$ is to use Ca^{2+} ionophores. Although ionomycin increased $[\text{Ca}^{2+}]_i$ and muscle tension, changes in contractile force were smaller than those induced by high K^+ at a given $[\text{Ca}^{2+}]_i$ in rat aorta (Sato et al., 1988a, b; Bruschi et al., 1988). In tracheal smooth muscle cells (Taylor and Stull, 1988), stimulation with carbachol or ionomycin resulted in a rapid increase in $[\text{Ca}^{2+}]_i$ and in the extent of MLC phosphorylation. Although the maximal increases in $[\text{Ca}^{2+}]_i$ were greater with ionomycin than with carbachol, there was a similar relationship between $[\text{Ca}^{2+}]_i$ and the extent of MLC phosphorylation in the carbachol- and ionomycin-stimulated cells. If similar relationships also exists in rat aorta, differences observed in the contractile effects of high K^+ and ionomycin may indicate that coupling between MLC phosphorylation and contraction is impaired in the presence of ionomycin. These results suggest that contractions induced by high K^+ are different from those induced by an opening of Ca^{2+} channel by maitotoxin or an increase in Ca^{2+} permeability by ionophore.

In single voltage-clamped coronary arterial smooth muscle cells of the guinea pig (Ganitkevich and Isenberg, 1993b, 1996b), acetylcholine increased $[\text{Ca}^{2+}]_i$. During the subsequent slow decay, $[\text{Ca}^{2+}]_i$ was transiently increased by depolarizing clamp steps and decreased during hyperpolarizing steps. Calcium transients in response to caffeine could not be modulated by voltage steps. The results suggest that modulation of

$[Ca^{2+}]_i$ by membrane potential involves IICR. Submaximum concentration of acetylcholine induced a $[Ca^{2+}]_i$ increase after a latency period and membrane depolarization from -50 mV to $+50$ mV reduced the latency period. Supramaximal acetylcholine induced $[Ca^{2+}]_i$ transients with a shorter latency, which was independent of membrane potential. When applied repetitively at -50 mV, acetylcholine induced $[Ca^{2+}]_i$ transients with a progressively reduced amplitude and slower rate of rise. Depolarization to $+50$ mV accelerated the rate of rise of the $[Ca^{2+}]_i$ transient without affecting the amplitude. These results suggest that membrane depolarization modulates the initiation but not amplitude of $[Ca^{2+}]_i$ transient by an increase in the rate of IP_3 accumulation elicited by activation of the muscarinic receptor.

Okada et al. (1992) and Yanagisawa and Okada (1994) reported that, in isolated canine coronary artery stimulated with 90 mM KCl, washout of the muscle with a solution containing 5 mM KCl and 2.5 mM $CaCl_2$ (5 K-2.5 Ca) or 90 mM KCl and 0 mM $CaCl_2$ (90 K-0 Ca) decreased $[Ca^{2+}]_i$ and induced relaxations. The rate of relaxation induced by 90 K-0 Ca was slower than that induced by 5 K-2.5 Ca with no difference in the rate of decrease in $[Ca^{2+}]_i$. A solution containing 30 mM KCl and 0 mM $CaCl_2$ had effects between those in 5 K-0 Ca and 90 K-0 Ca. They also showed that a K^+ channel opener, levcromakalim, hyperpolarized the membrane, reduced $[Ca^{2+}]_i$, and inhibited contraction induced by 30 mM KCl. The $[Ca^{2+}]_i$ -force relationships, determined either in the presence of levcromakalim or by decreasing extracellular K^+ concentrations, located to the right (higher $[Ca^{2+}]_i$) of the control curve initially determined by decreasing extracellular Ca^{2+} concentrations in 30 mM KCl. From these results, they concluded that high K^+ -induced membrane depolarization increased Ca^{2+} sensitivity whereas membrane hyperpolarization induced by levcromakalim decreased the Ca^{2+} sensitivity of contractile elements.

Comparing to the effects of activation of either receptor/GTP-binding protein or C kinase on Ca^{2+} sensitivity, effects of high K^+ are different. Inhibition of Ca^{2+} channels almost completely inhibited the increase in $[Ca^{2+}]_i$ induced by receptor agonists or phorbol esters. However, contractions induced by these Ca^{2+} sensitizers were only partially inhibited. These results suggest that, in the presence of these Ca^{2+} sensitizers, contractions can be elicited at a resting level of $[Ca^{2+}]_i$, and that Ca^{2+} channel blockers do not inhibit Ca^{2+} sensitization. In contrast, $[Ca^{2+}]_i$ -force relationship obtained by cumulative addition of KCl was not different from that obtained by cumulative addition of Ca^{2+} channel blocker in the presence of maximally effective concentration of KCl. This result suggests that the graded increase in both $[Ca^{2+}]_i$ and membrane depolarization induced the same magnitude of contractions to those elicited by a graded decrease in $[Ca^{2+}]_i$ in the presence of constant mem-

brane depolarization at a given $[Ca^{2+}]_i$. Furthermore, contractions induced by high K^+ were completely inhibited when $[Ca^{2+}]_i$ was decreased to a resting level by Ca^{2+} channel blockers (Yanagisawa et al., 1989; Kageyama et al., 1995), suggesting that high K^+ -depolarization can not induce contraction in the presence of resting level of $[Ca^{2+}]_i$.

The Ca^{2+} sensitizing effect of high K^+ explains the differences in contractile effects of high K^+ , ionophores and toxins. However, this possibility was suggested by comparing $[Ca^{2+}]_i$ detected by fura-2 and contractile force. Since high K^+ solution changes the water contents of smooth muscle cells (Suzuki et al., 1980, 1981; Karaki et al., 1983), it is necessary to examine if dissociation between $[Ca^{2+}]_i$ and contraction is due to high K^+ -induced change in Ca^{2+} distribution in such a manner that high K^+ increased the relative size of the contractile Ca^{2+} compartment compared to that of the noncontractile Ca^{2+} compartment. To more directly determine the changes in Ca^{2+} sensitivity, permeabilized smooth muscle preparations, in which Ca^{2+} concentration can be clamped at a constant level, are usually used. Unfortunately, however, it is not possible to examine the effects of membrane potential using a permeabilized smooth muscle preparation in which membrane electrophysiological functions have been lost.

2. Receptor agonists.

a. α -ADRENOCEPTOR AGONISTS. In rat aorta (Hisayama et al., 1990), stimulation of the α_1 -adrenoceptors by phenylephrine induced a transient contraction in Ca^{2+} -free solution and elicited a transient increase in $[Ca^{2+}]_i$ due to Ca^{2+} release. Phenylephrine-induced Ca^{2+} release was inhibited by heparin (Kobayashi et al., 1989). In ferret aorta, in contrast, phenylephrine elicited neither Ca^{2+} release nor contraction in Ca^{2+} -free solution (Jiang and Morgan, 1987). Also, in rat anococcygeus muscle (Shimizu et al., 1995), phenylephrine induced only a small increase in $[Ca^{2+}]_i$ and a small contraction in Ca^{2+} -free solution. In rat tail artery (Chen and Rembold, 1995), phenylephrine elicited Ca^{2+} release only at high concentrations.

In the presence of external Ca^{2+} , phenylephrine induced a sustained increase in $[Ca^{2+}]_i$ and a sustained contraction. In rat tail artery (Chen and Rembold, 1995), phenylephrine depolarized the membrane and increased Ca^{2+} influx. Low concentrations of phenylephrine also increased $[Ca^{2+}]_i$ independent of changes in membrane potential, potentially by the increases in Ca^{2+} influx. In rat anococcygeus muscle (Shimizu et al., 1995), verapamil inhibited the contraction and the increase in $[Ca^{2+}]_i$ elicited by phenylephrine.

In ferret portal vein (Morgan and Morgan, 1984b), phenylephrine produced a larger force than did high K^+ at a given $[Ca^{2+}]_i$. Similar results were obtained in guinea pig aorta (Jiang et al., 1994), swine carotid artery (Rembold, 1990) and ferret aorta (Jiang and Morgan, 1989). In permeabilized ferret aortic cells, phenyleph-

rine augmented the contraction induced by Ca^{2+} (Collins et al., 1992). The response of the cells to a constant concentration of phenylephrine in different Ca^{2+} buffers showed a lack of Ca^{2+} dependence between pCa 8.6 and 7.0. From these and other results, it was suggested that the phenylephrine-induced contraction that occurred in the permeabilized cells at constant $[\text{Ca}^{2+}]_i$ was the result of activation of a Ca^{2+} -independent isozyme of C kinase (Khalil et al., 1992). In contrast, phenylephrine did not change Ca^{2+} sensitivity in rat anococcygeus muscle (Shimizu et al., 1995).

In rabbit ear artery cells (Declerck et al., 1990), phenylephrine increased force development in K^+ -depolarized tissues, but reduced $[\text{Ca}^{2+}]_i$ by inhibiting the L-type Ca^{2+} channel. However, in the presence of verapamil, phenylephrine increased both force development and $[\text{Ca}^{2+}]_i$ by increasing Ca^{2+} influx through activation of a non-L-type Ca^{2+} entry pathway.

In rat aorta, norepinephrine increased $[\text{Ca}^{2+}]_i$ followed by contraction (Ozaki et al., 1987c; Bruschi et al., 1988). In Ca^{2+} -free solution, norepinephrine induced only a transient increase in $[\text{Ca}^{2+}]_i$ whereas it induced a transient contraction followed by a small sustained contraction (fig. 2). The second application of norepinephrine induced a small sustained contraction (10% of that obtained in the presence of Ca^{2+}) without increasing $[\text{Ca}^{2+}]_i$. These changes were not affected by verapamil (Sato et al., 1988a; Karaki et al., 1988a, 1991). In cultured porcine aortic smooth muscle cells (Erdbrugger et al., 1993), norepinephrine released Ca^{2+} and transiently increased $[\text{Ca}^{2+}]_i$ by activating the α_2 -adrenoceptors predominantly (if not exclusively). Pretreatment of cells with pertussis toxin abolished norepinephrine-stimulated $[\text{Ca}^{2+}]_i$ elevations (but not those stimulated by angiotensin II) suggesting involvement of a G_i -like GTP-binding protein.

In rat aorta (Sato et al., 1988a; Karaki et al., 1988a, 1991), verapamil inhibited the norepinephrine-induced sustained increase in $[\text{Ca}^{2+}]_i$. Verapamil decreased the norepinephrine-stimulated $[\text{Ca}^{2+}]_i$ more strongly than the accompanying contraction. In the presence of verapamil, norepinephrine induced a transient increase in $[\text{Ca}^{2+}]_i$, followed by a small sustained increase in $[\text{Ca}^{2+}]_i$ and a sustained contraction (fig. 2). In rat aorta (Sato et al., 1988a; Karaki et al., 1988a, 1991), the contraction induced by norepinephrine was greater than that induced by high K^+ at a given $[\text{Ca}^{2+}]_i$. In rat and rabbit mesenteric artery permeabilized by α -toxin (Nishimura et al., 1990), norepinephrine, TPA and $\text{GTP}_\gamma\text{S}$ augmented the contraction induced by Ca^{2+} . The response to norepinephrine was augmented by GTP and inhibited by guanosine-5'-*O*- β -thiodiphosphate ($\text{GDP}\beta\text{S}$), suggesting that the increase in Ca^{2+} sensitivity is mediated by a GTP-binding protein coupled with the α -adrenoceptor.

In rabbit aorta (Takayanagi and Onozuka, 1990), the α_1 -adrenergic partial agonists, tizanidine (Konno and Takayanagi, 1986), induced greater contraction at a

given $[\text{Ca}^{2+}]_i$ than α_1 -adrenergic full agonists, phenylephrine and norepinephrine. The intrinsic activities of the partial agonists obtained from tension measurements were greater than those obtained from changes observed in $[\text{Ca}^{2+}]_i$. These results suggest that the partial agonists increase Ca^{2+} sensitivity of the contractile elements more strongly than the full agonists.

In rat portal vein (Pacaud et al., 1992, 1993; Pacaud and Loirand, 1995), norepinephrine elicited a transient increase in $[\text{Ca}^{2+}]_i$ by releasing Ca^{2+} followed by a sustained increase. The sustained increase in $[\text{Ca}^{2+}]_i$ is due to Ca^{2+} entry through both the L-type Ca^{2+} channel and CRAC. Also, in rat portal vein in which the α_1 -adrenoceptors were inhibited by prazosin (Lepretre and Mironneau, 1994), activation of the α_2 -adrenoceptors by a selective α_{2A} -adrenoceptor agonist, oxymetazoline, an α_2 -adrenoceptor agonist, clonidine, or a nonselective α -adrenoceptor agonist, norepinephrine, caused a slow and sustained increase in $[\text{Ca}^{2+}]_i$ which was inhibited by the α_2 -adrenoceptor antagonist, rauwolscine. The increase in $[\text{Ca}^{2+}]_i$ did not occur in Ca^{2+} -free solution or in the presence of the Ca^{2+} channel blocker, oxodipine. Whole-cell patch-clamp experiments showed that the α_{2A} -adrenoceptor activation promoted Ca^{2+} influx through the L-type channels. The α_{2A} -adrenoceptor-mediated Ca^{2+} influx was unchanged after complete release of the stored Ca^{2+} . In addition, no accumulation of IP_3 was detected.

Wu et al. (1992) showed that Gq/G11 GTP-binding protein couples the α_1 -adrenoceptors to activate phospholipase C β_1 . Gq/G11 GTP-binding protein is responsible for activation of a phosphatidylinositol-specific phospholipase C leading to production of IP_3 in rat portal vein (Lepretre et al., 1994). The α_{1A} -adrenoceptor stimulation of $[\text{Ca}^{2+}]_i$ and subsequent activation of Ca^{2+} -activated Cl^- current depolarize the membrane and opens the L-type Ca^{2+} channels.

Taken together, these results indicate that activation of the α_1 -adrenoceptor releases Ca^{2+} in rat aorta and portal vein. However, this receptor is not coupled to Ca^{2+} release in ferret aorta and rat anococcygeus muscle, and only weakly coupled to Ca^{2+} release in rat tail artery. This receptor may also be directly coupled to the L-type Ca^{2+} channel and to Ca^{2+} sensitizing mechanism in some types of smooth muscle. In contrast, the α_{2A} -adrenoceptor activation stimulates neither phosphoinositide turnover nor Ca^{2+} release from intracellular stores.

b. CHOLINERGIC MUSCARINIC RECEPTOR AGONISTS. In human tracheal smooth muscle cells in culture (Amrani et al., 1995b), carbachol increased $[\text{Ca}^{2+}]_i$. In guinea pig trachea (Goodman et al., 1987), carbachol increased both $^{45}\text{Ca}^{2+}$ influx and efflux and induced contraction. In canine gastric antrum (Ozaki et al., 1993), acetylcholine increased both $[\text{Ca}^{2+}]_i$ and Ca^{2+} sensitivity. In swine tracheal smooth muscle (Shieh et al., 1991, 1992), acetylcholine induced a contraction with an increase in

$[Ca^{2+}]_i$ and a Ca^{2+} sensitivity. The acetylcholine-induced increases in steady-state $[Ca^{2+}]_i$ and tension were inhibited by the cromakalim-induced hyperpolarization with much less inhibitory effect on the initial transient increase in $[Ca^{2+}]_i$. Cromakalim did not alter the relationship between transient peak tension and $[Ca^{2+}]_i$.

In guinea pig intestinal smooth muscle (Mitsui and Karaki, 1990), carbachol induced an initial transient increase followed by a sustained increase in $[Ca^{2+}]_i$ and muscle tension. Higher concentrations of carbachol induced larger transient changes and smaller sustained changes. High concentrations of carbachol inhibited the high K^+ -stimulated muscle tension and $[Ca^{2+}]_i$. However, Ca^{2+} sensitivity was not changed by carbachol. In the permeabilized muscle strips, however, phorbol ester shifted the Ca^{2+} -tension curve to the lower Ca^{2+} levels (Mitsui and Karaki, 1993). These results suggest that lower concentrations of carbachol increase $[Ca^{2+}]_i$ and induce contraction, whereas high concentrations of carbachol have an additional effect to decrease $[Ca^{2+}]_i$ and inhibit contraction by decreasing $[Ca^{2+}]_i$. The inhibitory effect of high concentrations of carbachol was similar to that of phorbol esters (Mitsui and Karaki, 1993; Mitsui-Saito and Karaki, 1996), suggesting that the inhibitory effect of carbachol is at least partly due to activation of C kinase. Acetylcholine did not have such an inhibitory effect (Mitsui-Saito and Karaki, 1996).

In guinea pig taenia coli, carbachol elicited Ca^{2+} release only at higher concentrations than to increase Ca^{2+} influx in intact tissues (Brading and Sneddon, 1980). In longitudinal smooth muscle of guinea pig ileum (Wang et al., 1992), carbachol increased Ca^{2+} influx at much lower concentrations than needed to increase IP_3 and to release Ca^{2+} from the SR. Oxotremorine and pilocarpine increased Ca^{2+} influx with little effect on Ca^{2+} release. Neomycin, a phospholipase C inhibitor, abolished both IP_3 formation and Ca^{2+} release, but did not affect Ca^{2+} influx. These results suggest that the muscarinic receptor is coupled mainly to Ca^{2+} influx and only weakly to a phospholipase C/ Ca^{2+} release system.

In single smooth muscle cells isolated from rat intestine (Ohta et al., 1994), carbachol produced an initial peak rise in $[Ca^{2+}]_i$ followed by a small sustained rise. In individual cells, the peak rise in $[Ca^{2+}]_i$ did not increase in amplitude even with increasing concentrations of carbachol, although the threshold concentration varied in different cells. The initial peak rise in $[Ca^{2+}]_i$, but not the sustained rise, was due to the release of stored Ca^{2+} , because it was unchanged after removal of external Ca^{2+} or the addition of nifedipine or La^{3+} . In thin muscle bundles, a concentration-dependent contraction was evoked by carbachol in the absence of external Ca^{2+} . Its threshold was similar to those of $[Ca^{2+}]_i$ transient in single cells. These results suggest that carbachol-induced release of stored Ca^{2+} takes place in an all-or-

none fashion in individual cells of the rat intestinal smooth muscle.

In rat aorta (Sato et al., 1990), carbachol increased endothelial $[Ca^{2+}]_i$, released nitric oxide and relaxed smooth muscle with only a small decrease in smooth muscle $[Ca^{2+}]_i$. In the absence of endothelium, carbachol did not change resting tone and resting $[Ca^{2+}]_i$ in vascular smooth muscle.

c. PROSTANOIDS. Prostaglandin $F_{2\alpha}$ increased IP_3 formation and evoked a transient elevation in $[Ca^{2+}]_i$ followed by a sustained increase in $[Ca^{2+}]_i$ in human bronchi (Marmy et al., 1993). Duration of the transient elevation in $[Ca^{2+}]_i$ appeared similar to that of the increase in IP_3 . Prostaglandin $F_{2\alpha}$ and U46619 also released Ca^{2+} from the SR in rat aorta (Fukuo et al., 1986). However, the prostaglandin $F_{2\alpha}$ -induced a transient increase in $[Ca^{2+}]_i$, which is due to Ca^{2+} release, elicited neither a contraction (Ozaki et al., 1990c; Hisayama et al., 1990) nor an increase in MLC phosphorylation (Harada et al., 1996). In ferret aorta, prostaglandin $F_{2\alpha}$ did not appear to release Ca^{2+} (Suematsu et al., 1991b).

In rat aorta (Ozaki et al., 1990c; Hori et al., 1992), prostaglandin $F_{2\alpha}$ induced a sustained increase in $[Ca^{2+}]_i$ and a sustained contraction. Verapamil and removal of external Ca^{2+} strongly inhibited the sustained increase in $[Ca^{2+}]_i$, suggesting that prostaglandin $F_{2\alpha}$ increased Ca^{2+} influx through the L-type Ca^{2+} channel. However, verapamil showed only a small inhibitory effect on prostaglandin $F_{2\alpha}$ -induced contractions (Ozaki et al., 1990c; Hori et al., 1992). Furthermore, prostaglandin $F_{2\alpha}$ or U46619 elicited greater contractions than high K^+ at a given $[Ca^{2+}]_i$ in swine coronary artery (Balwierczak, 1991), rat aorta (Hori et al., 1992), ferret aorta (Suematsu et al., 1991b) and guinea pig aorta (Jiang et al., 1994). Measurements of MLC phosphorylation indicated that prostaglandin $F_{2\alpha}$ caused sustained contraction by both elevating $[Ca^{2+}]_i$ and increasing Ca^{2+} sensitivity of MLC phosphorylation (Suematsu et al., 1991b; Hori et al., 1992). In Ca^{2+} -free solution, prostaglandin $F_{2\alpha}$ also produced a sustained contraction with a transient increase in $[Ca^{2+}]_i$ due to Ca^{2+} release followed by no significant increase in $[Ca^{2+}]_i$ in ferret aorta (Suematsu et al., 1991b) and rat aorta (Ozaki et al., 1990c). This contraction was not accompanied by an increase in MLC phosphorylation in spite of the increments in shortening velocity and stiffness (Hori et al., 1992).

These results indicate that prostaglandin $F_{2\alpha}$ releases Ca^{2+} from the IP_3 -sensitive store in some but not all types of smooth muscle. The transient increase in $[Ca^{2+}]_i$ due to Ca^{2+} release is not always coupled to MLC phosphorylation and contraction. Prostaglandin $F_{2\alpha}$ also opens the L-type Ca^{2+} channel and elicits a sustained increase in $[Ca^{2+}]_i$. Furthermore, prostaglandin $F_{2\alpha}$ increases the Ca^{2+} sensitivity of MLC phosphorylation during sustained contraction. A part of the con-

traction may be due to a mechanism that is not dependent on MLC phosphorylation.

Prostacyclin produced neither contraction nor relaxation of isolated human saphenous vein (Levy, 1978). Rat portal veins and vena cava responded only with an increase in contractile tension when exposed to prostacyclin. Prostacyclin failed to relax high K^+ -contracted vena cava. Prostacyclin analog, iloprost, inhibited the contraction elicited by U46619 or prostaglandin $F_{2\alpha}$ in guinea pig aorta with little effect on high K^+ -induced contraction (Ozaki et al., 1996). Inhibition of contraction followed only a small decrease in $[Ca^{2+}]_i$, suggesting that Ca^{2+} sensitivity was decreased. Iloprost increased cyclic AMP.

d. **ENDOTHELIN-1.** Endothelin-1 (Yanagisawa et al., 1988; Masaki, 1995) acts on the ET_A receptor and elicits sustained contractions with sustained increases in $[Ca^{2+}]_i$ in rat aorta, canine trachea, guinea pig uterus (Sakata et al., 1989), rat carotid artery (Ozaki et al., 1989), swine carotid artery (Rembold, 1990) and rabbit mesenteric artery (Yoshida et al., 1994). However, endothelin-1 induced only small increase in $[Ca^{2+}]_i$ and small contractions in guinea pig vas deferens, taenia coli and ileal longitudinal muscle (Sakata et al., 1989). The initial portion of the increase in $[Ca^{2+}]_i$ is due to formation of IP_3 (Marsden et al., 1989) and resulting Ca^{2+} release (Ozaki et al., 1989; Sakata et al., 1989; Wagner-Mann and Sturek, 1991; Kai et al., 1989). However, the increase in $[Ca^{2+}]_i$ due to Ca^{2+} release did not induce contraction in rat aorta (Sakata et al., 1989) and rat carotid artery (Ozaki et al., 1989). Endothelin-1 did not induce Ca^{2+} release in rat uterus (Sakata and Karaki, 1992).

Sustained increases in $[Ca^{2+}]_i$ due to endothelin-1 were strongly inhibited by removal of external Ca^{2+} and, also, by the Ca^{2+} channel blockers, nicardipine in swine coronary artery (Goto et al., 1989), verapamil and nicardipine in rat aorta (Sakata et al., 1989; Hori et al., 1992), nicardipine in rabbit mesenteric artery (Yoshida et al., 1994), and (-)PN200-110 and nifedipine in rabbit aorta (Benchekroun et al., 1995). In the non-pregnant rat uterus, verapamil strongly inhibited the sustained increase in $[Ca^{2+}]_i$ due to endothelin-1 although verapamil showed only a weak inhibitory effect in pregnant rat uterus (Sakata and Karaki, 1992). These results suggest that endothelin-1 opens the L-type Ca^{2+} channel and elicits a sustained increase in $[Ca^{2+}]_i$. In pregnant rat uterus, however, endothelin-1 may also open a non-L-type Ca^{2+} entry pathway. Enoki et al. (1995a, b) showed that endothelin-1 opens a nonselective cation channel which is permeable to Ca^{2+} (see section II.D.2.).

The endothelin-1-induced contraction was greater than that induced by high K^+ at a given $[Ca^{2+}]_i$ in rat aorta (Sakata et al., 1989; Hori et al., 1992), and swine coronary artery (Kodama et al., 1994). Endothelin-1 also augmented the Ca^{2+} -induced contraction in permeabilized smooth muscle (Nishimura et al., 1992; Yoshida et

al., 1994; Sudjarwo and Karaki, 1995). Endothelin-1 elicited greater MLC phosphorylation than high K^+ at a given $[Ca^{2+}]_i$ in swine carotid artery (Rembold, 1990), rat aorta (Hori et al., 1992) and rabbit mesenteric artery (Yoshida et al., 1994). In rabbit mesenteric artery, the increase in MLC phosphorylation was not altered by changes in $[Ca^{2+}]_i$, suggesting that the increased MLC phosphorylation may be the result of C kinase activation rather than MLC kinase activation (Yoshida et al., 1994; Sudjarwo and Karaki, 1995). In swine coronary artery (Kodama et al., 1994), in contrast, MLC phosphorylation decreased during the sustained contraction, indicating that the increases in Ca^{2+} sensitivity of contraction are not attributable to increased MLC phosphorylation.

In swine pulmonary vein, endothelin-1 acted on the ET_B receptor and increased both $[Ca^{2+}]_i$ and Ca^{2+} sensitivity although it did not induce Ca^{2+} release, indicating that the ET_B receptor is coupled to Ca^{2+} influx but not to Ca^{2+} release (Sudjarwo et al., 1995; Karaki and Matsuda, 1996). In porcine coronary artery (Kasuya et al., 1992) and rat trachea (Henry, 1993), contractions mediated by the ET_B receptor are due to Ca^{2+} influx but not to IP_3 production or Ca^{2+} release. In rabbit saphenous vein, Gray et al. (1994) reported that the ET_B receptor is not coupled to activation of C kinase. In contrast, Sudjarwo and Karaki (1995) reported that the ET_B receptor-mediated contraction is due to activation of C kinase whereas Ca^{2+} sensitization is due only partially to C kinase activation.

Thus, endothelin-1 acts on the ET_A receptor, increases IP_3 production, and releases Ca^{2+} to induce an initial transient increase in $[Ca^{2+}]_i$ in some types of smooth muscle. However, this increase is not always coupled to MLC phosphorylation or contraction. Endothelin-1 also opens the L-type Ca^{2+} channel to induce a sustained increase in $[Ca^{2+}]_i$ and a sustained contraction. Non-L-type Ca^{2+} entry pathway may also be activated. In some smooth muscles, Ca^{2+} sensitivity of contractile elements is increased by endothelin-1. Endothelin-1 also acts on the ET_B receptor, which may be coupled to Ca^{2+} influx pathway and Ca^{2+} sensitization but not to phosphatidylinositol turnover. Stimulation of the ET_B receptor, therefore, increases $[Ca^{2+}]_i$ and induced contraction which is greater than that induced by high K^+ at a given $[Ca^{2+}]_i$ without inducing Ca^{2+} release.

e. **HISTAMINE.** In rat aortic cells in primary culture (Matsumoto et al., 1986, 1989, 1990), histamine activated the histamine H_1 receptor and induced an elevation of $[Ca^{2+}]_i$ of a peak and plateau type. The peak component was due to Ca^{2+} release and the plateau component depended on Ca^{2+} influx. Verapamil and diltiazem inhibited the plateau component. Histamine released Ca^{2+} from the norepinephrine-sensitive store. On the other hand, caffeine had little effect on the histamine-sensitive and norepinephrine-sensitive Ca^{2+} store sites.

In guinea pig trachea cells (Suzuki et al., 1994), $[Ca^{2+}]_i$ response to histamine was an all-or-none type in each cell. The threshold concentration of histamine to increase $[Ca^{2+}]_i$ and peak $[Ca^{2+}]_i$ varied from cell to cell and half-maximal response time was shortened with increasing concentrations of histamine. The heterogeneity in the required threshold concentration of histamine to increase $[Ca^{2+}]_i$, and the concentration dependency in half-maximal response time of the histamine-induced $[Ca^{2+}]_i$ increase may be related to the graded responses of histamine-induced contractions in preparations of the tracheal tissue.

In swine coronary artery strips (Mori et al., 1990a; Hirano et al., 1991), histamine elicited a sustained increase in $[Ca^{2+}]_i$ and a sustained contraction. In Ca^{2+} -free solution, histamine induced only an initial transient increase in $[Ca^{2+}]_i$ and transient contraction. The relationship between $[Ca^{2+}]_i$ and tension in the early, rising phase of contraction was similar to that obtained during high K^+ depolarization. At the time of maximum tension development, histamine-induced contraction was greater than that elicited by high K^+ at a given $[Ca^{2+}]_i$ which persisted in the phase of declining tension.

f. ADENOSINE 5'-TRIPHOSPHATE. In cultured smooth muscle cells of rat aorta (Tawada et al., 1987) and in cultured swine aortic smooth muscle cells (Kalthof et al., 1993), ATP induced a transient increase in $[Ca^{2+}]_i$ due to Ca^{2+} release and rapid production of IP_3 . In myocytes freshly isolated from human saphenous vein (Loirand and Pacaud, 1995), ATP elicited a transient inward current and increased $[Ca^{2+}]_i$. The ATP-gated current corresponded to a nonselective cation conductance allowing Ca^{2+} entry. The ATP-induced $[Ca^{2+}]_i$ rise was abolished in Ca^{2+} -free solution and was reduced when ATP was applied immediately after caffeine or in the presence of thapsigargin. The CICR blocker, tetracaine, inhibited the rise in $[Ca^{2+}]_i$ induced by both caffeine and ATP. These results suggest that the ATP-induced $[Ca^{2+}]_i$ rise is due to both Ca^{2+} entry and CICR activated by Ca^{2+} influx. ATP also released Ca^{2+} in single smooth muscle cells of the rat portal vein (Pacaud and Loirand, 1995). In rat aortic tissues (Kitajima et al., 1994), Ca^{2+} release is mediated by the P_{2YU} purinoceptor whereas Ca^{2+} influx is mediated by both the P_{2X} and the P_{2YU} purinoceptors.

In single smooth muscle cells dissociated from rabbit ear artery (Benham, 1989), ATP opened cation channels and elevated $[Ca^{2+}]_i$. The ATP-activated channels had a dual excitatory function: depolarization due to Na^+ entry promotes action potential discharge and voltage-gated Ca^{2+} entry and, also, direct entry of Ca^{2+} through the ATP-activated channels. In cultured rat aortic smooth muscle cells (Von der Weid et al., 1993), ATP binding to the P_2 -purinoceptors produced increases of $[Ca^{2+}]_i$ and subsequent activation of Ca^{2+} -dependent K^+ and Cl^- currents.

In rat aorta, the ATP-induced increases in $[Ca^{2+}]_i$ were not coupled to contraction (Kitajima et al., 1993, 1994, 1996a), as described in section II.E.1. Similar dissociation was observed in bovine trachea and guinea pig ileum although no such dissociation was observed in rabbit mesenteric artery and guinea pig vas deferens (Karaki et al., 1996).

g. ANGIOTENSIN II. In canine mesenteric artery cells (Sato et al., 1987), angiotensin II induced a transient increase in $[Ca^{2+}]_i$. Contraction induced by angiotensin II was short-lasting. After initial exposure to angiotensin II, subsequently applied angiotensin II generated small contractions. In Ca^{2+} -free solution, angiotensin II also induced a transient contraction. Angiotensin II-induced Ca^{2+} release accompanied IP_3 production (Alexander et al., 1985; Nabika et al., 1985; Dostal et al., 1990).

Angiotensin II induced not only Ca^{2+} release but also Ca^{2+} influx (Koh et al., 1994; Zhu et al., 1994). In the isolated rat renal arteriole (Conger et al., 1993), angiotensin II caused the sustained increases in $[Ca^{2+}]_i$. With diltiazem in the bathing media, angiotensin II caused a transient increase in $[Ca^{2+}]_i$ in afferent arterioles but only a sustained increase in efferent arterioles. In Ca^{2+} -free solution, angiotensin II elicited a transient increase in $[Ca^{2+}]_i$ in both arterioles. In human coronary smooth muscle cells (Kruse et al., 1994), nitrendipine had no significant effect on basal or stimulated $[Ca^{2+}]_i$ after short-term treatment, but decreased basal $[Ca^{2+}]_i$ after a 24 h incubation, attenuated the plateau phase of angiotensin II-evoked $[Ca^{2+}]_i$ transients, and reduced proliferative activity of these cells. These findings indicate that angiotensin II stimulates both Ca^{2+} entry through the L-type Ca^{2+} channels and Ca^{2+} release.

h. PLATELET-DERIVED GROWTH FACTOR. In cultured smooth muscle cells, PDGF increased $[Ca^{2+}]_i$ and induced contraction (Morgan et al., 1985). The increase in $[Ca^{2+}]_i$ followed an activation of phosphatidylinositol turnover in rat mesangial cells (Mene et al., 1987) and cultured human vascular smooth muscle cells (Bochkov et al., 1992). PDGF also increased Ca^{2+} influx through the L-type Ca^{2+} channel in rabbit ear artery cells (Wijetunge and Hughes, 1995) and cultured rat aortic cells (Bendhack et al., 1992). The increase in Ca^{2+} influx elicited by PDGF in rat aorta (Sauro and Thomas, 1993) and rabbit ear artery cells (Wijetunge and Hughes, 1995) were inhibited by tyrosine kinase inhibitors, tyrphostin and genistein. PDGF also activated mitogen-activated protein kinase, phosphorylated cytosolic phospholipase A_2 , released arachidonic acid, increased prostaglandin E_2 synthesis, increased cyclic AMP formation and activated A kinase in human arterial cells (Graves et al., 1996). Calcium release and Ca^{2+} influx induced by PDGF were necessary for initiation of DNA synthesis in cultured rat vascular cells (Mogami and Kojima, 1993).

i. NEUROPEPTIDE Y. Neuropeptide Y induced contraction in canine basilar artery by an increase in $[Ca^{2+}]_i$ through a Ca^{2+} channel blocker-sensitive pathway without changing the Ca^{2+} sensitivity (Tanaka et al., 1995).

3. *Other constrictors.* Sodium fluoride induced sustained contractions in rabbit ear artery and main pulmonary artery in the absence of external Ca^{2+} (Casteels et al., 1981). Sodium fluoride-induced contraction in guinea pig trachea was augmented in the presence of aluminum ion by the direct activation of GTP-binding protein (Leurs et al., 1991). Sodium fluoride elicited greater MLC phosphorylation than high K^+ for given increase in $[Ca^{2+}]_i$ in swine carotid artery and addition of sodium fluoride to high K^+ -depolarized tissues produced similar increases in Ca^{2+} sensitivity of MLC phosphorylation to those elicited by histamine (Rembold, 1990). Aluminum fluoride reversibly increased Ca^{2+} sensitivity of contractile elements in α -toxin-permeabilized rabbit mesenteric artery (Kawase and Van Breemen, 1992). The Ca^{2+} sensitizing effect was inhibited by H-7.

Vanadate is a potent inhibitor of Na^+, K^+ -ATPase derived from bovine aorta (Fox et al., 1983). The Ca^{2+} -ATPase of the same preparation was inhibited at 10 times higher concentrations. Vanadate also inhibited tyrosine phosphatase and augmented phosphorylation elicited by tyrosine kinase (Wong and Goldberg, 1983).

Vanadate elicited contraction in rat aorta which was partially inhibited by verapamil (Fox et al., 1983). Vanadate elicited a transient contraction followed by a sustained contraction in monkey and rabbit trachea by Ca^{2+} release and Ca^{2+} influx without changing Na^+ pump activity (Ueda et al., 1985). $^{45}Ca^{2+}$ uptake into smooth muscle cell increased in the presence of vanadate, but the increase was much less than that induced by high K^+ . In saponin-permeabilized smooth muscle, vanadate inhibited the Ca^{2+} -induced contraction (Sunano et al., 1988). Although vanadate increased vascular tone by elevating $[Ca^{2+}]_i$, higher concentrations of vanadate quenched the fura-2 fluorescence and made the measurements difficult (Sandrasegarane and Gopalakrishnan, 1995). In A7r5 aortic smooth muscle cells (Kaplan and Di Salvo, 1996), vanadate increased tyrosine phosphorylation and induced a slow and small increase in $[Ca^{2+}]_i$ that was dependent on extracellular Ca^{2+} . Genistein blocked tyrosine phosphorylation and the increase in $[Ca^{2+}]_i$ induced by vanadate. In contrast, lavendustin and tyrphostin enhanced tyrosine phosphorylation. Lavendustin produced time-dependent enhancement of the vanadate-induced increase in $[Ca^{2+}]_i$.

4. *Summary.* The effects of smooth muscle stimulants are summarized in table 2. These results indicate that stimulants elicit contraction by increasing $[Ca^{2+}]_i$ and/or increasing Ca^{2+} sensitivity of contractile ele-

TABLE 2
The effects of smooth muscle stimulants and relaxants on $[Ca^{2+}]_i$ and Ca^{2+} sensitivity

	Increase in $[Ca^{2+}]_i$	No change in $[Ca^{2+}]_i$	Decrease in $[Ca^{2+}]_i$
Increase in Ca^{2+} sensitivity	Phenylephrine ^a , norepinephrine ^a , clonidine ^a , tizanidine ^a , acetylcholine ^a , carbachol ^a , U46619 ^a , prostaglandin F _{2α} ^a , endothelin-1 ^a , histamine ^a , phorbol esters ^a , acidosis ^a , halothane ^a , enflurane ^a	Phorbol esters ^a , enflurane ^a , acidosis ^a , okadaic acid ^a , calyculin A ^a	Phorbol esters ^a , acidosis
No change in Ca^{2+} sensitivity	High K^+ depolarization ^a , neuropeptide Y ^a , ATP ^a , carbachol ^a , hypoxia ^a		Ca^{2+} channel blockers, captopril, vasoactive intestinal peptide, TMB-8 (L), 1,9-dideoxyforskolin, reserpine, spiradolone, LP-805, hirsutine, midazolam, trimebutine, hypoxia, estrogen, polyamines
Decrease in Ca^{2+} sensitivity	Caffeine ^a , ATP ^a , vanadate ^a , cyclic AMP, cyclic GMP, adenosine (H), hypoxia, alkalosis, H ₂ O ₂	Cyclic AMP, cyclic GMP, cytochalasines, mycalolide B, okadaic acid	Cyclic AMP, cyclic GMP K ⁺ channel openers, halothane, isoflurane, enflurane, sevoflurane, CGRP, adrenomedullin, insulin, cadralazine, trifluoperazine, azelastin, lidocaine, BDM, KT- 362, lithium hypoxia, cyanide, 2,4-dinitrophenol, adenosine (L), TMB-8 (H), carbachol (E), ATP (E), bradykinin (E), rutacarpine (E)

^a Stimulants.

(H), higher concentrations; (L), lower concentrations; (E), endothelium-dependent relaxation.

ments. The increase in $[Ca^{2+}]_i$ is due mainly to opening of the L-type Ca^{2+} channel and partly to Ca^{2+} release and Ca^{2+} influx through nonselective cation channel and CRAC. Stimulants such as high K^+ and neuropeptide Y increase $[Ca^{2+}]_i$ without changing Ca^{2+} sensitivity whereas various receptor agonists increase both $[Ca^{2+}]_i$ and Ca^{2+} sensitivity. Some stimulants such as caffeine and ATP increase $[Ca^{2+}]_i$, decrease Ca^{2+} sensitivity, and induce only small contractions. This dissociation may be due to either the decrease in Ca^{2+} sensitivity or the increase in noncontractile Ca^{2+} rather than contractile Ca^{2+} .

D. Relaxants

1. Calcium channel blockers. The Ca^{2+} channel blockers are selective inhibitors of the L-type Ca^{2+} channel (see Godfraind et al., 1986). In various types of smooth muscle, Ca^{2+} channel blockers strongly inhibit the high K^+ -induced increase in $[Ca^{2+}]_i$ (for example, see De Feo and Morgan, 1985, 1989; Sumimoto and Kuriyama, 1986; Sato et al., 1988a; Takeuchi et al., 1989b; Hagiwara et al., 1993; Muraki et al., 1993). In single smooth muscle cells, however, Ca^{2+} channel blockers did not inhibit or only partially inhibited the increase in $[Ca^{2+}]_i$ due to acetylcholine (Sumimoto and Kuriyama, 1986), carbachol (Pacaud and Bolton, 1991), norepinephrine (Reynolds and Dubyak, 1986; Pacaud et al., 1992), phenylephrine (Declercq et al., 1990), histamine (Dickenson and Hill, 1992), serotonin (Wang et al., 1991), ATP (Kalthof et al., 1993) and vasopressin (Reynolds and Dubyak, 1986; Takeuchi et al., 1989b; Thibonnier et al., 1991; Hughes and Schachter, 1994). However, others showed that Ca^{2+} channel blockers decreased the $[Ca^{2+}]_i$ in single smooth muscle cells that were elicited by norepinephrine (Nebigil and Malik, 1993), clonidine (Lepretre and Mironneau, 1994), angiotensin II (Kruse et al., 1994), serotonin (Yang et al., 1994b), bradykinin (Yang et al., 1994a), oxytocin (Arnaudeau et al., 1994), insulin (Bkaily et al., 1992), vasopressin (Byron, 1996), endothelin-1 (Suzuki et al., 1991; Gardner et al., 1992; Yang et al., 1994e, f) and sarafotoxin S6b (Yang et al., 1994c). In isolated smooth muscle tissues, Ca^{2+} channel blockers inhibited the increase in $[Ca^{2+}]_i$ induced by norepinephrine (Sato et al., 1988a; Karaki et al., 1991; Hagiwara et al., 1993), α_2 -adrenergic agonists (Lepretre and Mironneau, 1994; Parkinson and Hughes, 1995), PDGF (Hughes, 1995), endothelin-1 (Sakata et al., 1989; Hori et al., 1992; Huang et al., 1993; Benchekroun et al., 1995), serotonin (Godfraind et al., 1992), prostaglandin $F_{2\alpha}$ (Ozaki et al., 1990c) and U46619 (Iwamoto et al., 1993; Yamashita et al., 1994). However, Ca^{2+} channel blockers did not inhibit the increase in $[Ca^{2+}]_i$ in smooth muscle tissues elicited by ATP (Kitajima et al., 1993). These results indicate that the increase in $[Ca^{2+}]_i$ is due not only to the L-type Ca^{2+} channel, which is sensitive to Ca^{2+} channel blockers, but also to Ca^{2+} release and

Ca^{2+} influx through non-L-type Ca^{2+} entry pathways in smooth muscle cells.

In rat aorta, Karaki et al. (1991) found that verapamil decreased the norepinephrine-stimulated $[Ca^{2+}]_i$ more strongly than the contraction whereas verapamil decreased high K^+ -stimulated $[Ca^{2+}]_i$ and contraction in parallel. In the presence of verapamil at a concentration needed to completely inhibit the high K^+ -induced increments, norepinephrine induced a transient increase in $[Ca^{2+}]_i$ due to Ca^{2+} release, followed by a small sustained increase in $[Ca^{2+}]_i$ which averaged 25% of that in the absence of verapamil. These changes were followed by a sustained contraction which averaged 60% of that in the absence of verapamil (fig. 2). In Ca^{2+} -free solution, norepinephrine induced only a transient increase in $[Ca^{2+}]_i$ whereas it induced a transient contraction followed by a small sustained contraction. The second application of norepinephrine induced only a small sustained contraction (10% of that in the presence of Ca^{2+}) without increasing $[Ca^{2+}]_i$. These changes were not affected by verapamil. Felodipine and nifedipine had effects similar to those of verapamil (Hagiwara et al., 1993). These results suggest that the major pathway of Ca^{2+} entry in smooth muscle is the L-type Ca^{2+} channel and a part of the norepinephrine-stimulated Ca^{2+} influx is due to opening of non-L-type pathways. Contractions induced by agonists are less sensitive to Ca^{2+} channel blockers than is the high K^+ -induced contraction, possibly because these blockers do not inhibit agonist-induced Ca^{2+} -sensitization.

Some 1,4-dihydropyridine Ca^{2+} channel blockers have long-term effects. Kim et al. (1992) examined the effects of nisoldipine and found that after nisoldipine had been removed from muscle bath, the inhibitory effect faded away very slowly. The residual inhibitory effects on $[Ca^{2+}]_i$ and muscle tension were antagonized by BAY k8644 and by high concentrations of Ca^{2+} , suggesting that this effect is due to Ca^{2+} antagonism. Ultraviolet light, which has been shown to decompose some 1,4-dihydropyridines, attenuated the residual effects of nisoldipine. From these results, they suggested that the residual effects of nisoldipine are due to tight binding to Ca^{2+} channels even after washout. Spampinato et al. (1993) compared the inhibitory effects of the 1,4-dihydropyridines, lacidipine, nitrendipine, amlodipine, and nifedipine. A7r5 cells were exposed to the 1,4-dihydropyridines and then repeated washout cycles were performed before adding KCl. The Ca^{2+} channel blocking activity of nifedipine and nitrendipine gradually diminished, disappearing after a 3-h washout. Amlodipine and lacidipine displayed slow onset and offset of antagonism, their activity becoming stronger with time in spite of the repeated washes. Lacidipine was avidly and promptly entrapped in A7r5 cells and was not removed by washout. However, its potency as a Ca^{2+} channel blocker was not directly related to the amount of drug locked in the cell since it increased with time, indicating that lacidipine

ine binds to the lipid bilayer of the cell membrane and then gradually diffuses toward a specific binding site.

It has been shown that Ca^{2+} channel blockers have multiple sites of action other than L-type Ca^{2+} channel, including ion channels, exchangers and enzymes (see Zernig, 1990). Verapamil inhibits not only L-type Ca^{2+} channels but also Na^+ channels (Shigenobu et al., 1974), α_1 -adrenoceptors (Bhalla and Sharma, 1986) and α_2 -adrenoceptors (Cavero et al., 1983). In rat aorta, Murakami et al. (1995) compared the effects of Ca^{2+} channel blockers, diltiazem, bepridil, benzothiazine derivative, semotiadil fumarate, and its (S)-(-)-enantiomer (SD-3212). These blockers inhibited the contraction induced by high K^+ accompanied by a decrease in $[\text{Ca}^{2+}]_i$. However, diltiazem and bepridil inhibited neither the increase in $[\text{Ca}^{2+}]_i$ nor the contraction induced by norepinephrine. In contrast, semotiadil and SD-3212 inhibited only the early phase of the increase in $[\text{Ca}^{2+}]_i$ induced by norepinephrine. After 5 min, no significant effect on $[\text{Ca}^{2+}]_i$ was observed with these compounds despite the significant decrease in the contraction. Semotiadil and SD-3212 inhibited the transient contraction induced by norepinephrine in the absence of external Ca^{2+} . Both compounds partially but significantly inhibited the norepinephrine-induced contraction in nifedipine-treated muscles. These results suggest that semotiadil and SD-3212 inhibit contractions of vascular smooth muscle not only through blockade of the L-type Ca^{2+} channels but also through inhibition of Ca^{2+} release and a decrease in Ca^{2+} sensitivity.

2. Potassium channel openers. Potassium channel openers comprise a diverse group of molecules. These compounds open K^+ channels, hyperpolarize the membrane, inhibit the opening of the L-type Ca^{2+} channel, inhibit Ca^{2+} influx, decrease $[\text{Ca}^{2+}]_i$, and inhibit contraction (Weston and Edwards, 1992; Kuriyama et al., 1995). In rat aortic cells (Morimoto et al., 1987), nicorandil inhibited the increase in $[\text{Ca}^{2+}]_i$ evoked by angiotensin II or prostaglandin $\text{F}_{2\alpha}$. In the femoral artery of guinea pigs (Nakajima et al., 1989), pinacidil decreased $[\text{Ca}^{2+}]_i$ and inhibited the contraction induced by high K^+ . These results are consistent with the idea that K^+ channel openers decrease $[\text{Ca}^{2+}]_i$.

Anabuki et al. (1990) showed that pinacidil has multiple sites of action. In rat aorta, pinacidil inhibited the increases in $[\text{Ca}^{2+}]_i$ and muscle tension due to norepinephrine. In contrast, verapamil inhibited the norepinephrine-stimulated $[\text{Ca}^{2+}]_i$ more strongly than the contraction (because norepinephrine increases both $[\text{Ca}^{2+}]_i$ and Ca^{2+} sensitivity and verapamil decreases $[\text{Ca}^{2+}]_i$ but not Ca^{2+} sensitivity). Higher concentrations of pinacidil (higher than 3 mM) inhibited the verapamil-insensitive portion of the contraction and $[\text{Ca}^{2+}]_i$. Glibenclamide antagonized the inhibitory effects of low concentrations (10 mM or less) of pinacidil but not those of high concentrations. Norepinephrine (in the presence of GTP), PDBu, and treatment with $\text{GTP}\gamma\text{S}$ potentiated

the Ca^{2+} -induced contraction of permeabilized smooth muscle. Pinacidil inhibited the Ca^{2+} sensitization due to $\text{GTP}\gamma\text{S}$ or norepinephrine but not to phorbol ester. These results suggest that pinacidil has dual effects on vascular smooth muscle contraction; to decrease $[\text{Ca}^{2+}]_i$ by activating K^+ channels, and to directly inhibit the receptor-mediated, GTP binding protein-coupled Ca^{2+} sensitization. Itoh et al. (1991) showed that pinacidil also directly inhibits contractile elements in rabbit mesenteric artery.

Taira and co-workers, in canine and porcine coronary arteries (Yanagisawa et al., 1990, 1993; Yamagishi et al., 1992a, b; Okada et al., 1993a, b), and Kuriyama and co-workers, in rabbit mesenteric artery (Ito et al., 1991b; Itoh et al., 1992), found that K^+ channel openers inhibit agonist-induced Ca^{2+} release. These inhibitors inhibited the production of IP_3 and Ca^{2+} release from the SR, decreased $[\text{Ca}^{2+}]_i$ and inhibited contraction induced by U46619 or norepinephrine. The K^+ channel blockers, tetrabutylammonium and glibenclamide, abolished the effects of cromakalim, levcromakalim, and Ki 4032, whereas these blockers only slightly attenuated the relaxant effects of pinacidil, KRN 2391 and nicorandil. Cromakalim and Ki 4032 only partially inhibited the 30 mM KCl-induced contractions, whereas pinacidil, nicorandil, and KRN 2391 nearly abolished contractions produced by higher concentrations of K^+ . Thus, cromakalim, levcromakalim and Ki 4032 are more specific K^+ channel openers than pinacidil, nicorandil, and KRN 2391. Ki 1769 showed effects similar to those of cromakalim (Yokoyama et al., 1995). In β -escin-skinned strips, levcromakalim did not inhibit the Ca^{2+} release induced by norepinephrine. Y-26763 showed effects similar to those of cromakalim (Itoh et al., 1994a). Thus, the vasodilation related to reduction of $[\text{Ca}^{2+}]_i$ produced by K^+ channel openers is due to hyperpolarization of the plasma membrane resulting in not only the closure of voltage-dependent Ca^{2+} channels but also inhibition of the production of IP_3 and Ca^{2+} release from the SR. Okada et al. (1993a, b) reported that the membrane hyperpolarization induced by levcromakalim and KRN 2391 decreases Ca^{2+} -sensitivity of the contractile elements in canine coronary arteries.

In rat aorta, in contrast, Yamashita et al. (1994) showed that NIP-121 and cromakalim did not inhibit the norepinephrine-induced transient contractions and the increased $[\text{Ca}^{2+}]_i$ due to Ca^{2+} release. In rabbit femoral artery, Abe et al. (1994) also found that, although nicorandil inhibited Ca^{2+} release induced by norepinephrine, cromakalim had no such effects. Since nicorandil increased cyclic GMP (Holzmann, 1983; Schmidt et al., 1985; Abe et al., 1994) and increased the activity of Ca^{2+} -ATPase in the microsomal fraction of porcine coronary artery (Morimoto et al., 1987), inhibition of Ca^{2+} release may be due to activation of G kinase. These results may indicate the existence of tissue differences

in the inhibitory effects of K^+ channel openers on SR Ca^{2+} release.

Iwamoto et al. (1993) compared the vasorelaxant effects of the K^+ channel openers, pinacidil and cromakalim, with those of the Ca^{2+} channel blockers, verapamil and 1-[bis(4-fluorophenyl)methyl]-4-(2,3,4-trimethoxybenzyl)piperazine dihydrochloride (KB-2796), in canine arteries precontracted with U46619. The relaxant effects of pinacidil and cromakalim were in the order of coronary > renal > basilar > mesenteric arteries. The relaxant effects of verapamil and KB-2796, in contrast, were in the order of basilar > coronary > renal = mesenteric arteries.

Trongvanichnam et al. (1996a) showed that, in the aorta isolated from rats orally given a high dose of levcromakalim for 2 weeks, the inhibitory effect of levcromakalim itself was reduced. Furthermore, the inhibitory effects of sodium nitroprusside and 8-bromo-cyclic GMP were also attenuated although the effects of verapamil and forskolin were unchanged. The aorta did not lose the ability to produce cyclic GMP in response to sodium nitroprusside or 3-isobutyl-1-methylxanthine. In the aorta isolated from levcromakalim-pretreated SHR, basal tone was high and spontaneous oscillatory contractions were observed. These changes were inhibited by verapamil, supporting the suggestion that the L-type Ca^{2+} channels are activated (Sada et al., 1990). The effects of repeated levcromakalim administration were similar to those of a slight membrane hyperpolarization by high K^+ . These results suggest that continuous opening of K^+ channels by levcromakalim either closed the K^+ channels or decreased the number of K^+ channels, depolarized the membrane, and activated the L-type Ca^{2+} channels. These results also suggest that one of the actions of cyclic GMP is to open K^+ channels which are inactivated by levcromakalim-pretreatment.

In the aorta isolated from rats orally given a high dose of nicorandil for 4 weeks (Trongvanichnam et al., 1996b), the inhibitory effect of nicorandil itself, sodium nitroprusside, nitric oxide, endothelium-derived relaxing factor released by carbachol, 8-bromo-cyclic GMP, levcromakalim, and forskolin were reduced. However, the inhibitory effect of verapamil was not changed. The ability of the nicorandil-pretreated aorta to produce cyclic GMP in response to nicorandil and sodium nitroprusside was reduced. In contrast, a 4-week oral administration of isosorbide dinitrite to the rats did not change the response of aorta to sodium nitroprusside and levcromakalim although the response to isosorbide dinitrite itself was attenuated (Trongvanichnam et al., 1996c). These results support the suggestion that nicorandil acts on both K^+ channels and cyclic GMP system to induce relaxation. Furthermore, nicorandil does not seem to desensitize the nitric oxide-generating step although isosorbide dinitrite desensitizes this step.

3. Other relaxants.

a. CALCITONIN GENE-RELATED PEPTIDE AND ADRENOMEDULLIN. Calcitonin gene-related peptide (CGRP) (Amara et al., 1982; Feuerstein and Hallenbeck, 1987; Poyner, 1995) is a potent vasodilator that acts to increase cyclic AMP (Kubota et al., 1985; Hirata et al., 1988; Kageyama et al., 1993) and to activate K^+ channels (Nelson et al., 1990; Kitazono et al., 1993). In rat aorta (Ishikawa et al., 1993), CGRP inhibited norepinephrine-induced contraction and decreased $[Ca^{2+}]_i$. The effects of CGRP were augmented by an inhibitor of phosphodiesterase, 3-isobutyl-1-methylxanthine, and were inhibited by an inhibitor of A kinase, the R_p -diastereomer of cyclic AMP. Also, in rat aorta (Yoshimoto et al., to be published), CGRP increased endothelial $[Ca^{2+}]_i$ and induced endothelium-dependent relaxation. In the absence of endothelium, CGRP was almost ineffective. In swine coronary artery, in contrast, CGRP induced relaxation in the absence of endothelium accompanied by a decrease in smooth muscle $[Ca^{2+}]_i$ and an increase in cyclic AMP.

Adrenomedullin is a newly identified vasorelaxant peptide with a structure similar to that of CGRP (Kitamura et al., 1993; Nuki et al., 1993). In swine coronary artery (Kureishi et al., 1995) and renal artery (Seguchi et al., 1995), adrenomedullin inhibited both the elevations of $[Ca^{2+}]_i$ and contractions induced by high K^+ , U46619 or phenylephrine. In α -toxin-permeabilized strips, adrenomedullin decreased contraction at constant Ca^{2+} in the presence of GTP, whereas $GDP\beta S$ antagonized this effect. These results suggest that adrenomedullin relaxes the coronary artery not only by decreasing $[Ca^{2+}]_i$ but also by decreasing the Ca^{2+} -sensitivity of the contractile elements. In rat aorta (Yoshimoto et al., to be published), however, adrenomedullin increased endothelial $[Ca^{2+}]_i$ and induced endothelium-dependent relaxation. In the absence of endothelium, adrenomedullin was ineffective.

b. INSULIN. Insulin either increased (Zhu et al., 1993a; Touyz et al., 1994) or did not change resting $[Ca^{2+}]_i$ (Han et al., 1995b). Insulin attenuated the increase in $[Ca^{2+}]_i$ elicited by serotonin in cultured vascular smooth muscle cells from dog femoral artery only in the presence of glucose (Kahn et al., 1995), by endothelin-1 in porcine coronary artery cells (Dick and Sturek, 1996), by angiotensin II and arginine-vasopressin in primary unpassaged cultured rat mesenteric artery cells (Touyz et al., 1994, 1995), and by serotonin in primary confluent canine femoral artery cells (Kahn et al., 1993, 1994). In contrast, insulin augmented the increase in $[Ca^{2+}]_i$ elicited by angiotensin II in A7r5 cells (Kim and Zemel, 1993). Insulin also caused a marked increase in the rate of $[Ca^{2+}]_i$ recovery to baseline after stimulation with both angiotensin II and vasopressin, such that the cumulative exposure to elevated $[Ca^{2+}]_i$ after stimulation with either agonist (i.e., area under the $[Ca^{2+}]_i$ curve) was reduced with insulin treatment (Kim and Zemel,

1993). Similar results were reported by Touyz et al. (1995).

Han et al. (1995b) showed that, in rat aorta precontracted with norepinephrine, insulin inhibited contraction accompanied by a decrease in smooth muscle $[Ca^{2+}]_i$ and an increase in endothelial $[Ca^{2+}]_i$. In the absence of endothelium, insulin still relaxed the norepinephrine-contracted aorta accompanied by a decrease in $[Ca^{2+}]_i$. Thus, insulin appears to have dual effects. The first effect is to increase endothelial $[Ca^{2+}]_i$, activate nitric oxide synthase, release nitric oxide, and indirectly inhibit smooth muscle contraction by the decreases in both $[Ca^{2+}]_i$ and Ca^{2+} sensitivity. The second effect is to directly act on smooth muscle and inhibit the agonist-induced increase in $[Ca^{2+}]_i$.

c. VOLATILE ANESTHETICS. In A10 cells (Iaizzo, 1992), halothane and isoflurane transiently increased $[Ca^{2+}]_i$. These volatile anesthetics inhibited the increases in $[Ca^{2+}]_i$ elicited by acetylcholine, endothelin-1, histamine, serotonin and vasopressin. In A7r5 cells (Sill et al., 1991), halothane also inhibited $[Ca^{2+}]_i$ responses and inositol phosphate formation evoked on stimulation with arginine-vasopressin. Inhibition of Ca^{2+} release was stronger than that of Ca^{2+} influx. In cultured rat aortic smooth muscle cells (Fujihara et al., 1996), arginine-vasopressin elicited an initial transient increase in $[Ca^{2+}]_i$ in the perinuclear region that was higher than $[Ca^{2+}]_i$ in the cytoplasm. Halothane attenuated the $[Ca^{2+}]_i$ increase induced by arginine-vasopressin and abolished the differential increase. Under the continuous application of stimulant, Ca^{2+} restoration in the medium after perfusion with Ca^{2+} -free solution increased perinuclear $[Ca^{2+}]_i$ more than the cytosolic $[Ca^{2+}]_i$. Both were significantly attenuated by halothane but not by nifedipine or ryanodine. These results suggest that halothane may attenuate Ca^{2+} release from the SR more strongly than the Ca^{2+} entry. In permeabilized rabbit aorta and femoral artery (Su, 1996; Su and Zhang, 1989; Su et al., 1994), isoflurane, enflurane and halothane decreased Ca^{2+} uptake by the SR, and enhanced caffeine-induced Ca^{2+} release from the SR.

In canine mesenteric artery (Kakuyama et al., 1994), halothane and enflurane, but not isoflurane, induced a transient increase in $[Ca^{2+}]_i$ and a transient contraction. Ryanodine completely abolished the transient increases in tension and $[Ca^{2+}]_i$. Even in ryanodine-treated arteries, however, both anesthetics induced a slowly developing sustained contraction. The sustained contraction induced by enflurane was not accompanied by a significant increase in $[Ca^{2+}]_i$, suggesting an increase in Ca^{2+} sensitivity.

In contrast to the above results, halothane and isoflurane increased resting $[Ca^{2+}]_i$ without inducing contraction in rat aorta (Tsuchida et al., 1993). Halothane and isoflurane attenuated the increase in $[Ca^{2+}]_i$ and contraction induced by high K^+ and norepinephrine. During exposure to halothane or isoflurane, addition of BAY

k8644 caused recovery of the high K^+ -stimulated $[Ca^{2+}]_i$. However, the high K^+ -induced contraction was not recovered by BAY k8644. Also, in rat aorta (Namba and Tsuchida, 1996), halothane and isoflurane inhibited contractions more strongly than $[Ca^{2+}]_i$ stimulated by norepinephrine and prostaglandin $F_{2\alpha}$. Pretreatment of the muscle strip with verapamil revealed that halothane and isoflurane released Ca^{2+} during the norepinephrine-induced contraction. Halothane and isoflurane suppressed contractions elicited by di-*tert*-butyl peroxide that were accompanied by increases in $[Ca^{2+}]_i$. These results suggest that the anesthetics decrease not only $[Ca^{2+}]_i$ but also Ca^{2+} sensitivity. Halothane and isoflurane also inhibited the high K^+ -induced contraction and the accompanying increase in $[Ca^{2+}]_i$ in rat aorta (Tsuchida et al., 1994). However, halothane, but not isoflurane, augmented the caffeine-induced contraction and the increase in $[Ca^{2+}]_i$ in Ca^{2+} -free solution. Thus, halothane, but not isoflurane, may enhance Ca^{2+} release from the caffeine-releasable Ca^{2+} stores. In porcine coronary artery (Ozhan et al., 1994), isoflurane attenuated contractions and increased $[Ca^{2+}]_i$ evoked by serotonin but not those induced by endothelin-1 or PDBu. Halothane attenuated contractions and increase in $[Ca^{2+}]_i$ evoked by serotonin and endothelin-1 but lacked effect on phorbol ester-induced responses. Neither anesthetic facilitated cyclic AMP formation.

Halothane relaxed not only vascular smooth muscle but also airway smooth muscle. In canine trachea stimulated by acetylcholine (Jones et al., 1993), halothane caused a reduction in sustained force but no decrease in plateau aequorin signal. In canine trachea (Jones et al., 1995), acetylcholine increased force, cyclic AMP, cyclic GMP, and $[Ca^{2+}]_i$. Subsequent exposure of the strips to halothane caused an additional increase in cyclic AMP, the decreases in force and $[Ca^{2+}]_i$, and no effect on cyclic GMP. Indomethacin abolished the increase in cyclic AMP produced by acetylcholine and abolished the additional increase in cyclic AMP produced by halothane. In contrast, indomethacin had no effect on the decreases in force and $[Ca^{2+}]_i$. These findings suggest that halothane increased cyclic AMP by a cyclooxygenase-dependent mechanism and that the increase in cyclic AMP produced by halothane is not responsible for the relaxation or the decrease in $[Ca^{2+}]_i$. Also, in canine trachea (Yamakage et al., 1993), carbachol increased muscle tension and $[Ca^{2+}]_i$. Anesthetics decreased both muscle tension and $[Ca^{2+}]_i$ in the following order of inhibitory potency: halothane > isoflurane > enflurane > sevoflurane. In the presence of verapamil, carbachol moderately increased muscle tension but induced a transient increase of $[Ca^{2+}]_i$ followed by a substantial reduction. In the presence of both carbachol and verapamil, anesthetics significantly decreased muscle tension without decreasing $[Ca^{2+}]_i$. Potency for suppression of tension under these conditions, which appeared to be due to decrease in Ca^{2+} sensitivity, was correlated with the oil/gas par-

tition coefficient: halothane > enflurane = isoflurane > sevoflurane. These results suggest that anesthetics inhibit tracheal smooth muscle contraction by a decreasing both $[Ca^{2+}]_i$ and Ca^{2+} sensitivity, the latter of which may be related to disruption of membrane phospholipids.

In bovine aortic endothelial cells (Simoneau et al., 1996), halothane and isoflurane reversibly reduce the sustained increase in $[Ca^{2+}]_i$ initiated by bradykinin or thapsigargin, possibly by membrane depolarization caused by an inhibition of the Ca^{2+} -dependent K^+ channel activity. In canine mesenteric arteries (Yoshida and Okabe, 1992), sevoflurane inhibited the endothelium-dependent vasodilatation induced by acetylcholine, bradykinin, and Ca^{2+} ionophore, A23187, without changing the relaxation induced by nitroglycerin. The electron spin resonance spin-trapping with 5,5-dimethyl-1-pyrroline *N*-oxide verified generation of hydroxyl radical from the sevoflurane-delivered bathing media. The generation of hydroxyl radical and inhibition of endothelium-dependent relaxation were inhibited by superoxide dismutase. In rabbit lingual artery (Sasaki and Okabe, 1993), exogenous hydroxyl radicals also attenuated endothelium-dependent relaxation. These results indicate that superoxide anion radical and/or closely related species of oxygen free radicals, possibly hydroxyl radical, are involved in the inhibitory effect of sevoflurane on inactivation of endothelium-derived relaxing factor.

d. ANGIOTENSIN-CONVERTING ENZYME INHIBITORS. In cultured rat vascular smooth muscle cells (Zhu et al., 1994), angiotensin-converting enzyme inhibitors (captopril, enalaprilat and ramiprilat) inhibited Ca^{2+} influx but not Ca^{2+} release induced by angiotensin II. In rat aortic cells (Zhu et al., 1993b), captopril and enalapril inhibited the increase in $[Ca^{2+}]_i$ in response to angiotensin II and bradykinin by inhibiting Ca^{2+} influx. In swine coronary artery (Hirano and Kanaide, 1993), captopril augmented both the endothelium-dependent relaxation and the decrease in smooth muscle $[Ca^{2+}]_i$ induced by bradykinin without changing the Ca^{2+} sensitivity or affecting the contractile elements.

e. HYPOXIA AND METABOLIC INHIBITION. Hypoxia increased $[Ca^{2+}]_i$ and induced contraction in primary cultured smooth muscle cells from pulmonary arteries (Vadula et al., 1993; Hu and Wang, 1994). Acute hypoxia also increased $[Ca^{2+}]_i$ in distal pulmonary artery cells from late-gestation ovine fetuses, and this was absent in Ca^{2+} -free solution (Cornfield et al., 1993). Increases in $[Ca^{2+}]_i$ in distal pulmonary artery cells were due to membrane depolarization and the resulting opening of a verapamil-sensitive L-type Ca^{2+} channel (Cornfield et al., 1994). In rabbit corpus cavernosum (Kim et al., 1996a), hypoxia increased $[Ca^{2+}]_i$ and induced relaxation. In freshly dispersed rabbit femoral artery cells (Franco-Obregon et al., 1995), hypoxia decreased $[Ca^{2+}]_i$. In rabbit aorta (Karakaki and Weiss, 1987), hypoxia inhibited norepinephrine-induced contraction with

no effect on $^{45}Ca^{2+}$ influx. In the cells from large pulmonary and cerebral artery (Vadula et al., 1993), hypoxia decreased $[Ca^{2+}]_i$ and induced relaxation. Hypoxia did not change $[Ca^{2+}]_i$ in proximal pulmonary artery cells and decreased $[Ca^{2+}]_i$ in carotid artery cells. In rat portal vein (Sward et al., 1993), metabolic inhibition by cyanide or 2,4-dinitrophenol increased basal $[Ca^{2+}]_i$, and inhibited high K^+ -induced contraction with no change in $[Ca^{2+}]_i$, suggesting that Ca^{2+} sensitivity is decreased or contractile elements are inhibited. In contrast, Vadula et al. (1993) suggested that hypoxia did not change Ca^{2+} sensitivity. Thus, there are large tissue differences in the effects of hypoxia and metabolic inhibition of $[Ca^{2+}]_i$ and Ca^{2+} sensitivity. In rabbit aorta (Karakaki and Weiss, 1987), low temperature (24°C) inhibited contractions induced by high K^+ or norepinephrine accompanied by decreases in $^{45}Ca^{2+}$ influx.

f. MAGNESIUM ION. In rat aortic cells (Zhang et al., 1992), removal of external Mg^{2+} increased $[Ca^{2+}]_i$ and changed cell shape. In rabbit aorta and ear artery, rat aorta and guinea pig aorta, removal of external Mg^{2+} gradually augmented the caffeine-induced contraction without changing the contraction induced by norepinephrine or high K^+ , possibly by decreasing cytosolic Mg^{2+} level and activating CICR (Karakaki et al., 1987). In rabbit urinary bladder detrusor muscle (Yu et al., 1995), addition of Mg^{2+} inhibited carbachol-induced contraction accompanied by a decrease in $[Ca^{2+}]_i$. In porcine trachea (Kumasaka et al., 1996), addition of Mg^{2+} inhibited contractions and increased $[Ca^{2+}]_i$ elicited with high K^+ or carbachol. In rat carotid artery (Karakaki, 1989b), addition of Mg^{2+} relaxed contraction induced by high K^+ accompanied by a decrease in $[Ca^{2+}]_i$. In swine carotid artery (D'Angelo et al., 1992), addition of Mg^{2+} decreased histamine-stimulated $[Ca^{2+}]_i$ and force to resting values. However, Mg^{2+} only transiently decreased MLC phosphorylation, suggesting that Mg^{2+} induces relaxation by decreasing $[Ca^{2+}]_i$ and, also, by dissociating MLC phosphorylation from $[Ca^{2+}]_i$ and force. This finding also suggests the presence of an MLC phosphorylation-independent (yet potentially Ca^{2+} -dependent) mechanism for regulation of force in vascular smooth muscle.

In the aorta isolated from rats fed with a Mg^{2+} -deficient diet for 30 days (Nishio et al., 1989), contraction and the increase in $^{45}Ca^{2+}$ uptake due to norepinephrine were significantly greater than those in the aorta isolated from rats fed with normal diet. However, there were no significant differences between control rat aorta and Mg^{2+} -deficient rat aorta in the responses to high K^+ . Verapamil and nifedipine inhibited norepinephrine-induced contraction in Mg^{2+} -deficient rat aorta more strongly than that in the control rat aorta. Similar results were obtained with phenylephrine (Sakaguchi and Nishio, 1994) and PDBu (Sakaguchi et al., 1995). Furthermore, both phenylephrine and PDBu decreased the K_d value and increased the B_{max} for the binding of

[³H]PN200-110 to the aorta and the decrease in the K_d value was significantly greater in the Mg^{2+} -deficient rat aorta. The effects of Mg^{2+} -deficiency were antagonized by H-7. These results suggest that, in the Mg^{2+} -deficient rat aorta, the α_1 -adrenoceptor-coupled L-type Ca^{2+} channel activity is increased. Activation of C kinase may participate in the activation of L-type Ca^{2+} channels, which increases both the affinity of PN200-110 and the amount of Ca^{2+} influx. Dietary Mg^{2+} -deficiency may enhance these processes.

g. ACIDOSIS AND ALKALOSIS. Effects of pH on smooth muscle contractions have been reviewed by Wray et al. (1996). In A7r5 cells (Siskind et al., 1989), intracellular alkalinization increased $[Ca^{2+}]_i$ by releasing Ca^{2+} . In rabbit portal vein (Iino et al., 1994b), intracellular alkalinization elicited by ammonium ion inhibited the high K^+ -induced contraction and decreased $[Ca^{2+}]_i$ whereas intracellular acidification augmented the high K^+ -induced contraction and increased $[Ca^{2+}]_i$. In porcine coronary artery (Nagesetty and Paul, 1994), intracellular alkalinization increased $[Ca^{2+}]_i$ and inhibited contraction induced by high K^+ or U46619. In canine trachea (Yamakage et al., 1995), acidification decreased $[Ca^{2+}]_i$ without changing muscle tone. Kitajima et al. (1996b) showed that changes in pH in the cell changed K_d value of fura-2 for Ca^{2+} . Adjusting the changes in K_d value, they showed that changes in external pH elicited concomitant changes in intracellular pH in 4-(2-hydroxyethyl)-1-piperazineethanesulfonic acid buffer solution. Acidification increased both $[Ca^{2+}]_i$ and muscle tone by opening of the L-type Ca^{2+} channels (Furukawa et al., 1996). This effect was due mainly to acidic pH outside the cell. During high K^+ -induced contraction, acidosis decreased $[Ca^{2+}]_i$ without changing contraction (Kitajima et al., 1996b). In permeabilized rat portal vein and human umbilical artery (Crichton et al., 1994), the Ca^{2+} sensitivity of tension production was not significantly affected by acidic pH in either preparation. However, alkaline pH caused a similar fall in the Ca^{2+} sensitivity in both preparations. These results suggest that acidification increases and alkalinization decreases the Ca^{2+} sensitivity of the contractile elements. In rat mesenteric artery (Austin and Wray, 1995), in contrast, acidification did not change Ca^{2+} sensitivity. In rat aorta (Karaki and Weiss, 1981a), intracellular alkalinization (or a decrease in transmembrane pH gradient) inhibited relaxation due to membrane hyperpolarization following the activation of the electrogenic Na^+ pump.

In the SR, alkalinization increased the Ca^{2+} sensitivity of IP_3 -induced Ca^{2+} release in permeabilized guinea pig portal vein (Tsukioka et al., 1994).

h. ESTROGEN. In porcine coronary arterial strips, Han et al. (1995a) and Orimo et al. (1995) reported that 17- β -estradiol inhibited the increases in $[Ca^{2+}]_i$ and contractions induced by high K^+ . In contrast, contractions elicited by U46619 were only partially inhibited despite complete inhibition of the sustained increase in $[Ca^{2+}]_i$.

Verapamil also only partially inhibited the U46619-induced sustained contraction and subsequent addition of 17- β -estradiol did not have an additional inhibitory effect on either the $[Ca^{2+}]_i$ or tension after addition of verapamil. These results suggest that 17- β -estradiol has an effect similar to that of Ca^{2+} channel blockers, inhibition of Ca^{2+} influx without changing Ca^{2+} sensitivity.

i. ACTIN INHIBITORS. Cytochalasins depolymerize actin filaments. In guinea pig taenia coli (Obara and Yabu, 1994), cytochalasin B inhibited the high K^+ -induced contraction, and decreased ATPase activity in permeabilized taenia coli. However, cytochalasin B had no effect on the voltage-dependent Ca^{2+} currents, MLC phosphorylation and $[Ca^{2+}]_i$. In the rat aorta and chicken gizzard smooth muscles (Saito et al., 1996), cytochalasin D inhibited the contraction induced by high K^+ or norepinephrine without changing $[Ca^{2+}]_i$. In the absence of external Ca^{2+} , DPB induced sustained contraction without increasing $[Ca^{2+}]_i$. Cytochalasin D also inhibited this contraction. In the permeabilized chicken gizzard smooth muscle, cytochalasin D inhibited the Ca^{2+} -induced contraction. Cytochalasin D also inhibited the Ca^{2+} -independent contraction in the muscle which had been thiophosphorylated by adenosine 5'-O-(thiotriphosphate). Cytochalasin D decreased the velocity of superprecipitation in the chicken gizzard native actomyosin (myosin B) affecting neither the level of MLC phosphorylation nor the Mg^{2+} -ATPase activity. These results suggest that cytochalasin D inhibits smooth muscle contractions without any effect on the Ca^{2+} -dependent MLC phosphorylation or subsequent activation of myosin ATPase activity. Cytochalasins may depolymerize actin in smooth muscle cells and inhibit contraction by uncoupling the force generation from the activated actomyosin Mg^{2+} -ATPase.

A toxin isolated from marine sponge, mycalolide B, severs F-actin, sequesters G-actin, and thus depolymerizes actin filaments (Saito et al., 1994). In rat aorta (Hori et al., 1993a), mycalolide B inhibited contractions induced by high K^+ and caffeine without changing $[Ca^{2+}]_i$. It also inhibited Ca^{2+} -induced contraction in permeabilized smooth muscles. In the chicken gizzard native actomyosin, mycalolide B inhibited superprecipitation and Mg^{2+} -ATPase activity stimulated by Ca^{2+} without changing MLC phosphorylation. In the permeabilized muscle and the native actomyosin preparation thiophosphorylated with adenosine 5'-O-(thiotriphosphate), mycalolide B inhibited both ATP-induced contraction and Mg^{2+} -ATPase activity in the absence of Ca^{2+} . Mycalolide B also inhibited Mg^{2+} -ATPase activity of the skeletal muscle native actomyosin. Mycalolide B had no effect on the calmodulin-stimulated Ca^{2+} -ATPase activity of erythrocyte membranes. These results suggest that mycalolide B selectively inhibits actin-myosin interaction and inhibits smooth muscle contraction. Aplyronine A and bistheonellide A, the marine toxins with a similar

actin depolymerizing activity, showed effects similar to those of mycalolide B (Saito and Karaki, 1996).

j. OTHERS. Vasoactive intestinal peptide inhibited the contraction induced by carbachol but not those caused by high K^+ or caffeine in rat stomach circular muscle (Ohta et al., 1991). In Ca^{2+} -free solution, vasoactive intestinal peptide inhibited the phasic contraction induced by carbachol, but not that induced by caffeine. Vasoactive intestinal peptide reduced the increase in $[Ca^{2+}]_i$ elicited by carbachol without changing the $[Ca^{2+}]_i$ -force relationship. In the permeabilized muscle fibers, vasoactive intestinal peptide had no effect on the Ca^{2+} -tension relationship. These results suggest that the inhibitory effects of vasoactive intestinal peptide are due to the inhibition of the processes of signal transduction from muscarinic receptors to voltage-dependent Ca^{2+} channels and to intracellular Ca^{2+} stores.

Adenosine pretreatment inhibited contraction and the increase in $[Ca^{2+}]_i$ elicited by high K^+ , phenylephrine or electrical stimulation in ferret portal vein (Bradley and Morgan, 1985). In contrast, the addition of adenosine during phenylephrine or high K^+ -induced contractions decreased force without a change in $[Ca^{2+}]_i$. Concentration-response curves for the effects of adenosine on high K^+ -induced contraction indicated that at low concentrations adenosine decreased force and $[Ca^{2+}]_i$ but that at high concentrations (greater than $3.7 \mu M$) adenosine increased $[Ca^{2+}]_i$ and apparently relaxed smooth muscle by desensitizing the myofilaments to $[Ca^{2+}]_i$.

Cadralazine becomes effective when metabolized to ISF-2405 (Higashio and Kuroda, 1988a, b). In rabbit aorta, ISF-2405 inhibited the contractions induced by norepinephrine by decreasing $[Ca^{2+}]_i$ and Ca^{2+} sensitivity (Mitsui et al., 1990).

Trifluoperazine inhibited high K^+ -induced contraction accompanied by a decrease in $[Ca^{2+}]_i$ and inhibition of contractile elements in guinea pig ileal muscle strips (Hori et al., 1989b), suggesting that trifluoperazine inhibits not only calmodulin, but also Ca^{2+} influx stimulated by high K^+ .

8-(*N,N*-Diethylamino)octyl-3,4,5-trimethoxybenzoate (TMB-8) inhibited the high K^+ -induced contraction more strongly than the norepinephrine-induced contraction in rat aorta, although it strongly inhibited the increase in $[Ca^{2+}]_i$ elicited by both stimulants (Ishihara and Karaki, 1991). This result suggests that TMB-8 has a Ca^{2+} channel blocker-like action. At higher concentrations ($300 \mu M$), TMB-8 inhibited contractions induced by norepinephrine and caffeine by inhibiting Ca^{2+} release and decreasing Ca^{2+} sensitivity.

5-[3-([2-(3,4-Dimethoxyphenyl)-ethyl]amino)-1-oxopropyl]-2,3,4,5-tetrahydro-1,5-benzothiazepine fumarate (KT-362) inhibited contractions induced by high K^+ and norepinephrine accompanied by a decrease in $[Ca^{2+}]_i$, by inhibitory actions on Ca^{2+} influx and Ca^{2+} release, in rat aorta (Sakata and Karaki, 1991). KT-362

also inhibited the norepinephrine-induced increase in Ca^{2+} sensitivity.

1,9-Dideoxyforskolin showed effects similar to those of Ca^{2+} channel blockers in rat aorta (Abe and Karaki, 1992a). It inhibited contractions induced by high K^+ more strongly than those induced by norepinephrine, and it inhibited the increases in $[Ca^{2+}]_i$ and contraction elicited by high K^+ to a similar degree.

Reserpine inhibited the contraction and the increase in $^{45}Ca^{2+}$ influx elicited by high K^+ in rabbit ear artery (Casteels and Login, 1983). In rabbit aorta (Satoh et al., 1992), reserpine inhibited the high K^+ -induced contraction accompanied by a decrease in $[Ca^{2+}]_i$ without changing the Ca^{2+} sensitivity. These results suggest that reserpine has a Ca^{2+} channel blocker-like action.

Hydrogen peroxide augmented the increase in $[Ca^{2+}]_i$ induced by high K^+ or phenylephrine in rabbit aorta (Iesaki et al., 1996). However, hydrogen peroxide only slightly increased the high K^+ -induced contraction and inhibited the phenylephrine-induced contraction. Thus, hydrogen peroxide appears to inhibit the agonist-induced increase in Ca^{2+} sensitivity.

Spiradoline, a κ -opioid receptor agonist, inhibited high K^+ -induced contraction and decreased $[Ca^{2+}]_i$ in swine coronary artery (Harasawa et al., 1991). The inhibitory effects on high K^+ -induced contractions were stronger than on contractions elicited by prostaglandin $F_{2\alpha}$, suggesting that this relaxant has a Ca^{2+} channel blocker-like action.

Azelastin inhibited contractions induced by high K^+ , carbachol and endothelin-1 accompanied by a decrease in $[Ca^{2+}]_i$ by inhibiting both Ca^{2+} influx and Ca^{2+} release in swine trachea (Sanagi et al., 1992). Azelastin also directly inhibited the contractile elements in permeabilized smooth muscle.

8-*tert*-Butyl-6,7-dihydropyrrolo-[3,2-*e*]-5-methylpyrazolo-[1,5a]-pyrimidine-3-carbonitrile (LP-805) decreased $[Ca^{2+}]_i$ and tension during the contraction induced by high K^+ without changing Ca^{2+} sensitivity in rabbit femoral artery (Ushio-Fukai et al., 1994). LP-805 also inhibited the norepinephrine-induced increase in both $[Ca^{2+}]_i$ and force by opening K^+ channels. However, LP-805 did not inhibit the Ca^{2+} release elicited by norepinephrine. In rat aorta (Kishii et al., 1992), in contrast, LP-805 inhibited the Ca^{2+} release induced by norepinephrine and prostaglandin $F_{2\alpha}$.

Rutaecarpine increased $[Ca^{2+}]_i$ in endothelial cells and induced endothelium-dependent relaxation in rat aorta (Wang et al., 1996). Rutaecarpine also directly acted on smooth muscle and inhibited high K^+ -induced contraction by decreasing $[Ca^{2+}]_i$.

Lidocaine inhibited contractions induced by high K^+ or acetylcholine accompanied by a decrease in $[Ca^{2+}]_i$ by inhibiting both Ca^{2+} influx and Ca^{2+} release in swine trachea (Kai et al., 1993). Lidocaine also inhibited the increase in Ca^{2+} sensitivity elicited by acetylcholine.

Hirsutine, an indole alkaloid from *Uncaria rhyncho-phylla*, inhibited the contractions induced by high K^+ and norepinephrine by decreasing $[Ca^{2+}]_i$ in rat aorta (Horie et al., 1992). Hirsutine also inhibited the caffeine-induced contraction by inhibiting Ca^{2+} release.

2,3-Butanedione-2-monoxime inhibited the contractions induced by high K^+ and phenylephrine by inhibiting Ca^{2+} influx and decreasing $[Ca^{2+}]_i$ in guinea pig portal vein (Watanabe, 1993) and in guinea pig taenia coli (Osterman et al., 1993). 2,3-Butanedione-2-monoxime also inhibited the Ca^{2+} -induced contraction in permeabilized smooth muscle, suggesting direct inhibitory effect on the contractile elements (Osterman et al., 1993).

A minor tranquilizer, midazolam, inhibited contractions induced by high K^+ or carbachol accompanied by a decrease in $[Ca^{2+}]_i$ in swine trachea (Yoshimura et al., 1995). However, midazolam changed neither Ca^{2+} release nor Ca^{2+} sensitivity.

Trimebutine inhibited the contractions induced by high K^+ , carbachol and caffeine by decreasing $[Ca^{2+}]_i$ in guinea pig taenia coli (Nagasaki et al., 1991). However, trimebutine did not change the Ca^{2+} sensitivity of contractile elements.

The polyamines, putrescine, spermidine and spermine, inhibited the spontaneous contractions and 20 mM KCl-induced contractions accompanied by a decrease in $[Ca^{2+}]_i$, although contractions induced by 90 mM KCl was not inhibited in guinea pig taenia coli (Nilsson and Hellstrand, 1993).

Lithium ion inhibited contractions induced by high K^+ , carbachol and histamine without changing $[Ca^{2+}]_i$ in the guinea pig ileal longitudinal smooth muscle (Hori et al., 1989a, 1995). Lithium ion also had no effect on the increase in $^{45}Ca^{2+}$ uptake elicited by high K^+ . The high K^+ -induced transient increase in MLC phosphorylation was inhibited by lithium ion. In the permeabilized ileal strips, contraction induced by Ca^{2+} was inhibited by lithium ion. Lithium ion also inhibited the MLC phosphorylation. These results suggest that lithium ion directly inhibits MLC kinase in guinea pig ileum.

4. *Summary.* The effects of smooth muscle relaxants are summarized in table 2. Various relaxants inhibit smooth muscle contraction by two mechanisms: decrease in $[Ca^{2+}]_i$ and decrease in the Ca^{2+} sensitivity of contractile elements. Ca^{2+} channel blockers decrease $[Ca^{2+}]_i$ by inhibiting L-type Ca^{2+} channel. Although some relaxants including Ca^{2+} channel blockers selectively inhibit the L-type Ca^{2+} channel, other relaxants inhibit both $[Ca^{2+}]_i$ and Ca^{2+} sensitivity. Also, there are relaxants that inhibit Ca^{2+} sensitivity without decreasing $[Ca^{2+}]_i$. Compared to the effects of L-type Ca^{2+} channel blockers, agents that inhibit SR functions show smaller inhibitory effects on the contractions induced by high K^+ or receptor agonists (see section IV.B.), suggesting that SR Ca^{2+} is less important as a source of contractile Ca^{2+} .

E. Agents Affecting Endothelial Functions

1. *Calcium movements in vascular endothelium.* The $[Ca^{2+}]_i$ in vascular endothelium indirectly regulates vascular tone by activating Ca^{2+} -dependent enzymes such as nitric oxide synthase, phospholipase A_2 and lyso-platelet activating factor acetyltransferase, resulting in the production of nitric oxide, prostacyclin, and platelet activating factor (Suttorp et al., 1985, 1987; Ghigo et al., 1988; Luckhoff et al., 1988; Schmidt et al., 1989; Korenaga et al., 1993). Production of endothelium-derived hyperpolarizing factor is also Ca^{2+} -dependent (Chen and Suzuki, 1990). Endothelial $[Ca^{2+}]_i$ also modulates permeability of endothelium (Shasby and Shasby, 1986).

Agonists such as ATP, bradykinin, acetylcholine and endothelin-1 induce large and transient increases followed by small and sustained increases in $[Ca^{2+}]_i$ in the endothelial cells as measured with fluorescent Ca^{2+} indicators (Colden-Stanfield et al., 1987; Peach et al., 1987; Dantluri et al., 1988; Hallam and Pearson, 1986; Yokokawa et al., 1990; Shin et al., 1992). In rat aorta (Sato et al., 1990), carbachol increased $[Ca^{2+}]_i$ in the endothelium by Ca^{2+} release and Ca^{2+} influx and relaxed the muscle. Also, in rat aorta (Moritoki et al., 1994; Zheng et al., 1994), release of SR Ca^{2+} by thapsigargin and cyclopiazonic acid induced endothelium-dependent relaxation and cyclic GMP production, and these effects were inhibited by the inhibitors of nitric oxide synthase, a calmodulin inhibitor and removal of Ca^{2+} . In rat isolated mesenteric artery (Fukao et al., 1995), release of SR Ca^{2+} by thapsigargin and cyclopiazonic acid hyperpolarized the smooth muscle membrane which was unaffected by nitric oxide synthase inhibitor. In Ca^{2+} -free medium, neither thapsigargin nor cyclopiazonic acid elicited hyperpolarization. In muscles precontracted with phenylephrine, thapsigargin and cyclopiazonic acid produced endothelium-dependent relaxation. An inhibitor of nitric oxide synthase only partly inhibited the relaxation. These results indicate that increase in endothelial $[Ca^{2+}]_i$ elicits release of both nitric oxide and endothelium-derived hyperpolarizing factor.

a. *MECHANISMS OF CALCIUM RELEASE.* In endothelial IP_3 cells, various agonists elicit a transient production of IP_3 . The IP_3 production was not affected by Ca^{2+} channel blockers, Ca^{2+} chelators, inhibitors of Ca^{2+} release such as TMB-8, and depletion of Ca^{2+} stores by thapsigargin (Derian and Moskowitz, 1986; Iouzen et al., 1995). The agonist-induced Ca^{2+} release was inhibited by the phorbol ester-induced activation of C kinase, possibly by inhibiting phosphatidylinositol turnover (Voyno-Yasenetskaya et al., 1989; Kugiyama et al., 1992). Some investigators suggested that CICR does not exist in vascular endothelium since modulators of CICR, such as caffeine, ryanodine and cyclic ADP ribose, changed neither the resting $[Ca^{2+}]_i$ nor the increase in $[Ca^{2+}]_i$ induced by receptor-agonist (Freay et al., 1989;

Schilling and Elliott, 1992; Amano et al., 1994). However, others suggested the existence of CICR because caffeine and ryanodine increased resting $[Ca^{2+}]_i$ or inhibited the increase in $[Ca^{2+}]_i$ induced by receptor-agonist (Graier et al., 1994; Rusko et al., 1995 a, b; Wang et al., 1995; Ullmer et al., 1996). Experiments with antibody also indicated the existence of ryanodine receptors in the endothelium of guinea pig aorta and heart (Lesh et al., 1992). In the electrophysiological studies, it was reported that ryanodine inhibited the hyperpolarization induced by caffeine but not by acetylcholine in the endothelial cells of guinea pig aorta, suggesting that Ca^{2+} stores sensitive to caffeine and to acetylcholine are different (Chen and Cheung, 1993).

b. MECHANISMS OF CALCIUM INFLUX. Ionic channels in vascular endothelial cells have been reviewed by Adams (1994). Resting Ca^{2+} influx in endothelial cells was inhibited by La^{3+} or Ni^{2+} but not by the L-type Ca^{2+} channel blockers. Increased external pH accelerated Ca^{2+} influx which may contribute to the basal release of nitric oxide and prostacyclin (Demirel et al., 1993; Nilius et al., 1993).

Voltage-dependent Ca^{2+} channels do not seem to exist in endothelial cells since high K^+ did not increase $[Ca^{2+}]_i$, Ca^{2+} channel blockers such as verapamil and 1,4-dihydropyridines did not inhibit the agonist-induced increase in $[Ca^{2+}]_i$, and the voltage-activated Ca^{2+} current was not observed (Colden-Stanfield et al., 1987; Takeda et al., 1987; Amano et al., 1994). In microvascular endothelium, however, electrophysiological studies indicated the existence of the T- or L-type voltage-dependent Ca^{2+} channels (Bossu et al., 1989, 1992a, b). There may be regional differences in the distribution of voltage-dependent Ca^{2+} channels in the endothelium.

The Ca^{2+} influx stimulated by agonists was inhibited by the inorganic Ca^{2+} channel blockers such as La^{3+} and Ni^{2+} , a putative inhibitor of nonselective cation channel, 1-[3-(4-methoxyphenyl) propoxy]-1-(4-methoxyphenyl)ethyl-1*H*-imidazole HCl (SKF 96365) (Merritt et al., 1990), and an anti-inflammatory agent, mefenamic acid, but not by the L-type Ca^{2+} channel blockers such as the 1,4-dihydropyridines (Schilling and Elliott, 1992; Schilling et al., 1992; Nilius et al., 1993; Weber et al., 1993; Amano et al., 1994). Calcium influx was also inhibited by membrane depolarization, decreases in external Cl^- concentration, Cl^- channel blockers, activation of C kinase, and a phosphatase inhibitor, calyculin A (Ryan et al., 1988; Jacob, 1990; Hosoki and Iijima, 1994; Yumoto et al., 1995; Amano et al., 1997). In contrast, Ca^{2+} influx was enhanced by alkaline pH (Schilling et al., 1992). Activation of A kinase enhanced Ca^{2+} influx in some, but not all of the preparations (Hallam et al., 1989; Buchan and Martin, 1992; Graier et al., 1993; Amano et al., 1997). In contrast, activation of G kinase had no effect (Ryan et al., 1988; Buchan and Martin, 1992; Amano et al., 1997). The permeability of these channels was more selective to monovalent cations than

to divalent cations ($Na^+ = K^+ > Ca^{2+} = Ba^{2+} = Mn^{2+}$) (Nilius et al., 1993). Once this pathway was activated, increased influx of Ca^{2+} or Mn^{2+} continued even after removal of agonist, suggesting that receptor activation does not directly activate the Ca^{2+} channel (Hallam et al., 1989; Jacob, 1990).

CRAC was inhibited by such inhibitors of the receptor-operated nonselective cation channel as La^{3+} , Ni^{2+} , SKF 96365, mefenamic acid, membrane depolarization, decreases in the external Cl^- concentration, Cl^- channel blockers, an activation of C kinase and a phosphatase inhibitors, but not by L-type Ca^{2+} channel blockers or activation of G kinase (Schilling et al., 1992; Gericke et al., 1994; Hosoki and Iijima, 1995; Yamamoto et al., 1995). Calcium influx through this pathway was enhanced by external alkaline pH (Schilling et al., 1992). The permeability of this pathway was more selective to monovalent cations than to divalent cations ($Na^+ = K^+ > Ca^{2+} = Ba^{2+} = Mn^{2+}$) (Nilius et al., 1993). Pharmacological and electrophysiological evidences indicate that the influx pathway activated by receptor agonist is indistinguishable from CRAC (Schilling et al., 1992; Thuringer and Sauve, 1992; Vaca and Kunze, 1994, 1995) and others suggested that these two pathways are different because of differences in the permeability to Mn^{2+} and the sensitivity to SKF 96365 (Li and Van Breemen, 1996). Inhibitors of tyrosine kinase inhibited CRAC. Fleming et al. (1995) suggested that tyrosine phosphorylation of two cytoskeletal proteins (85- and 100-kDa) mirrors the filling state of the intracellular Ca^{2+} stores and that they play a central role in the regulation of CRAC.

It has been suggested that a Ca^{2+} influx factor is produced after depletion of the Ca^{2+} stores (Randriamampita and Tsien, 1993). Degradation of the Ca^{2+} influx factor was inhibited by cyclosporine A or chelation of external Ca^{2+} by EGTA (Randriamampita and Tsien, 1995). Since the nonselective inhibitors of phosphatases, calyculin-A and tautomycin, inhibited CRAC, whereas the inhibitor of the type 2 phosphatase, okadaic acid, was without effect, it appeared likely that the type 1 phosphatase activates the Ca^{2+} influx factor (Wong et al., 1995). Since the inhibitors of cytochrome P_{450} inhibited CRAC, Graier et al. (1995) suggested that depletion of Ca^{2+} stores activates the microsomal P_{450} mono-oxygenase which, in turn, synthesized 5,6-epoxyeicosatrienoic acid, and that this or one of the metabolites of arachidonic acid is a second messenger for activation of CRAC. On the other hand, Randriamampita and Tsien (1993) suggested that metabolite of arachidonic acid was not the mediator of CRAC since the inhibitors of phospholipase A_2 , cyclooxygenase and cytochrome P_{450} did not prevent Jurkat cells from releasing a Ca^{2+} influx factor. It was reported that the molecular weight of the Ca^{2+} influx factor was about 500–600 Da (Randriamampita and Tsien, 1993; Kim et al., 1995b). Kim et al. (1995b) reported that the authentic Ca^{2+} influx fac-

tor was resolved from the extract of Jurkat cells stimulated with thapsigargin by using HPLC. Its R_f value was 0.57. It induced a Ca^{2+} -dependent Cl^- current only when injected into the intracellular space, and this current was inhibited by removal of external Ca^{2+} or addition of Ni^{2+} . It was also reported that a small GTP-binding protein was the diffusible messenger in CRAC since GDP β S or GTP γ S inhibited the Ca^{2+} entry (Bird and Putney, 1993; Fasolato et al., 1993). On the other hand, Petersen and Berridge (1996) removed cytoplasm from the thapsigargin-treated *Xenopus* oocyte and injected it after extraction with HCl into another oocyte. However, the extract did not activate Ca^{2+} entry. From these results, they suggested that CRAC is co-localized with Ca^{2+} release channels.

Although endothelial cells possess a $\text{Na}^+/\text{Ca}^{2+}$ exchange mechanism (Sage et al., 1991; Li and Van Breemen, 1995), and although a putative inhibitor of this mechanism, dichlorovenezamil, inhibited the endothelium-derived relaxation of vascular smooth muscle (Winquist et al., 1985), evidence suggests that this mechanism does not play an important role in either the modulation of resting $[\text{Ca}^{2+}]_i$ or the receptor-mediated increase in $[\text{Ca}^{2+}]_i$ in vascular endothelium (Sage et al., 1991).

2. Effects of fluid shear stress. Vascular endothelial cells are always exposed to blood flow. Changes in blood flow modulate endothelial functions such as production of nitric oxide and prostacyclin. Shear stress increases endothelial $[\text{Ca}^{2+}]_i$. Continuous mechanical stimulation such as changes in perfusion rate or osmolarity released Ca^{2+} from stores and increased Ca^{2+} influx (Dull and Davies, 1991; Geiger et al., 1992; Falcone, 1995). On the other hand, short-term stimulation induced by flashing of solution or mechanical stimulation of cells with micropipets induced Ca^{2+} influx without Ca^{2+} release (Schwarz et al., 1992; Demer et al., 1993; Naruse and Sokabe, 1993; Sigurdson et al., 1993). It was suggested that the cascade of actin/actin-binding protein/phospholipase A_2 /arachidonic acid or GTP-binding protein/phospholipase C/phosphatidylinositol turnover is involved in the Ca^{2+} release induced by continuous mechanical stimulation (Oike et al., 1994). It is not evident if mechanical stimulation releases Ca^{2+} from the same stores as those activated by agonists. Since the Ca^{2+} influx pathway activated by a short-term mechanical stimulation is more permeable to divalent cations than to monovalent cations (Nilius et al., 1993), this pathway may be different from the receptor-operated nonselective cation channel or CRAC.

In bovine aortic endothelial cells (Kanai et al., 1995), synthesis of nitric oxide elicited by shear stress, but not by ATP, was dependent on extracellular Ca^{2+} . In bovine femoral artery endothelium (Hecker et al., 1993; Ayajiki et al., 1996), in contrast, production of nitric oxide induced by acetylcholine, but not by shear stress, was dependent on extracellular Ca^{2+} . Corson et al. (1996)

reported that shear stress increased nitric oxide production more strongly than $[\text{Ca}^{2+}]_i$ increase elicited by ionomycin. Using a flow-step protocol, they also found that $[\text{Ca}^{2+}]_i$ increased on the onset of shear stress, but not after a step increase. However, the step increase in shear stress was associated with a potent biphasic increase in the nitric oxide production rate and phosphorylation of nitric oxide synthase. From these results they suggested that shear stress phosphorylates and activates NOS in the absence of $[\text{Ca}^{2+}]_i$ increase. Production of nitric oxide in endothelial cells may be regulated by both Ca^{2+} -dependent and -independent mechanisms.

3. Relaxant effect of nitric oxide. Characteristics of the nitric oxide-induced smooth muscle relaxation have been reviewed by Moncada et al. (1991), Stark and Szurszewski (1992), Sanders and Ward (1992), Lincoln et al. (1996) and Toda and Okamura (1996). Sato et al. (1990) measured $[\text{Ca}^{2+}]_i$ in both endothelium and smooth muscle simultaneously with smooth muscle contraction in rat aorta. They found that release of nitric oxide elicited by carbachol strongly relaxed the norepinephrine-stimulated aorta with an increase in endothelial $[\text{Ca}^{2+}]_i$, and positive correlation was obtained between the increase in endothelial $[\text{Ca}^{2+}]_i$ and relaxation. However, carbachol-induced relaxation was accompanied by only a small decrease in smooth muscle $[\text{Ca}^{2+}]_i$. The effects of nitric oxide on smooth muscle $[\text{Ca}^{2+}]_i$ and contraction are similar to those of sodium nitroprusside (Karaki et al., 1988b), suggest that nitric oxide may decrease $[\text{Ca}^{2+}]_i$ in the smooth muscle cells and also decrease Ca^{2+} sensitivity of contractile elements, resulting in vasodilatation. Han et al. (1995b) reported that insulin released nitric oxide and relaxed contraction in rat aorta by mechanisms similar to those of carbachol. In porcine coronary artery (Hirano and Kanaide, 1993; Kuroiwa et al., 1995) bradykinin increased endothelial $[\text{Ca}^{2+}]_i$, and decreased both smooth muscle $[\text{Ca}^{2+}]_i$ and force to resting levels, during prostaglandin $\text{F}_{2\alpha}$ - or U46619-induced contractions, only when endothelium was intact. During high K^+ depolarization, bradykinin induced a greater relaxation than that expected from the reduction in $[\text{Ca}^{2+}]_i$, suggesting that nitric oxide relaxes porcine coronary artery by the mechanisms similar to those in rat aorta. Shin et al. (1996) also showed that ATP increased $[\text{Ca}^{2+}]_i$ in vascular endothelial cells and decreased $[\text{Ca}^{2+}]_i$ of adjacently cocultured vascular smooth muscle cells. The $[\text{Ca}^{2+}]_i$ reduction in cocultured smooth muscle with endothelium by ATP was attenuated by the nitric oxide synthase inhibitors, whereas these inhibitor potentiated the $[\text{Ca}^{2+}]_i$ elevation in the endothelial cells, suggesting that nitric oxide affects smooth muscle cells in a paracrine manner while endothelial cells in an autocrine fashion. In arterioles isolated from rat cortex (Dietrich et al., 1994), inhibition of nitric oxide production by N^ω -nitro-L-arginine induced vasoconstriction without increasing $[\text{Ca}^{2+}]_i$. This result suggests that nitric oxide inhibits contraction without

tion, since opening of the nonselective cation channel depolarizes the membrane, the L-type Ca^{2+} channel is activated to further increase Ca^{2+} influx. Depletion of SR Ca^{2+} also depolarizes the membrane by inhibiting the Ca^{2+} -activated K^+ channels. The fourth mechanism is activation of the non-L-type Ca^{2+} entry resulting from release of SR Ca^{2+} (CRAC). All of these mechanisms, composing the receptor-mediated Ca^{2+} mobilizing pathway in fig. 8, increase $[\text{Ca}^{2+}]_i$ in both the contractile and noncontractile compartments. The fifth mechanism is to increase Ca^{2+} sensitivity of contractile elements which increases contractile force at a given $[\text{Ca}^{2+}]_i$. This mechanism is mediated by the balance between phosphorylation and dephosphorylation of functional proteins including the endogenous modulators of the MLC phosphatase. This mechanism belongs to the receptor-mediated metabotropic pathway in fig. 8.

Since the major mechanism of agonist-induced Ca^{2+} influx is the opening of the L-type Ca^{2+} channels and only a small portion of Ca^{2+} influx is due to opening of nonselective cation channel and CRAC, the agonist-induced sustained increase in $[\text{Ca}^{2+}]_i$ is strongly inhibited by Ca^{2+} channel blockers but not by the inhibitors of SR functions. However, the agonist-induced sustained contraction is only weakly inhibited. This is because Ca^{2+} channel blockers do not inhibit the agonist-induced increase in Ca^{2+} sensitivity which can maintain a large contraction even in the presence of a small increase in $[\text{Ca}^{2+}]_i$. In contrast, the initial transient increase in $[\text{Ca}^{2+}]_i$, which is due to Ca^{2+} release, is inhibited by the inhibitors of SR functions but not by the Ca^{2+} channel blockers.

Calcium ion in the noncontractile compartment activates various mechanisms in the plasmalemma including K^+ channels, $\text{Na}^+/\text{Ca}^{2+}$ exchanger and Ca^{2+} pump. Membrane hyperpolarization elicited by the activation of K^+ channel may inhibit the receptor-mediated signal transduction pathways. Activation of $\text{Na}^+/\text{Ca}^{2+}$ exchanger and Ca^{2+} pump decreases Ca^{2+} in this compartment and also Ca^{2+} in the SR. Thus, an increase in Ca^{2+} in this compartment may serve as the negative feedback pathway for regulation of contraction in fig. 8. Furthermore, the receptor-mediated increase in diacylglycerol activates C kinase, which may also acts as a negative feedback pathway by inhibiting the receptor-mediated signal transduction.

An important question is whether all of these mechanisms are simultaneously operating in smooth muscle tissue. In rat aorta (Karaki et al., 1991) and tail artery (Chen and Rembold, 1995), it has been shown that stimulation of the α -adrenoceptors induced Ca^{2+} release, increased Ca^{2+} influx though both the Ca^{2+} channel blocker-sensitive and -insensitive pathways, and increased Ca^{2+} sensitivity of contractile elements. These results indicate that in some types of vascular smooth muscle, all of these mechanisms are playing an important role. However, some receptors such as the α_{2A} -

adrenoceptors and the endothelin ET_B receptors are not coupled to Ca^{2+} release. Furthermore, Ca^{2+} sensitivity is not increased by agonists in other types of smooth muscle, such as chicken gizzard (Anabuki et al., 1994), rat anococcygeus muscle (Shimizu et al., 1995), and rat uterus (Sakata and Karaki, 1992).

When stimulant is removed, the Ca^{2+} channel and the nonselective cation channel are closed. Increased Ca^{2+} influx returns to a resting level and increased $[\text{Ca}^{2+}]_i$ is decreased by the plasmalemmal Ca^{2+} pump, the SR Ca^{2+} pump and $\text{Na}^+/\text{Ca}^{2+}$ exchange. Calcium ion in the SR may be unloaded through Ca^{2+} release coupled to the $\text{Na}^+/\text{Ca}^{2+}$ exchange. The relative importance of these mechanisms to decrease $[\text{Ca}^{2+}]_i$ in different tissues remains to be examined.

B. Receptor-Effector-Structure Interrelationship

The α_1 -adrenoceptors in rat aorta and rabbit mesenteric artery are coupled to $\text{IP}_3/\text{Ca}^{2+}$ release system (Hashimoto et al., 1986; Pijuan and Litosch, 1988; Pijuan et al., 1993). However, this receptor is not coupled to Ca^{2+} release in ferret aorta and rat anococcygeus muscle, and only weakly coupled to Ca^{2+} release in rat tail artery (see section IV.C.2.). This receptor is coupled also to the L-type Ca^{2+} channel in rat portal vein, rabbit ear artery and rabbit mesenteric artery whereas these are coupled to nonselective cation channels in rabbit portal vein and ear artery. The muscarinic receptors are coupled to both Ca^{2+} influx and Ca^{2+} release although Ca^{2+} release is activated only by high concentrations of carbachol in the longitudinal smooth muscle of guinea pig ileum (Wang et al., 1992). The muscarinic agonists, pilocarpine and oxytremorin, increase Ca^{2+} influx but not Ca^{2+} release. The endothelin ET_B receptors in vascular endothelium are coupled to the $\text{IP}_3/\text{Ca}^{2+}$ release system (Sudjarwo et al., 1992), whereas those in swine pulmonary vein are not (Sudjarwo et al., 1995). Thus, some receptors may be coupled only to the $\text{IP}_3/\text{Ca}^{2+}$ release system, whereas other receptors are coupled only to the L-type Ca^{2+} channels or to the nonselective cation channels. Some cells may have receptors coupled to ion channels but not those coupled to Ca^{2+} release, whereas other cells may have both types of receptors.

Both Ca^{2+} release and Ca^{2+} influx usually supply Ca^{2+} to the contractile compartment and elicit contraction. However, Ca^{2+} mobilization due to some receptor agonists does not elicit contraction in some types of smooth muscles because Ca^{2+} is supplied mainly to the noncontractile compartment (see section II.E.1.). These observations suggest a specific linkage among receptor, effector (ion channels in plasmalemma or the SR) and Ca^{2+} compartment (contractile or noncontractile).

Among the three cytoplasmic spaces suggested by Van Breemen and co-workers (see Van Breemen et al., 1995), the central cytoplasmic space may correspond to the contractile Ca^{2+} compartment, whereas the junctional space may be the pathway of Ca^{2+} from membrane ion

channels to the central cytoplasmic space (fig. 5). Furthermore, the junctional space may correspond to the noncontractile Ca^{2+} compartment. Function of the junctional space may be to remove Ca^{2+} from the SR. Calcium ion released from the SR by IICR may increase $[\text{Ca}^{2+}]_i$ in this space and activate the $\text{Na}^+/\text{Ca}^{2+}$ exchanger to exclude Ca^{2+} (fig. 5). High concentrations of Ca^{2+} may also activate various Ca^{2+} -dependent mechanisms including CICR, K^+ channel, nonselective cation channel, Cl^- channel, C kinase, and phospholipase C (Van Breemen et al., 1995). Inhibition of SR function by inhibiting the SR Ca^{2+} pump using cyclopiazonic acid or thapsigargin or by opening the Ca^{2+} release channels using ryanodine inhibited this mechanism (see Van Breemen et al., 1995, Bolton and Imaizumi, 1996). In contrast, the noncontractile Ca^{2+} compartment has different characteristics from those of the junctional space. Inhibition of SR Ca^{2+} pump by cyclopiazonic acid increased $[\text{Ca}^{2+}]_i$ in this compartment, suggesting that Ca^{2+} in this compartment is taken up by the SR. Furthermore, opening of the SR Ca^{2+} channels by ryanodine did not change $[\text{Ca}^{2+}]_i$ in this compartment, suggesting that the SR Ca^{2+} release does not contribute to increase

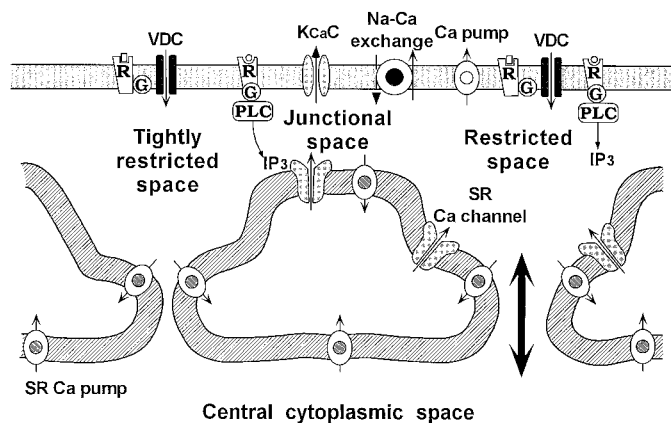

FIG. 9. The receptor-effector-structure interrelationship in smooth muscle. There are four spaces in the cell: junctional space, restricted space, tightly restricted space, and central cytoplasmic space. Junctional space, restricted space and central cytoplasmic space are similar to those suggested by Van Breemen et al. (1995) in figure 5. Tightly restricted space is isolated from central cytoplasm in such a manner that neither aequorin nor Ca^{2+} freely diffuse between these two spaces. In rat aorta, the α -adrenoceptor/ IP_3 system, the α -adrenoceptor/ Ca^{2+} channel system, the endothelin ET_A receptor/ Ca^{2+} channel system, and the prostaglandin $\text{F}_{2\alpha}/\text{Ca}^{2+}$ channel system exist facing the restricted space. Activation of these systems increases $[\text{Ca}^{2+}]_i$ in this space. Ca^{2+} in this space diffuses relatively freely to the central cytoplasmic space and elicits contraction, although a part of Ca^{2+} is taken up by the SR. The ET_A receptor/ IP_3 system, the prostaglandin $\text{F}_{2\alpha}$ receptor/ IP_3 system, and the purinergic receptor/ Ca^{2+} channel system are located in the membrane facing the tightly restricted space. Activation of these systems increases $[\text{Ca}^{2+}]_i$ in this space. Ca^{2+} in this space does not easily diffuse to the central cytoplasmic space. Ca^{2+} in this space is taken up by the SR through a cyclopiazonic acid-sensitive SR Ca^{2+} pump. Ca^{2+} in the SR may be unloaded by vectorial Ca^{2+} release at the junctional space (see fig. 5).

$[\text{Ca}^{2+}]_i$ in this compartment. This compartment is supplied with Ca^{2+} mainly by Ca^{2+} influx (Abe et al., 1995, 1996; Karaki et al., 1996). Thus, the noncontractile Ca^{2+} compartment may be different from the junctional space. From these results, we suggest the existence of a tightly restricted space (fig. 9). This space is separated from the central cytoplasm in such a manner that not only a large molecules such as aequorin cannot easily diffuse between these two spaces. Calcium ion in this space cannot reach the central cytoplasm because of diffusion barrier and also by SR Ca^{2+} pump. Communication between these two spaces may be tighter in ferret portal vein (Abe et al., 1995) than in swine carotid artery (Rembold and Murphy, 1988b), because it took 13 h and 2.5 h, respectively, for the supply of aequorin from the central cytoplasm to move into the tightly restricted space. Changes in $[\text{Ca}^{2+}]_i$ in this space are detected by aequorin but not by fura-2 because, although $[\text{Ca}^{2+}]_i$ in this space is much higher than in the central cytoplasm, the size of this space is small. In some smooth muscle like rat urinary bladder (Munro and Wendt, 1994) and bovine trachea (Tajimi et al., 1995); however, the size of this space may be larger than that in ferret portal vein because even fura-2 can detect the increase in $[\text{Ca}^{2+}]_i$ in this space.

The specific coupling between receptor and effector (either Ca^{2+} influx pathway or Ca^{2+} release channels) may be based upon the specific location of the plasmalemma. In rat aorta, the endothelin ET_A receptor/ IP_3 system or the prostaglandin $\text{F}_{2\alpha}$ receptor/ IP_3 system may be located in the membrane facing the tightly restricted space. Since Ca^{2+} influx through the nonselective cation channel or CRAC is not coupled to contraction, these mechanisms may also supply Ca^{2+} to this space in rat aorta. Even a part of the Ca^{2+} entering through the L-type Ca^{2+} channel, activated by either norepinephrine or high K^+ , may be trapped in this space. Calcium ion in this space may regulate various Ca^{2+} -dependent mechanisms in the plasmalemma independently of contraction.

In contrast to prostaglandin $\text{F}_{2\alpha}$ and endothelin-1, Ca^{2+} release induced by norepinephrine elicits contraction in rat aorta. Furthermore, Ca^{2+} influx elicited by the opening of the L-type Ca^{2+} channel, either by membrane depolarization or by receptor activation, also elicits contraction. Thus, a larger part of the α -adrenoceptor/ IP_3 systems and the L-type Ca^{2+} channels may be faced to the restricted space. Although a portion of Ca^{2+} entering the cell or released from the SR toward this space is trapped by the SR, a larger portion will reach the central cytoplasm and elicit contraction.

Combinations of receptor, effector, and structure may be different depending upon the specific types of tissues. Thus, endothelin-1-induced Ca^{2+} release, ATP-induced Ca^{2+} influx and other Ca^{2+} -mobilizing mechanisms are coupled to contraction to varying degrees in different types of smooth muscle.

VI. Conclusions

- Contractions of smooth muscle are regulated mainly by the changes in $[Ca^{2+}]_i$. Receptor is coupled to a Ca^{2+} mobilizing pathway to increase $[Ca^{2+}]_i$ mainly by opening of the L-type Ca^{2+} channels and partly by release of Ca^{2+} from the SR. Opening of nonselective cation channels and CRAC may also increase $[Ca^{2+}]_i$.
- Calcium ion distributes unevenly in cytoplasm. There are at least two Ca^{2+} compartments in the cell: the contractile and noncontractile compartments. The contractile compartment represents the central cytoplasm where contractile elements exist. Calcium ion in this compartment activates MLC kinase, phosphorylates MLC, and induces contraction. An increase in Ca^{2+} in this compartment may elicit a concomitant increase in mitochondrial $[Ca^{2+}]_i$ to stimulate ATP production before it is triggered by the energy-consumption by contractile elements.
- Receptors are also coupled to a metabotropic pathway which activates C kinase and/or tyrosine kinase. These kinases inhibit MLC phosphatase and augment both MLC phosphorylation and contraction at a given $[Ca^{2+}]_i$ (the receptor-mediated increase in Ca^{2+} sensitivity). Arachidonic acid, liberated from the membrane by the activation of phospholipase A_2 , may also inhibit MLC phosphatase. The metabotropic pathway may also activate the actin-linked regulatory mechanism to induce contraction without changing the MLC phosphorylation.
- Cyclic AMP and cyclic GMP have the effects opposite to those of receptor agonists; to decrease $[Ca^{2+}]_i$ and to activate MLC phosphatase. The latter effect results in the decreases in both MLC phosphorylation and contraction at a given $[Ca^{2+}]_i$ (Ca^{2+} desensitization of MLC phosphorylation). Furthermore, these relaxants dissociate contraction from MLC phosphorylation by a mechanism yet to be examined. These relaxants also inhibit the effects of agonists to increase Ca^{2+} sensitivity either by inhibiting the receptor-mediated signal transduction or by activating MLC phosphatase.
- The noncontractile Ca^{2+} compartment may represent a small space between plasmalemma and the SR. The major role of Ca^{2+} in the noncontractile compartment may be to serve as a negative feedback pathway. Calcium ion in this compartment activates K^+ channels, hyperpolarizes the membrane and inhibits the receptor-mediated signal transduction. Diffusion of Ca^{2+} between the contractile and noncontractile compartments may be restricted by the SR and other organelles. Calcium concentrations in these compartments may be reg-

ulated separately and independently.

- In some types of smooth muscle, the agonist-induced release of Ca^{2+} increased $[Ca^{2+}]_i$ only in the noncontractile compartment, whereas Ca^{2+} influx elicited by the same agonist increased $[Ca^{2+}]_i$ in the contractile compartment. In contrast, Ca^{2+} release induced by other agonist increased $[Ca^{2+}]_i$ in the contractile compartment in the same muscle. These differences may be explained by specific interrelationships between receptor, effector (Ca^{2+} influx and Ca^{2+} release mechanisms) and the subplasmalemmal structures (contractile and noncontractile compartment) in different cell types.

Acknowledgements. We are grateful to Drs. Norimoto Urakawa (University of Tokyo), George B. Weiss (M. Hurley & Associates, Inc.), Kristine Kamm (University of Texas), Katherine Luby-Phelps (University of Texas), Cornelis Van Breemen (University of British Columbia), Yuji Imaizumu (Nagoya City University), Seiichi Komori (Gifu University), Satoko Takizawa, Masahito Okunishi and Tomomi Shibui (our department) for their help and suggestions. This work was supported by Grant-in-Aid for Scientific research from the Ministry of Education, Science, Sports and Culture, Japan.

REFERENCES

- AARONSON, P., AND BENHAM, C. D.: Alteration in $[Ca^{2+}]_i$ mediated by sodium-calcium exchange in smooth muscle cells isolated from the guinea-pig ureter. *J. Physiol. (Lond.)* **416**: 1–18, 1989.
- AARONSON, P., AND VAN BREEMEN, C.: Effects of sodium gradient manipulation upon cellular calcium, ^{45}Ca fluxes and cellular sodium in the guinea-pig taenia coli. *J. Physiol. (Lond.)* **319**: 443–461, 1981.
- ABDEL-LATIF, A. A.: Calcium-mobilizing receptors, polyphosphoinositides and the generation of second messengers. *Pharmacol. Rev.* **38**: 227–272, 1986.
- ABDEL-LATIF, A. A.: Biochemical and functional interactions between the inositol 1,4,5-trisphosphate: Ca^{2+} and cyclic AMP signaling systems in smooth muscle. *Cell. Signalling* **5**: 371–385, 1991.
- ABE, A., AND KARAKI, H.: Effects of forskolin on cytosolic Ca^{2+} level and contraction in vascular smooth muscle. *J. Pharmacol. Exp. Ther.* **249**: 895–900, 1989.
- ABE, A., AND KARAKI, H.: Calcium channel blocker-like action of 1,9-dideoxy-forskolin in vascular smooth muscle. *Jpn. J. Pharmacol.* **60**: 389–392, 1992a.
- ABE, A., AND KARAKI, H.: Mechanisms underlying the inhibitory effect of dibutyryl cyclic AMP in vascular smooth muscle. *Eur. J. Pharmacol.* **211**: 305–311, 1992b.
- ABE, A., AND KARAKI, H.: Synergistic effects of cyclic AMP-related vasodilators and phosphatase inhibitor okadaic acid. *Jpn. J. Pharmacol.* **63**: 129–131, 1993.
- ABE, F., KARAKI, H., AND ENDOH, M.: Effects of cyclopiazonic acid and ryanodine on cytosolic calcium and contraction in vascular smooth muscle. *Br. J. Pharmacol.* **118**: 1711–1716, 1996.
- ABE, F., MITSUI, M., KARAKI, H., AND ENDOH, M.: Calcium compartments in vascular smooth muscle cells as detected by aequorin signal. *Br. J. Pharmacol.* **116**: 3000–3004, 1995.
- ABE, S., NISHIMURA, J., NAKAMURA, M., AND KANAIDE, H.: Effects of nicorandil on cytosolic calcium concentrations and on tension development in the rabbit femoral artery. *J. Pharmacol. Exp. Ther.* **268**: 762–771, 1994.
- ABEBE, W., AND AGRAWAL, D. K.: Role of tyrosine kinases in norepinephrine-induced contraction of vascular smooth muscle. *J. Cardiovasc. Pharmacol.* **26**: 153–159, 1995.
- ADAM, L. P.: Mitogen-activated protein kinase. In *Biochemistry of Smooth Muscle Contraction*, ed. by M. Barany, pp. 167–177, Academic Press, New York, 1996.
- ADAM, L. P., GAPINSKI, P. C. J., AND HATHAWAY, D. R.: Phosphorylation sequences in h-caldesmon from phorbol ester-stimulated canine aortas. *FEBS Lett.* **302**: 223–226, 1992.
- ADAM, L. P., HAEBERLE, J. R., AND HATHAWAY, D. R.: Phosphorylation of caldesmon in arterial smooth muscle. *J. Biol. Chem.* **264**: 7698–7703, 1989.
- ADAM, L. P., HAEBERLE, J. R., AND HATHAWAY, D. R.: Caldesmon is not phosphorylated during contractions of porcine carotid arteries. *Am. J. Physiol.* **268**: C903–C909, 1995.
- ADAMS, D. J.: Ionic channels in vascular endothelial cells. *Trends Cardiovasc. Med.* **4**: 18–26, 1994.
- ADELSTEIN, R. S., CONTI, M. A., AND HATHAWAY, D. R.: Phosphorylation of smooth muscle myosin light chain kinase by the catalytic subunit of adenosine 3':5'-monophosphate-dependent protein kinase. *J. Biol. Chem.* **253**: 8347–8350, 1978.

- AHN, H. Y., KANG, S. E., CHANG, K. C., AND KARAKI, H.: Dibutyl cyclic AMP and forskolin inhibit phosphatidylinositol hydrolysis, Ca^{2+} influx and contraction in vascular smooth muscle. *Jpn. J. Pharmacol.* **59**: 263–265, 1992.
- AHN, H. Y., KARAKI, H., AND URAKAWA, N.: Inhibitory effects of caffeine on contractions and calcium movement in vascular and intestinal smooth muscle. *Br. J. Pharmacol.* **93**: 267–274, 1988.
- ALEXANDER, R. W., BROCK, T. A., GIMBRONE, M. A., JR., AND RITTENHOUSE, S. E.: Angiotensin increases inositol trisphosphate and calcium in vascular smooth muscle. *Hypertension* **7**: 447–451, 1985.
- ALI, S., BECKER, M. W., DAVIS, M. G., AND DORN, G. W.: Dissociation of vasoconstrictor-stimulated basic fibroblast growth factor expression from hypertrophic growth in cultured vascular smooth muscle cells: relevant roles of protein kinase C. *Circ. Res.* **75**: 836–843, 1994.
- AMANO, K., HORI, M., OZAKI, H., AND KARAKI, H.: Ca^{++} mobilization mediated by endothelin ET_A receptor in endothelium of rabbit aortic valve. *J. Pharmacol. Exp. Ther.* **271**: 1359–1364, 1994.
- AMANO, K., SATO, K., HORI, M., OZAKI, H., AND KARAKI, H.: Palytoxin-induced increase in endothelial Ca^{2+} in the rabbit aortic valve. *Naunyn-Schmiedeberg's Arch. Pharmacol.*, in press, 1997.
- AMARA, S. G., JONAS, V., JA, O. N., VALE, W., RIVIER, J., ROOS, B. A., EVANS, R. M., AND ROSENFELD, M. G.: Calcitonin COOH-terminal cleavage peptide as a model for identification of novel neuropeptides predicted by recombinant DNA analysis. *J. Biol. Chem.* **257**: 2129–2132, 1982.
- AMRANI, Y., MAGNIER, C., ENOUF, J., WUYTACK, F., AND BRONNER, C.: Ca^{2+} increase and Ca^{2+} -influx in human tracheal smooth muscle cells: role of Ca^{2+} pools controlled by sarco-endoplasmic reticulum Ca^{2+} -ATPase 2 isoform. *Br. J. Pharmacol.* **115**: 1204–1210, 1995a.
- AMRANI, Y., MARTINET, N., AND BRONNER, C.: Potentiation by tumor necrosis factor- α of calcium signals induced by bradykinin and carbachol in human tracheal smooth muscle cells. *Br. J. Pharmacol.* **114**: 4–5, 1995b.
- ANABUKI, J., HORI, M., OZAKI, H., KATO, I., AND KARAKI, H.: Mechanisms of pinacidil-induced vasodilatation. *Eur. J. Pharmacol.* **190**: 373–379, 1990.
- ANABUKI, J., OZAKI, H., AND KARAKI, H.: Change in cytosolic Ca^{2+} level and contractile force stimulated by high K^+ and carbachol in chicken gizzard smooth muscle (abstract). *Jpn. J. Pharmacol.* **64**(suppl. 1): 217P, 1994.
- ANDRIANTSIHOAINA, R., LAGAUD, G. J., ANDRE, L. A., MULLER, B., AND STOCLET, J. C.: Effects of cGMP on calcium handling in ATP-stimulated rat resistance arteries. *Am. J. Physiol.* **268**: H1223–H1231, 1995.
- AOKI, S., AND ITO, K.: Time- and use-dependent inhibition by ryanodine of caffeine-induced contraction of guinea-pig aortic smooth muscle. *Biochem. Biophys. Res. Commun.* **154**: 219–226, 1988.
- ARCHER, S. L., HUANG, J. M., HAMPL, V., NELSON, D. P., SHULTZ, P. J., AND WEIR, E. K.: Nitric oxide and cGMP cause vasorelaxation by activation of a charybdotoxin-sensitive K channel by cGMP-dependent protein kinase. *Proc. Natl. Acad. Sci. USA* **91**: 7583–7587, 1994.
- ARNAUDEAU, S., LEPRETRE, N., AND MIRONNEAU, J.: Oxytocin mobilizes calcium from a unique heparin-sensitive and thapsigargin-sensitive store in single myometrial cells from pregnant rats. *Pfluegers Arch.* **428**: 51–59, 1994.
- ARNOLD, W. P., MITTAL, C. K., KATSUKI, S., AND MURAD, F.: Nitric oxide activates guanylate cyclase and increases guanosine 3':5'-cyclic monophosphate levels in various tissue preparations. *Proc. Natl. Acad. Sci. USA* **74**: 3203–3207, 1977.
- ASANO, M., MATSUDA, T., HAYAKAWA, M., ITO, K. M., AND ITO, K.: Increased resting Ca^{2+} maintains the myogenic tone and activates K^+ channels in arteries from young spontaneously hypertensive rats. *Eur. J. Pharmacol.* **247**: 295–304, 1993.
- ASANO, M., MATSUNAGA, K., MIURA, M., ITO, K. M., SETO, M., SAKURADA, K., NAGUMO, H., SASAKI, Y., AND ITO, K.: Selectivity of action of staurosporine on Ca^{2+} movements and contractions in vascular smooth muscles. *Eur. J. Pharmacol.* **294**: 693–701, 1995a.
- ASANO, M., NOMURA, Y., ITO, K., UYAMA, Y., IMAIZUMI, Y., AND WATANABE, M.: Increased function of voltage-dependent Ca^{++} channels and Ca^{++} -activated K^+ channels in resting state of femoral arteries from spontaneously hypertensive rats at prehypertensive stage. *J. Pharmacol. Exp. Ther.* **275**: 775–783, 1995b.
- ASHIDA, T., SCHAEFFER, J., GOLDMAN, W. F., WADE, J. B., AND BLAUSTEIN, M. P.: Role of sarcoplasmic reticulum in arterial contraction: comparison of ryanodine's effect in a conduit and a muscular artery. *Circ. Res.* **62**: 854–863, 1988.
- ASHIZAWA, N., KOBAYASHI, F., TANAKA, Y., AND NAKAYAMA, K.: Relaxing action of okadaic acid, a black sponge toxin on the arterial smooth muscle. *Biochem. Biophys. Res. Commun.* **162**: 971–976, 1989.
- ASSENDER, J. W., KONTNY, E., AND FREDHOLM, B. B.: Expression of protein kinase C isoforms in smooth muscle cells in various states of differentiation. *FEBS Lett.* **342**: 76–80, 1994.
- AUGUSTINE, J. A., SECRIST, J. P., DANIELS, J. K., LEIBSON, P. J., AND ABRAHAM, R. T.: Signal transduction through the T cell antigen receptor: activation of phospholipase C through G protein-independent coupling. *J. Immunol.* **146**: 2889–2897, 1991.
- AUSTIN, C., AND WRAY, S.: The effects of extracellular pH and calcium change on force and intracellular calcium in rat vascular smooth muscle. *J. Physiol. (Lond.)* **488**: 281–291, 1995.
- AYAJIKI, K., KINDERMANN, M., HECKER, M., FLEMING, I., AND BUSSE, R.: Intracellular pH and tyrosine phosphorylation but not calcium determine shear stress-induced nitric oxide production in native endothelial cells. *Circ. Res.* **78**: 750–758, 1996.
- BALABAN, R. S.: Regulation of oxidative phosphorylation in the mammalian cell. *Am. J. Physiol.* **258**: C377–C389, 1990.
- BALWIERCZAK, J. L.: The relationship of KCl^- and prostaglandin $F_{2\alpha}$ -mediated increases in tension of the porcine coronary artery with changes in intracellular Ca^{2+} measured with fura-2. *Br. J. Pharmacol.* **104**: 373–378, 1991.
- BARO, I., AND EISNER, D. A.: Factors controlling changes in intracellular Ca^{2+} concentration produced by noradrenaline in rat mesenteric artery smooth muscle cells. *J. Physiol. (Lond.)* **482**: 247–258, 1995.
- BATLLE, D. C., GODINICH, M., LAPOINTE, M. S., MUNOZ, E., CARONE, F., AND MEHRING, N.: Extracellular Na^+ dependency of free cytosolic Ca^{2+} regulation in aortic vascular smooth muscle cells. *Am. J. Physiol.* **261**: C845–C856, 1991.
- BENCHEKROUN, M. T., GROS-LOUIS, N., BKAILY, G., AND D'ORLEANS-JUSTE, P.: R-type calcium channel involved in endothelin-1-induced contraction of rabbit aorta. *J. Cardiovasc. Pharmacol.* **26**(suppl. 3): S300–S302, 1995.
- BENDHACK, L. M., SHARMA, R. V., AND BHALLA, R. C.: Altered signal transduction in vascular smooth muscle cells of spontaneously hypertensive rats. *Hypertension* **19**(suppl. 2): 145–146, 1992.
- BENHAM, C. D.: ATP-activated channels gate calcium entry in single smooth muscle cells dissociated from rabbit ear artery. *J. Physiol. (Lond.)* **419**: 689–701, 1989.
- BENHAM, C. D.: ATP-gated cation channels in vascular smooth muscle cells. *Jpn. J. Pharmacol.* **58**(suppl. 2): 179P–184P, 1992.
- BENHAM, C. D., AND BOLTON, T. B.: Spontaneous transient outward currents in single visceral and vascular smooth muscle cells of the rabbit. *J. Physiol. (Lond.)* **381**: 385–406, 1986.
- BENHAM, C. D., AND TSIEN, R. W.: A novel receptor-operated Ca^{2+} -permeable channel activated by ATP in smooth muscle. *Nature (Lond.)* **328**: 275–278, 1987.
- BENHAM, C. D., AND TSIEN, R. W.: Noradrenaline modulation of calcium channels in single smooth muscle cells from rabbit ear artery. *J. Physiol. (Lond.)* **404**: 67–84, 1988.
- BERMAN, D. M., AND GOLDMAN, W. F.: Stored calcium modulates inositol phosphate synthesis in cultured smooth muscle cells. *Am. J. Physiol.* **263**: C535–C539, 1992.
- BERTA, P., PHANEUF, S., DERANCOURT, J., CASANOVA, J., DURAND-CLEMENT, M., LE PEUCH, C., HAIECH, J., AND CAVADORE, J. C.: The effects of maitotoxin on phosphoinositides and calcium metabolism in a primary culture of aortic smooth muscle cells. *Toxicol.* **26**: 133–141, 1988.
- BERTA, P., SLADCEK, F., DERANCOURT, J., DURAND, M., TRAVO, P., AND HAIECH, J.: Maitotoxin stimulates the formation of inositol phosphates in rat aortic myocytes. *FEBS Lett.* **197**: 349–352, 1986.
- BHALLA, R. C., AND SHARMA, R. V.: Competitive interaction of amiloride and verapamil with α -adrenoceptors in vascular smooth muscle. *J. Cardiovasc. Pharmacol.* **8**: 927–932, 1986.
- BIALOJAN, C., AND TAKAI, A.: Inhibitory effect of a marine-sponge toxin, okadaic acid, on protein phosphatases. *Biochem. J.* **256**: 283–290, 1988.
- BIRD, G. S. J., AND PUTNEY, J. W.: Inhibition of thapsigargin-induced calcium entry by microinjected guanine nucleotide analogues. *J. Biol. Chem.* **268**: 21486–21488, 1993.
- BKAILY, G., ECONOMOS, D., POTVIN, L., ARDILLOUZE, J. L., MARRIOTT, C., CORCOS, J., BONNEAU, D., AND FONG, C. N.: Blockade of insulin sensitive steady-state R-type Ca^{2+} channel by PN 200–110 in heart and vascular smooth muscle. *Mol. Cell. Biochem.* **117**: 93–106, 1992.
- BLATTER, L. A.: Depletion and filling of intracellular calcium stores in vascular smooth muscle. *Am. J. Physiol.* **268**: C503–C512, 1995.
- BLINKS, J. R., MATTINGLY, P. H., JEWELL, B. R., VAN LEEUWEN, M., HARRER, G. C., AND ALLEN, D. G.: Practical aspects of the use of aequorin as a calcium indicator: assay, preparation, microinjection, and interpretation of signals. *Methods Enzymol.* **57**: 292–328, 1978.
- BOBIK, A., AND CAMPBELL, J. H.: Vascular derived growth factors: cell biology, pathophysiology, and pharmacology. *Pharmacol. Rev.* **45**: 1–42, 1993.
- BOBIK, A., WEISSBERG, P. L., AND LITTLE, P. J.: Spontaneous oscillations in cytoplasmic free calcium concentration in vascular smooth muscle: a potential mechanism associated with myogenic tone. *Clin. Exp. Pharmacol. Physiol.* **15**: 281–284, 1988.
- BOCHKOV, V., TKACHUK, V., BUHLER, F., AND RESINK, T.: Phosphoinositide and calcium signaling responses in smooth muscle cells: comparison between lipoproteins, Ang II and PDGF. *Biochem. Biophys. Res. Commun.* **188**: 1295–1304, 1992.
- BOHR, D. F.: Vascular smooth muscle: dual effect of calcium. *Science (Wash. DC)* **139**: 597–599, 1963.
- BOHR, D. F.: Electrolites and smooth muscle contraction. *Pharmacol. Rev.* **16**: 85–111, 1964.
- BOHR, D. F.: Vascular smooth muscle updated. *Circ. Res.* **32**: 665–672, 1973.
- BOLAND, B., HIMPENS, B., PAQUES, C., CASTEELS, R., AND GILLIS, J. M.: ATP induced-relaxation in the mouse bladder smooth muscle. *Br. J. Pharmacol.* **108**: 749–753, 1993.
- BOLOTINA, V. M., NAJIBI, S., PALACINO, J. J., PAGANO, P. J., AND COHEN, R. A.: Nitric oxide directly activates calcium-dependent potassium channel in vascular smooth muscle. *Nature (Lond.)* **368**: 850–853, 1994.
- BOLTON, T. B.: Mechanisms of action of transmitters and other substances on smooth muscle. *Physiol. Rev.* **59**: 606–718, 1979.

- BOLTON, T. B., AND IMAIZUMI, Y.: Spontaneous transient outward currents in smooth muscle cells. *Cell Calcium* **20**: 141–152, 1996.
- BONACCORSI, A., HERMSMEYER, K., APRIGLIANO, O., SMITH, C. B., AND BOHR, D. F.: Norepinephrine release in isolated arteries induced by K-free solution. *Am. J. Physiol.* **232**: H140–H145, 1977.
- BOND, M., KITAZAWA, T., SOMLYO, A. P., AND SOMLYO, A. V.: Release and recycling of calcium by the sarcoplasmic reticulum in guinea-pig portal vein smooth muscle. *J. Physiol. (Lond.)* **355**: 677–695, 1984.
- BORIN, M. L., TRIBE, R. M., AND BLAUSTEIN, M. P.: Increased intracellular Na⁺ augments mobilization of Ca²⁺ from SR in vascular smooth muscle cells. *Am. J. Physiol.* **266**: C311–C317, 1994.
- BOSSU, J. L., ELHAMDANI, A., AND FELTZ, A.: Voltage-dependent calcium currents in freshly dissociated capillary endothelial cells. *FEBS Lett.* **255**: 377–380, 1989.
- BOSSU, J. L., ELHAMDANI, A., AND FELTZ, A.: Voltage-dependent calcium entry in confluent capillary endothelial cells. *FEBS Lett.* **299**: 239–242, 1992a.
- BOSSU, J. L., ELHAMDANI, A., FELTZ, A., TANZI, F., AUNIS, D., AND THIERSE, D.: Voltage-gated Ca entry in isolated bovine capillary endothelial cells: evidence of a new type of BAY K 8644-sensitive channel. *Pfluegers Arch.* **420**: 200–207, 1992b.
- BOURREAU, J. P., KWAN C. Y., AND DANIEL, E. E.: Distinct pathways to refill ACh-sensitive internal calcium stores in canine airway smooth muscle. *Am. J. Physiol.* **265**: C28–C35, 1993.
- BOURREAU, J. P., ZHANG, Z. D., LOW, A. M., KWAN, C. Y., AND DANIEL, E. E.: Ryanodine and the adrenergic, purinergic stimulation in the rat vas deferens smooth muscle: functional and radioligand binding studies. *J. Pharmacol. Exp. Ther.* **256**: 1063–1071, 1991.
- BOVA, S., GOLDMAN, W. F., YAUN, X. J., AND BLAUSTEIN, M. P.: Influence of Na⁺ gradient on Ca²⁺ transients and contraction in vascular smooth muscle. *Am. J. Physiol.* **259**: H409–H423, 1990.
- BRADING, A. F., AND SNEDDON, P.: Evidence for multiple sources of calcium for activation of the contractile mechanism of guinea-pig *taenia coli* on stimulation with carbachol. *Br. J. Pharmacol.* **70**: 229–240, 1980.
- BRADLEY, A. B., AND MORGAN, K. G.: Cellular Ca²⁺ monitored by aequorin in adenosine-mediated smooth muscle relaxation. *Am. J. Physiol.* **248**: H109–H117, 1985.
- BRIGGS, A. H.: Calcium movements during potassium contracture in isolated rabbit aortic strips. *Am. J. Physiol.* **203**: 849–852, 1962.
- BRIGGS, A. H., AND SHIBATA, S.: Ca and ouabain interaction on vascular smooth muscle. *Proc. Soc. Exp. Biol. Med.* **121**: 274–278, 1966.
- BRODERICK, R., AND SOMLYO, A. P.: Calcium and magnesium transport by in situ mitochondria: electron probe analysis of vascular smooth muscle. *Circ. Res.* **61**: 523–530, 1987.
- BRUSCHI, G., BRUSCHI, M. E., REGOLISTI, G., AND BORGHETTI, A.: Myoplasmic Ca²⁺-force relationship studied with fura-2 during stimulation of rat aortic smooth muscle. *Am. J. Physiol.* **254**: H840–H854, 1988.
- BUCHAN, K. W., AND MARTIN, W.: Modulation of barrier function of bovine aortic and pulmonary artery endothelial cells: dissociation from cytosolic calcium content. *Br. J. Pharmacol.* **107**: 932–938, 1992.
- BULBRING, E., AND TOMITA, T.: Catecholamine action on smooth muscle. *Pharmacol. Rev.* **39**: 49–96, 1987.
- BURKE, E., GERTHOFFER, W. T., SANDERS, K. M., AND PUBLICOVER, N. G.: Wortmannin inhibits contraction without altering electrical activity in canine gastric smooth muscle. *Am. J. Physiol.* **270**: C1405–C1412, 1996.
- BURYI, V., MOREL, N., SALOMONE, S., KERGER, S., AND GODFRAIND, T.: Evidence for a direct interaction of thapsigargin with voltage-dependent Ca²⁺ channel. *Naunyn-Schmiedeberg's Arch. Pharmacol.* **351**: 40–45, 1995.
- BUTCHER, R. W., AND SUTHERLAND, E. W.: Adenosine 3',5'-phosphate in biological materials: I. Purification and properties of cyclic 3',5'-nucleotide phosphodiesterase and use of this enzyme to characterize adenosine 3',5'-phosphate in human urine. *J. Biol. Chem.* **237**: 1244–1250, 1962.
- BYRON, K. L.: Vasopressin stimulates Ca²⁺ spiking activity in A7r5 vascular smooth muscle cells via activation of phospholipase A₂. *Circ. Res.* **78**: 813–820, 1996.
- BYRON, K. L., AND TAYLOR, C. W.: Spontaneous Ca²⁺ spiking in a vascular smooth muscle cell line is independent of the release of intracellular Ca²⁺ stores. *J. Biol. Chem.* **268**: 6945–6952, 1993.
- BYRON, K., AND TAYLOR, C. W.: Vasopressin stimulation of Ca²⁺ mobilization, two bivalent cation entry pathways and Ca²⁺ efflux in A7r5 rat smooth muscle cells. *J. Physiol. (Lond.)* **485**: 455–468, 1995.
- CARL, A., KENYON, J. L., UEMURA, D., FUSEYANI, N., AND SANDERS, K. M.: Regulation of Ca²⁺-activated K⁺ channels by protein kinase A and phosphatase inhibitors. *Am. J. Physiol.* **261**: C387–C392, 1991.
- CARL, A., LEE, H. K., AND SANDERS, K.: Regulation of ion channels in smooth muscle by calcium. *Am. J. Physiol.* **271**: C9–C34, 1996.
- CASTEELS, R., AND DROOGMANS, G.: Exchange characteristics of the noradrenaline-sensitive calcium store in vascular smooth muscle cells of rabbit ear artery. *J. Physiol. (Lond.)* **317**: 263–279, 1981.
- CASTEELS, R., KITAMURA, K., KURIYAMA, H., AND SUZUKI, H.: Excitation-contraction coupling in the smooth muscle cells of the rabbit main pulmonary artery. *J. Physiol. (Lond.)* **271**: 63–79, 1977.
- CASTEELS, R., AND LOGIN, I. S.: Reserpine has a direct action as a calcium antagonist on mammalian smooth muscle cells. *J. Physiol. (Lond.)* **340**: 403–414, 1983.
- CASTEELS, R., RAEYMAEKERS, L., SUZUKI, H., AND VAN ELDERE, J.: Tension response and ⁴⁵Ca release in vascular smooth muscle incubated in Ca-free solution. *Pfluegers Arch.* **392**: 139–145, 1981.
- CATTERALL, W. A.: Structure and function of voltage-gated ion channels. *Trends Pharmacol. Sci.* **16**: 500–506, 1993.
- CAUVIN, C., LOUZENHISER, R., AND VAN BREEMEN, C.: Mechanisms of calcium antagonist-induced vasodilation. *Ann. Rev. Pharmacol. Toxicol.* **23**: 373–396, 1983.
- CAUVIN, C., LUKEMAN, S., CAMERON, J., HWANG, O., MEISHERI, K., YAMAMOTO, H., AND VAN BREEMEN, C.: Theoretical bases for vascular selectivity of Ca²⁺ antagonists. *J. Cardiovasc. Pharmacol.* **6**(suppl. 4): S630–S638, 1984a.
- CAUVIN, C., SAIDA, K., AND VAN BREEMEN, C.: Extracellular Ca²⁺ dependence and diltiazem inhibition of contraction in rabbit conduit arteries and mesenteric resistance vessels. *Blood Vessels* **21**: 23–31, 1984b.
- CAVERO, I., SHEPPERSON, N., LEFEVRE-BORG, F., AND LANGER, S. Z.: Differential inhibition of vascular smooth muscle responses to alpha 1- and alpha 2-adrenoceptor agonists by diltiazem and verapamil. *Circ. Res.* **52**: 169–176, 1983.
- CAVERO, I., AND SPEDDING, M.: "Calcium antagonists": a class of drugs with a bright future: Part I. Cellular calcium homeostasis and calcium as a coupling messenger. *Life Sci.* **33**: 2571–2581, 1983.
- CHANCE, B.: The energy-linked reaction of calcium with mitochondria. *J. Biol. Chem.* **240**: 2729–2748, 1965.
- CHANG, K. C., OH, D. R., CHONG, W. S., CHUNG, S. Y., LEE, Y. S., KIM, S. H., NOH, H. K., SUH, J. S., TAKIZAWA, S., AND KARAKI, H.: GS354 and GS389: new type of calcium channel blockers. *Korean J. Pharmacol.* **27**: 45–52, 1991.
- CHARTIER, L., RANKIN, L. L., ALLEN, R. E., KATO, Y., FUSEYANI, N., KARAKI, H., WATABE, S., AND HARTSHORNE, D. J.: Calyculin-A increases the level of protein phosphorylation and changes the shape of 3T3 fibroblasts. *Cell Motil. Cytoskeleton* **18**: 26–40, 1991.
- CHEN, G., AND CHEUNG, D.: Pharmacological distinction of the hyperpolarization response to caffeine and acetylcholine in guinea-pig coronary endothelial cells. *Eur. J. Pharmacol.* **223**: 33–38, 1993.
- CHEN, G. F., AND SUZUKI, H.: Calcium dependency of the endothelium-dependent hyperpolarization in smooth muscle cells of the rabbit carotid artery. *J. Physiol. (Lond.)* **421**: 521–534, 1990.
- CHEN, Q., CANNELL, M., AND VAN BREEMEN, C.: The superficial buffer barrier in vascular smooth muscle. *Can. J. Physiol. Pharmacol.* **70**: 509–514, 1992.
- CHEN, Q., AND VAN BREEMEN, C.: The superficial buffer barrier in venous smooth muscle: sarcoplasmic reticulum refilling and unloading. *Br. J. Pharmacol.* **109**: 336–343, 1993.
- CHEN, X. L., AND REMBOLD, C. M.: Cyclic nucleotide-dependent regulation of Mn²⁺ influx, [Ca²⁺]_i and arterial smooth muscle relaxation. *Am. J. Physiol.* **263**: C468–C473, 1992.
- CHEN, X. L., AND REMBOLD, C. M.: pHi, [Ca²⁺]_i and myosin phosphorylation in histamine- and NH₄⁺-induced swine carotid artery contraction. *Hypertension* **25**: 482–489, 1995.
- CHEN, Y. H., CHEN, M. X., ALESSI, D. R., CAMPBELL, D. G., SHANAHAN, C., COHEN, P., AND COHEN, P. T.: Molecular cloning of cDNA encoding the 110 kDa and 21 kDa regulatory subunits of smooth muscle protein phosphatase 1M. *FEBS Lett.* **356**: 51–55, 1994.
- CHENG, H., LEDEBERER, W. J., AND CANNELL, M. B.: Calcium sparks: elementary events underlying excitation-contraction coupling in heart muscle. *Science (Wash. DC)* **262**: 740–744, 1993.
- CHOPRA, L. C., TWORT, C. H. C., CAMERON, I. R., AND WARD, J. P. T.: Inositol 1,4,5-trisphosphate-induced and guanosine 5'-O-(3-thiotriphosphate)-induced calcium release in cultured airway smooth muscle. *Br. J. Pharmacol.* **104**: 901–906, 1991.
- CHOPRA, L. C., TWORT, C. H. C., WARD, J. P. T., AND CAMERON, I. R.: Effects of heparin on inositol 1,4,5-trisphosphate and guanosine 5'-O-(3-thiotriphosphate)-induced calcium release in cultured smooth muscle cells from rabbit trachea. *Biochem. Biophys. Res. Commun.* **163**: 262–268, 1989.
- CHRIST, G. J., MORENO, A. P., MELMAN, A., AND SPRAY, D. C.: Gap junction-mediated intercellular diffusion of Ca²⁺ in cultured human corporal smooth muscle cells. *Am. J. Physiol.* **263**: C373–C383, 1992.
- COLDEN-STANFIELD, M., SCHILLING, W. P., RITCHIE, A. K., ESKIN, S. G., NAVARO, L. T., AND KUNZE, D. L.: Bradykinin-induced increases in cytosolic calcium and ionic currents in cultured bovine aortic endothelial cells. *Circ. Res.* **61**: 632–640, 1987.
- COLLINS, E. M., WALSH, M. P., AND MORGAN, K. G.: Contraction of single vascular smooth muscle cells by phenylephrine at constant [Ca²⁺]_i. *Am. J. Physiol.* **262**: H754–H762, 1992.
- CONGER, J. D., FALK, S. A., AND ROBINETTE, J. B.: Angiotensin II-induced changes in smooth muscle calcium in rat renal arterioles. *J. Am. Soc. Nephrol.* **3**: 1792–1803, 1993.
- CORNFIELD, D. N., STEVENS, T., MCMURTRY, I. F., ABMAN, S. H., AND RODMAN, D. M.: Acute hypoxia increases cytosolic calcium in fetal pulmonary artery smooth muscle cells. *Am. J. Physiol.* **265**: L53–L56, 1993.
- CORNFIELD, D. N., STEVENS, T., MCMURTRY, I. F., ABMAN, S. H., AND RODMAN, D. M.: Acute hypoxia causes membrane depolarization and calcium influx in fetal pulmonary artery smooth muscle cells. *Am. J. Physiol.* **266**: L469–L475, 1994.
- CORNWELL, T. L., AND LINCOLN, T. M.: Regulation of intracellular Ca²⁺ levels in cultured vascular smooth muscle cells: reduction of Ca²⁺ by atriopeptin

- and 8-bromo-cyclic GMP is mediated by cyclic GMP-dependent protein kinase. *J. Biol. Chem.* **264**: 1146–1155, 1989.
- CORSON, M. A., JAMES, N. L., LATTA, S. E., NEREM, R. M., BERK, B. C., AND HARRISON, D. G.: Phosphorylation of endothelial nitric oxide synthase in response to fluid shear stress. *Circ. Res.* **79**: 984–991, 1996.
- CRICHTON, C. A., TEMPLETON, A. G., AND SMITH, G. L.: Effect of altered bathing pH on calcium activated force in α toxin permeabilised rat portal vein and human umbilical artery. *Cardiovasc. Res.* **28**: 1378–1384, 1994.
- D'ANGELO, E. K., SINGER, H. A., AND REMBOLD, C. M.: Magnesium relaxes arterial smooth muscle by decreasing intracellular Ca^{2+} without changing intracellular Mg^{2+} . *J. Clin. Invest.* **89**: 1988–1994, 1992.
- DANTHULURI, N. R., CYBULSKY, M. I., AND BROCK, T. A.: ACh-induced calcium transients in primary cultures of rabbit aortic endothelial cells. *Am. J. Physiol.* **255**: H1549–H1553, 1988.
- DARBY, P. J., KWAN, C. Y., AND DANIEL, E. E.: Use of calcium pump inhibitors in the study of calcium regulation in smooth muscle. *Biol. Signals* **2**: 293–304, 1993.
- DECLERCK, I., HIMPENS, B., DROOGMANS, G., AND CASTEELS, R.: The α_1 -agonist phenylephrine inhibits voltage-gated Ca^{2+} -channels in vascular smooth muscle cells of rabbit ear artery. *Pfluegers Arch.* **417**: 117–119, 1990.
- DE FEO, T. T., AND MORGAN, K. G.: Calcium-force relationships as detected with aequorin in two different vascular smooth muscles of the ferret. *J. Physiol. (Lond.)* **369**: 269–282, 1985.
- DE FEO, T. T., AND MORGAN, K. G.: Calcium-force coupling mechanisms during vasodilator-induced relaxation of ferret aorta. *J. Physiol. (Lond.)* **412**: 123–133, 1989.
- DE LANEROLLE, P., NISHIKAWA, P., YOST, D. A., AND ADELSTEIN, R. S.: Increased phosphorylation of myosin light chain kinase after an increase in cyclic AMP in intact smooth muscle. *Science (Wash. DC)* **223**: 1415–1417, 1984.
- DELSISLE, S., AND WELSH, M. J.: Inositol triphosphate is required for the propagation of calcium waves in *Xenopus* oocytes. *J. Biol. Chem.* **267**: 7963–7966, 1992.
- DEMER, L. L., WORTHAM, C. M., DIRKSEN, E. R., AND SANDERSON, M. J.: Mechanical stimulation induces intracellular calcium signaling in bovine aortic endothelial cells. *Am. J. Physiol.* **264**: H2094–H2102, 1993.
- DEMIREL, E., LASKEY, R. E., PURKERSON, S., AND VAN BREEMEN, C.: The passive calcium leak in cultured porcine aortic endothelial cells. *Biochem. Biophys. Res. Comm.* **191**: 1197–1203, 1993.
- DERIAN, C. K., AND MOSKOWITZ, M. A.: Polyphosphoinositide hydrolysis in endothelial cells and carotid artery segments. *J. Biol. Chem.* **261**: 3831–3837, 1986.
- DESILETS, M., DRISKA, S. P., AND BAUMGARTEN, C. M.: Current fluctuations and oscillations in smooth muscle cells from hog carotid artery. Role of the sarcoplasmic reticulum. *Circ. Res.* **65**: 708–722, 1989.
- DETH, R., AND VAN BREEMEN, C.: Relative contributions of Ca^{2+} influx and cellular Ca^{2+} release during drug induced activation of the rabbit aorta. *Pfluegers Arch.* **348**: 13–22, 1974.
- DETH, R., AND VAN BREEMEN, C.: Agonist induced release of intracellular Ca^{2+} in the rabbit aorta. *J. Memb. Biol.* **30**: 363–380, 1977.
- DEVINE, C. E., SOMLYO, A. V., AND SOMLYO, A. P.: Sarcoplasmic reticulum and excitation-contraction coupling in mammalian smooth muscles. *J. Cell Biol.* **52**: 690–718, 1972.
- DI SALVO, J., KAPLAN, N., AND SEMENCHUK, L. A.: Protein tyrosine phosphorylation and regulation of intracellular calcium in smooth muscle cells. *In* *Biochemistry of Smooth Muscle Contraction*, ed. by M. Barany, pp. 283–293, Academic Press, New York, 1996.
- DI SALVO, J., PFITZER, G., AND SEMENCHUK, L. A.: Protein tyrosine phosphorylation, cellular Ca^{2+} , and Ca^{2+} sensitivity for contraction of smooth muscle. *Can. J. Physiol. Pharmacol.* **72**: 1434–1439, 1994.
- DI SALVO, J., SEMENCHUK, L. A., AND LAUER, J.: Vanadate-induced contraction of smooth muscle and enhanced protein tyrosine phosphorylation. *Arch. Biochem. Biophys.* **304**: 386–391, 1993a.
- DI SALVO, J., STEUSLOFF, A., SEMENCHUK, L., SATOH, S., KOLQUIST, K., AND PFITZER, G.: Tyrosine kinase inhibitors suppress agonist-induced contraction in smooth muscle. *Biochem. Biophys. Res. Commun.* **190**: 968–974, 1993b.
- DICK, G. M., AND STUREK, M.: Effects of a physiological insulin concentration on the endothelin-sensitive Ca^{2+} store in porcine coronary artery smooth muscle. *Diabetes* **45**: 876–880, 1996.
- DICKENSON, J. M., AND HILL, S. J.: Histamine H_1 -receptor-mediated calcium influx in DDT1MF-2 cells. *Biochem. J.* **284**: 425–431, 1992.
- DICKENSON, J. M., AND HILL, S. J.: Homologous and heterologous desensitization of histamine H_1 - and ATP-receptors in the smooth muscle cell line, DDT1MF-2: the role of protein kinase C. *Br. J. Pharmacol.* **110**: 1449–1456, 1993.
- DIETRICH, H. H., KIMURA, M., AND DACEY, R. G., JR.: N^{ω} -nitro-L-arginine constricts cerebral arterioles without increasing intracellular calcium levels. *Am. J. Physiol.* **266**: H1681–H1686, 1994.
- DIXON, B. S., SHARMA, R. V., DICKERSON, T., AND FORTUNE, J.: Bradykinin and angiotensin II: activation of protein kinase C in arterial smooth muscle. *Am. J. Physiol.* **266**: C1406–C1420, 1994.
- DORN, G. W., JR., AND BECKER, M. W.: Thromboxane A_2 stimulated signal transduction in vascular smooth muscle. *J. Pharmacol. Exp. Ther.* **265**: 447–456, 1993.
- DORN, G. W., JR., BECKER, M. W., AND DAVIS, M. G.: Dissociation of the contractile and hypertrophic effects of vasoconstrictor prostanoids in vascular smooth muscle. *J. Biol. Chem.* **267**: 24897–24905, 1992.
- DOSTAL, D. E., MURAHASHI, T., AND PEACH, M. J.: Regulation of cytosolic calcium by angiotensins in vascular smooth muscle. *Hypertension* **15**: 815–822, 1990.
- DROOGMANS, G., AND CASTEELS, R.: Sodium and calcium interactions in vascular smooth muscle cells of the rabbit ear artery. *J. Gen. Physiol.* **74**: 57–70, 1979.
- DRUMMOND, R. M., AND FAY, F. S.: Mitochondria contribute to Ca^{2+} removal in smooth muscle cells. *Pfluegers Arch.* **431**: 473–482, 1996.
- DULL, R. O., AND DAVIES, P. F.: Flow modulation of agonist (ATP)-response (Ca^{2+}) coupling in vascular endothelial cells. *Am. J. Physiol.* **261**: H149–H154, 1991.
- EBASHI, S.: Development of Ca^{2+} concept in smooth muscle research. *In* *Frontiers in Smooth Muscle Research*, ed. by N. Sperelakis, and J. D. Wood, pp. 159–165, Alan R. Liss, New York, 1990.
- EBASHI, S.: Excitation-contraction coupling and the mechanism of muscle contraction. *Ann. Rev. Physiol.* **53**: 1–16, 1991.
- EGGERMONT, J. A., WUYTACK, F., DE-JAEGERE, S., NELLES, L., AND CASTEELS, R.: Evidence for two isoforms of the endoplasmic reticulum calcium pump in pig smooth muscle. *Biochem. J.* **260**: 757–762, 1989.
- ENDO, M.: Calcium release from the sarcoplasmic reticulum. *Pharmacol. Rev.* **57**: 71–108, 1977.
- ENDO, M., KITAZAWA, T., YAGI, S., IINO, M., AND KAKUTA, Y.: Some properties of chemically skinned smooth muscle fibers. *In* *Excitation-Contraction Coupling in Smooth Muscle*, ed. by R. Casteels, T. Godfraind, and J. C. Ruegg, pp. 199–209, Elsevier/North-Holland Biomedical Press, Amsterdam, 1977.
- ENOKI, T., MIWA, S., SAKAMOTO, A., MINOWA, T., KOMURO, T., KOBAYASHI, S., NINOMIYA, H., AND MASAKI, T.: Functional coupling of ET_A receptor with Ca^{2+} -permeable nonselective cation channel in mouse fibroblasts and rabbit aortic smooth muscle cells. *J. Cardiovasc. Pharmacol.* **26**(suppl. 3): S258–S261, 1995a.
- ENOKI, T., MIWA, S., SAKAMOTO, A., MINOWA, T., KOMURO, T., KOBAYASHI, S., NINOMIYA, H., AND MASAKI, T.: Long-lasting activation of cation current by low concentration of endothelin-1 in mouse fibroblasts and smooth muscle cells of rabbit aorta. *Br. J. Pharmacol.* **115**: 479–485, 1995b.
- ERDBRUGGER, W., VISCHER, P., BAUCH, H. J., AND MICHEL, M. C.: Norepinephrine and neuropeptide Y increase intracellular Ca^{2+} in cultured porcine aortic smooth muscle cells. *J. Cardiovasc. Pharmacol.* **22**: 97–102, 1993.
- ERIKSSON, J. E., GRONBERG, L., NYGARD, S., SLOTTJE, J. P., AND MERILUOTO, J. A. O.: Hepatocellular uptake of tritiated dihydromicrocystin-LR, a cyclic peptide toxin. *Biochim. Biophys. Acta.* **1025**: 60–66, 1990a.
- ERIKSSON, J. E., TOIVOLA, D., MERILUOTO, J. A. O., KARAKI, H., HAN, Y. -G., AND HARTSHORNE, D. J.: Hepatocyte deformation induced by cyanobacterial toxins reflects inhibition of protein phosphatases. *Biochem. Biophys. Res. Commun.* **173**: 1347–1353, 1990b.
- ETTER, E. F., KUHN, M. A., AND FAY, F. S.: Detection of changes in near-membrane Ca^{2+} concentration using a novel membrane-associated Ca^{2+} indicator. *J. Biol. Chem.* **269**: 10141–10149, 1994.
- ETTER, E. F., MINTA, A., POENIE, M., AND FAY, F. S.: Near-membrane [Ca^{2+}] transients resolved using the Ca^{2+} indicator FFP18. *Proc. Natl. Acad. Sci. Usa* **93**: 5368–5373, 1996.
- FALCONE, J. C.: Endothelial cell calcium and vascular control. *Med. Sci. Sports Exerc.* **27**: 1165–1169, 1995.
- FARHAT, M. Y., LAVIGNE, M. C., AND RAMWELL, P. W.: The vascular protective effects of estrogen. *FASEB J.* **10**: 615–624, 1996.
- FASOLATO, C., HOTH, M., AND PENNER, R.: A GTP-dependent step in the activation mechanism of capacitance calcium entry. *J. Biol. Chem.* **268**: 20737–20740, 1993.
- FAY, F. S., SHELVIN, H. H., GRANGER, W. C., AND TAYLOR, S. R.: Aequorin luminescence during activation of single isolated smooth muscle cells. *Nature (Lond.)* **280**: 506–508, 1979.
- FELBEL, J., TROCKUR, B., ECKER, T., LANDGRAF, W., AND HOFMANN, F.: Regulation of cytosolic calcium by cAMP and cGMP in freshly isolated smooth muscle cells from bovine trachea. *J. Biol. Chem.* **263**: 16764–16771, 1988.
- FERRIS, C. D., AND SNYDER, S. H.: Inositol 1,4,5-trisphosphate-activated calcium channels. *Ann. Rev. Physiol.* **54**: 469–488, 1992.
- FEUERSTEIN, G., AND HALLENBECK, J. M.: Prostaglandins, leukotrienes, and platelet-activating factor in shock. *Ann. Rev. Pharmacol. Toxicol.* **27**: 301–313, 1987.
- FILIPAEANU, C. M., BRAILOIU, E., HUHUREZ, G., SLATINEANU, S., BALTATU, O., AND BRANISTEANU, D. D.: Multiple effects of tyrosine kinase inhibitors on vascular smooth muscle contraction. *Eur. J. Pharmacol.* **281**: 29–35, 1995.
- FLEISCHMANN, B. K., MURRAY, R. K., AND KOTLIKOFF, M. I.: A voltage window for sustained elevation of cytosolic calcium in smooth muscle cells. *Proc. Natl. Acad. Sci. USA* **91**: 11914–11918, 1994.
- FLEISCHMANN, B. K., WANG, Y. -X., PRING, M., AND KOTLIKOFF, M. I.: Voltage-dependent calcium currents and cytosolic calcium in equine airway myocytes. *J. Physiol. (Lond.)* **492**: 347–358, 1996.
- FLEMING, I., FISSLTHALER, B., AND BUSSE, R.: Calcium signaling in endothelial cells involves activation of tyrosine kinases and leads to activation of mitogen-activated protein kinases. *Circ. Res.* **76**: 522–529, 1995.
- FOX, A. A., BORCHARD, U., AND NEUMANN, M.: Effects of vanadate on isolated

- vascular tissue: biochemical and functional investigations. *J. Cardiovasc. Pharmacol.* **5**: 309–316, 1983.
- FRANCO-OBREGON, A., URENA, J., AND LOPEZ-BARNEO, J.: Oxygen-sensitive calcium channels in vascular smooth muscle and their possible role in hypoxic arterial relaxation. *Proc. Natl. Acad. Sci. USA* **92**: 4715–4719, 1995.
- FREAY, A., JOHNS, A., ADAMS, D. J., RYAN, U. S., AND VAN BREEMEN, C.: Bradykinin and inositol 1,4,5-triphosphate-stimulated calcium release from intracellular stores in cultured bovine endothelial cells. *Pfluegers Arch.* **414**: 377–384, 1989.
- FREDHOLM, B. B., BRODIN, K., AND STRADBERG, K.: On the mechanism of relaxation of tracheal muscle by theophylline and other cyclic nucleotide phosphodiesterase inhibitors. *Acta Pharmacol. Toxicol.* **45**: 336–344, 1979.
- FUJIHARA, H., FUKUDA, S., FUJIWARA, N., AND SHIMOJI, K.: The effects of halothane on arginine-vasopressin-induced Ca^{2+} mobilization from the intracellular stores and the receptor-mediated Ca^{2+} entry from the extracellular space in single cultured smooth muscle cells of rat aorta. *Anesth. Analg.* **83**: 584–590, 1996.
- FUJIHARA, H., FUKUDA, S., TANAKA, T., KANAZAWA, H., FUJIWARA, N., AND SHIMOJI, K.: Arginine vasopressin increases perinuclear $[Ca^{2+}]_i$ in single cultured vascular smooth muscle cells of rat aorta. *J. Vasc. Res.* **30**: 231–238, 1993.
- FUJITA, A., TAKEUCHI, T., NAKAJIMA, H., NISHIO, H., AND HATA, F.: Involvement of heterotrimeric GTP-binding protein and rho protein, but not protein kinase C, in agonist-induced Ca^{2+} sensitization of skinned muscle of guinea pig vas deferens. *J. Pharmacol. Exp. Ther.* **274**: 551–561, 1995.
- FUJIWARA, T., SUMIMOTO, K., ITOH, T., SUZUKI, H., AND KURIYAMA, H.: Relaxing actions of procaterol, a β_2 -adrenoceptor stimulant, on smooth muscle cells of the dog trachea. *Br. J. Pharmacol.* **93**: 199–209, 1988.
- FUKAO, M., HATTORI, Y., KANNO, M., SAKUMA, I., AND KITABATAKE, A.: Thapsigargin- and cyclopiazonic acid-induced hyperpolarization in rat mesenteric artery. *Br. J. Pharmacol.* **115**: 987–992, 1995.
- FUKUO, K., MORIMOTO, S., KOH, E., YUKAWA, S., TSUCHIYA, H., IMANAKA, S., YAMAMOTO, H., ONISHI, T., AND KUMAHARA, Y.: Effects of prostaglandins on the cytosolic free calcium concentration in vascular smooth muscle cells. *Biochem. Biophys. Res. Comm.* **136**: 247–252, 1986.
- FUKUZAKI, A., SUGA, O., KARIBE, H., MIYAUCHI, Y., GOKITA, T., AND UCHIDA, M. K.: Ca^{2+} -independent contraction of uterine smooth muscle induced by vanadate and its inhibition by Ca^{2+} . *Eur. J. Pharmacol.* **220**: 99–102, 1992.
- FURUKAWA, K. -I., KOMABA, J., SAKAI, H., AND OHIZUMI, Y.: The mechanism of acidic pH-induced contraction in aortae from SHR and WKY rats enhanced by increasing blood pressure. *Br. J. Pharmacol.* **118**: 485–492, 1996.
- FURUKAWA, K. -I., TAWADA, Y., AND SHIGEKAWA, M.: Regulation of the plasma membrane Ca^{2+} pump by cyclic nucleotides in cultured vascular smooth muscle cell. *J. Biol. Chem.* **263**: 8058–8065, 1988.
- FURUKAWA, K. -I., TAWADA, Y., AND SHIGEKAWA, M.: Protein kinase C activation stimulates plasma membrane calcium pump in cultured vascular smooth muscle cells. *J. Biol. Chem.* **264**: 4844–4849, 1989.
- GANITKEVICH, V., AND ISENBERG, G.: Isolated guinea pig coronary smooth muscle cells. Acetylcholine induces hyperpolarization due to sarcoplasmic reticulum calcium release activating potassium channels. *Circ. Res.* **67**: 525–528, 1990.
- GANITKEVICH, V. Y., AND ISENBERG, G.: Depolarization-mediated intracellular calcium transients in isolated smooth muscle cells of guinea-pig urinary bladder. *J. Physiol. (Lond.)* **435**: 187–205, 1991.
- GANITKEVICH, V. Y., AND ISENBERG, G.: Contribution of Ca^{2+} -induced Ca^{2+} release to the $[Ca^{2+}]_i$ transients in myocytes from guinea-pig urinary bladder. *J. Physiol. (Lond.)* **458**: 119–137, 1992.
- GANITKEVICH, V. Y., AND ISENBERG, G.: Ca^{2+} entry through Na^+ - Ca^{2+} exchange can trigger Ca^{2+} release from Ca^{2+} stores in Na^+ loaded guinea-pig coronary myocytes. *J. Physiol. (Lond.)* **468**: 225–243, 1993a.
- GANITKEVICH, V. Y., AND ISENBERG, G.: Membrane potential modulates inositol 1,4,5-trisphosphate-mediated Ca^{2+} transients in guinea-pig coronary myocytes. *J. Physiol. (Lond.)* **470**: 35–44, 1993b.
- GANITKEVICH, V. Y., AND ISENBERG, G.: Dissociation of subsarcolemmal from global cytosolic $[Ca^{2+}]_i$ in myocytes from guinea-pig coronary artery. *J. Physiol. (Lond.)* **490**: 305–318, 1996a.
- GANITKEVICH, V. Y., AND ISENBERG, G.: Effect of membrane potential on the initiation of acetylcholine-induced Ca^{2+} transients in isolated guinea pig coronary myocytes. *Circ. Res.* **78**: 717–723, 1996b.
- GARDNER, J. P., TOKUDOME, G., TOMONARI, H., MAHER, E., HOLLANDER, D., AND AVIV, A.: Endothelin-induced calcium responses in human vascular smooth muscle cells. *Am. J. Physiol.* **262**: C148–155, 1992.
- GEIGER, R. V., BERK, B. C., ALEXANDER, R. W., AND NEREM, R. M.: Flow-induced calcium transients in single endothelial cells: spatial and temporal analysis. *Am. J. Physiol.* **262**: C1411–C1417, 1992.
- GERICKE, M., OIKE, M., DROGMANS, G., AND NILIUS, B.: Inhibition of capacitative Ca^{2+} entry by a Cl^- channel blocker in human endothelial cells. *Eur. J. Pharmacol. Mol. Pharmacol. Sec* **269**: 381–384, 1994.
- GERTHOFFER, W. T., MURPHEY, K. A., AND GUNST, S. J.: Aequorin luminescence, myosin phosphorylation and active stress in tracheal smooth muscle. *Am. J. Physiol.* **257**: C1062–C1068, 1989.
- GERTHOFFER, W. T., MURPHEY, K. A., AND KHOYI, M. A.: Inhibition of tracheal smooth muscle contraction and myosin phosphorylation by ryanodine. *J. Pharmacol. Exp. Ther.* **246**: 585–590, 1988.
- GERTHOFFER, W. T., AND POHL, J.: Caldesmon and calponin phosphorylation in regulation of smooth muscle contraction. *Can. J. Physiol. Pharmacol.* **72**: 1410–1414, 1994.
- GHIGO, D., BUSSOLINO, F., GARBARINO, G., HELLER, R., TURRINI, F., PESCAROMONA, G., CRAGOE, E. J., PEGORARO, L., AND BOSIA, A.: Role of Na^+/H^+ exchange in thrombin-induced platelet-activating factor production by human endothelial cells. *J. Biol. Chem.* **263**: 19437–19446, 1988.
- GHOSH, T. K., EIS, P. S., MULLANEY, J. M., EBERT, C. L., AND GILL, D. L.: Competitive, reversible, and potent antagonism of inositol 1,4,5-trisphosphate-activated calcium release by heparin. *J. Biol. Chem.* **263**: 11075–11079, 1988.
- GILKEY, J. C., JAFFE, L. F., RIDGWAY, E. B., AND REYNOLDS, G. T.: A free calcium wave traverses the activating egg of the medaka, *Oryzias latipes*. *J. Cell Biol.* **76**: 448–466, 1978.
- GILLESPIE, J. I., OTUN, H., GREENWELL, J. R., AND DUNLOP, W.: Evidence for Na^+ - Ca^{2+} exchange and Ca^{2+} -induced Ca^{2+} release in a cultured vascular smooth muscle cell line from the rat. *Exp. Physiol.* **77**: 141–152, 1992a.
- GILLESPIE, J. I., OTUN, H., GREENWELL, J. R., AND DUNLOP, W.: The effect of intracellular sodium and extracellular sodium on calcium mobilization in the rat aortic smooth muscle cell line A7r5. *Exp. Physiol.* **77**: 627–635, 1992b.
- GILLESPIE, J. I., OTUN, H., NICHOLLS, J. A., GREENWELL, J. R., AND DUNLOP, W.: Repetitive transients in intracellular Ca^{2+} in cultured human vascular smooth muscle cells. *Exp. Physiol.* **77**: 849–856, 1992c.
- GODFRAIND, T.: Calcium exchange in vascular smooth muscle, action of nor-adrenaline and lanthanum. *J. Physiol. (Lond.)* **260**: 21–35, 1976.
- GODFRAIND, T., DESSY, C., AND SALOMONE, S. A.: Comparison of the potency of selective L-calcium channel blockers in human coronary and internal mammary arteries exposed to serotonin. *J. Pharmacol. Exp. Ther.* **263**: 112–122, 1992.
- GODFRAIND, T., AND KABA, A.: Blockade or reversal of the contraction induced by calcium and adrenaline in depolarized arterial smooth muscle. *Br. J. Pharmacol.* **36**: 549–560, 1969.
- GODFRAIND, T., MILLER, R., AND WIBO, M.: Calcium antagonism and calcium entry blockade. *Pharmacol. Rev.* **38**: 321–416, 1986.
- GOEGER, D. E., AND RILEY, R. T.: Interaction of cyclopiazonic acid with rat skeletal muscle sarcoplasmic reticulum vesicles. Effect on Ca^{2+} binding and Ca^{2+} permeability. *Biochem. Pharmacol.* **38**: 3995–4003, 1989.
- GOKITA, T., MIYAUCHI, Y., AND UCHIDA, M. K.: Effects of tyrosine kinase inhibitor, genistein and phosphotyrosine-phosphatase inhibitor, orthovanadate, on Ca^{2+} -free contraction of uterine smooth muscle of the rat. *Gen. Pharmacol.* **25**: 1673–1677, 1994.
- GOLDMAN, W. F., BOVA, S., AND BLAUSTEIN, M. P.: Measurement of intracellular Ca^{2+} in cultured arterial smooth muscle cells using Fura-2 and digital imaging microscopy. *Cell Calcium* **11**: 221–231, 1990.
- GOLDMAN, W. F., WIER, W. G., AND BLAUSTEIN, M. P.: Effects of activation on distribution of Ca^{2+} in single arterial smooth muscle cells. Determination with fura-2 digital imaging microscopy. *Circ. Res.* **64**: 1019–1029, 1989.
- GOLOVINA, V. A., AND BLAUSTEIN, M. P.: Spatially and functionally distinct Ca^{2+} stores in sarcoplasmic and endoplasmic reticulum. *Science* **275**: 1643–1648, 1997.
- GONG, C., ZDERIC, S. A., AND LEVIN, R. M.: Ontogeny of the ryanodine receptor in rabbit urinary bladder smooth muscle. *Mol. Cell. Biochem.* **137**: 169–172, 1994.
- GONG, M. C., FUGLSANG, A. F., ALESSI, D., KOBAYASHI, S., COHEN, P., SOMLYO, A. V., AND SOMLYO, A. P.: Arachidonic acid inhibits myosin light chain phosphatase and sensitizes smooth muscle to calcium. *J. Biol. Chem.* **267**: 21492–21498, 1992.
- GONG, M. C., IZUKA, K., NIXON, G., BROWN, J. P., HALL, A., ECCLESTON, J. F., SUGAI, M., KOBAYASHI, S., SOMLYO, A. V., AND SOMLYO, A. P.: Role of guanine nucleotide-binding proteins –ras-family or trimeric proteins or both – in Ca^{2+} sensitization of smooth muscle. *Proc. Natl. Acad. Sci. USA* **93**: 1340–1345, 1996.
- GONG, M. C., KINTER, M. T., SOMLYO, A. V., AND SOMLYO, A. P.: Arachidonic acid and diacylglycerol release associated with inhibition of myosin light chain dephosphorylation in rabbit smooth muscle. *J. Physiol.* **486**: 113–122, 1995.
- GOODMAN, F. R., AND WEISS, G. B.: Dissociation by lanthanum of smooth muscle responses to potassium and acetylcholine. *Am. J. Physiol.* **220**: 759–766, 1971a.
- GOODMAN, F. R., AND WEISS, G. B.: Effects of lanthanum on ^{45}Ca movements and on contractions induced by norepinephrine, histamine and potassium in vascular smooth muscle. *J. Pharmacol. Exp. Ther.* **177**: 415–425, 1971b.
- GOODMAN, F. R., WEISS, G. B., KARAKI, H., AND NAKAGAWA, H.: Differential calcium movements induced by agonists in guinea pig tracheal muscle. *Eur. J. Pharmacol.* **133**: 111–117, 1987.
- GOTO, K., KASUYA, Y., MATSUKI, N., TAKUWA, Y., KURIHARA, H., ISHIKAWA, T., KIMURA, S., YANAGISAWA, M., AND MASAKI, T.: Endothelin activates the dihydropyridine-sensitive, voltage-dependent Ca^{2+} channel in vascular smooth muscle. *Proc. Natl. Acad. Sci. USA* **86**: 3915–3918, 1989.
- GOULD, E. M., REMBOLD, C. M., AND MURPHY, R. A.: Genistein, a tyrosine kinase inhibitor, reduces Ca^{2+} mobilization in swine carotid media. *Am. J. Physiol.* **268**: C1425–C1429, 1995.
- GRAIER, W. F., KUKOVETZ, W. R., AND GROSCHNER, K.: Cyclic AMP enhances agonist-induced Ca^{2+} entry into endothelial cells by activation of potassium

- channels and membrane hyperpolarization. *Biochem. J.* **291**: 263–267, 1993.
- GRAIER, W. F., SIMECEK, S., BOWLES, D. K., AND STUREK, M.: Heterogeneity of caffeine- and bradykinin-sensitive Ca^{2+} stores in vascular endothelial cells. *Biochem. J.* **300**: 637–641, 1994.
- GRAIER, W. F., SIMECEK, S., AND STUREK, M.: Cytochrome P₄₅₀ mono-oxygenase-regulated signaling of Ca^{2+} entry in human and bovine endothelial cells. *J. Physiol. (Lond.)* **482**: 259–274, 1995.
- GRAVES, L. M., BORNFELDT, K. E., SIDHU, J. S., ARGAST, G. M., RAINES, E. W., ROSS, R., LESLIE, C. C., AND KREBS, E. G.: Platelet-derived growth factor stimulates protein kinase A through a mitogen-activated protein kinase-dependent pathway in human arterial smooth muscle cells. *J. Biol. Chem.* **271**: 505–511, 1996.
- GRAY, G. A., LOFFLER, B. M., AND CLOZEL, M.: Characterization of endothelin receptors mediating contraction of rabbit saphenous vein. *Am. J. Physiol.* **266**: H959–H966, 1994.
- GREGOIRE, G., LOIRAND, G., AND PACAUD, P.: Ca^{2+} and Sr^{2+} entry induced Ca^{2+} release from the intracellular Ca^{2+} store in smooth muscle cells of rat portal vein. *J. Physiol. (Lond.)* **472**: 483–500, 1993.
- GRODEN, D. L., GUAN, Z., AND STOKES, B. T.: Determination of Fura-2 dissociation constants following adjustment of the apparent Ca-EGTA association constant for temperature and ionic strength. *Cell Calcium* **12**: 279–287, 1991.
- GROSCHNER, K., SCHUHMAN, K., BAUMGARTNER, W., PASTUSHENKO, V., GROVER, A. K., AND SAMSON, S. E.: Pig coronary artery smooth muscle: substrate and pH dependence of the two calcium pumps. *Am. J. Physiol.* **251**: C529–C534, 1986.
- GRYNKIEWICZ, G., POENIE, M., AND TSIEN, R. Y.: A new generation of Ca^{2+} indicators with greatly improved fluorescence properties. *J. Biol. Chem.* **260**: 3440–3450, 1985.
- GUERRERO, A., FAY, F. S., AND SINGER, J. J.: Caffeine activates a Ca^{2+} -permeable, nonselective cation channel in smooth muscle cells. *J. Gen. Physiol.* **104**: 375–394, 1994a.
- GUERRERO, A., SINGER, J. J., AND FAY, F. S.: Simultaneous measurement of Ca^{2+} release and influx into smooth muscle cells in response to caffeine. *J. Gen. Physiol.* **104**: 395–422, 1994b.
- GUNST, S. J., AND BANDYOPADHYAY, S.: Contractile force and intracellular Ca^{2+} during relaxation of canine tracheal smooth muscle. *Am. J. Physiol.* **257**: C355–C364, 1989.
- GUSOVSKY, F., YASUMOTO, T., AND DALY, J. W.: Maitotoxin, a potent, general activator of phosphoinositide breakdown. *FEBS Lett.* **243**: 307–312, 1989.
- HAGIWARA, S., MITSUI, M., AND KARAKI, H.: Effects of flodipine, nifedipine and verapamil on cytosolic Ca^{2+} and contraction in vascular smooth muscle. *Eur. J. Pharmacol.* **234**: 1–7, 1993.
- HALLAM, T. J., JACOB, R., AND MERRITT, J. E.: Influx of bivalent cations can be independent of receptor stimulation in human endothelial cells. *Biochem. J.* **259**: 125–129, 1989.
- HALLAM, T. J., AND PEARSON, J. D.: Exogenous ATP raises cytoplasmic free calcium in fura-2 loaded piglet aortic endothelial cells. *FEBS Lett.* **207**: 95–99, 1986.
- HALLER, H.: Calcium antagonists and cellular mechanisms of glomerulosclerosis and atherosclerosis. *Am. J. Kidney Dis.* **21**(6 Suppl 3): 26–31, 1993.
- HAN, S. Z., KARAKI, H., OUCHI, Y., AKISHITA, M., AND ORIMO, H.: $17\text{-}\beta$ -estradiol inhibits Ca^{2+} influx and Ca^{2+} release induced by thromboxane A₂ in porcine coronary artery. *Circulation* **91**: 2619–2626, 1995a.
- HAN, S. Z., OUCHI, Y., KARAKI, H., AND ORIMO, H.: Inhibitory effects of insulin on cytosolic Ca^{2+} level and contraction in the rat aorta: endothelium-dependent and independent mechanisms. *Circ. Res.* **77**: 673–678, 1995b.
- HARADA, K., HORI, M., OZAKI, H., AND KARAKI, H.: Endothelin-1 induces Ca^{2+} release without myosin light chain phosphorylation and contraction in rat aorta (abstract). *Jpn. J. Pharmacol. (suppl. 1)* **64**: 135P, 1994.
- HARADA, K., HORI, M., OZAKI, H., AND KARAKI, H.: Increase in intracellular Ca^{2+} level without increase in myosin light chain phosphorylation and contraction in rat aortic smooth muscle (abstract). *Jpn. J. Pharmacol. (suppl. 1)* **71**: 209P, 1996.
- HARASAWA, Y., KIMURA, M., AND HAYASHI, S.: Inhibitory effect of spiradoline, a κ opioid receptor agonist, on Ca^{2+} induced contraction and the intracellular Ca^{2+} concentration in porcine coronary artery. *Cardiovasc. Res.* **25**: 802–806, 1991.
- HARTSHORNE, D. J.: Biochemistry of the contractile process in smooth muscle. In *Physiology of the GI Tract*, Ed. by L. R. Johnson, Vol. 2, pp. 423–428, Raven Press, New York, 1987.
- HASHIMOTO, T., HIRATA, M., ITOH, T., KANMURA, Y., AND KURIYAMA, H.: Inositol 1,4,5-trisphosphate activates pharmacomechanical coupling in smooth muscle of the rabbit mesenteric artery. *J. Physiol. (Lond.)* **370**: 605–618, 1986.
- HASSID, A.: Atriopeptin II decreases cytosolic free Ca in cultured vascular smooth muscle cells. *Am. J. Physiol.* **251**: C681–C686, 1986.
- HECKER, M., MULSCH, A., BASSENGE, B., AND BUSSE, R.: Vasoconstriction and increased flow: two principal mechanisms of shear stress-dependent endothelial autacoid release. *Am. J. Physiol.* **265**: H828–H833, 1993.
- HELLSTRAND, P.: Energetics of smooth muscle contraction. In *Biochemistry of Smooth Muscle Contraction*, ed. by M. Barany, pp. 379–392. Academic Press, New York, 1996.
- HENRY, P. J.: Endothelin-1 (ET-1)-induced contraction in rat isolated trachea: involvement of ET_A and ET_B receptors and multiple signal transduction systems. *Br. J. Pharmacol.* **110**: 435–441, 1993.
- HERRMANN-FRANK, A., DARLING, E., AND MEISSNER, G.: Functional characterization of the calcium-gated calcium release channel of vascular smooth muscle sarcoplasmic reticulum. *Pfluegers Arch.* **418**: 353–359, 1991.
- HESCHELER, J., AND SCHULTZ, G.: Nonselective cation channel: Physiological and pharmacological modulations of channel activity. In *Nonselective Cation Channels: Pharmacology, Physiology, and Biophysics*, Ed. by D. Siemen and J. Hescheler, pp. 27–43, Birkhauser, Basel, 1993.
- HIDAKA, H., AND KOBAYASHI, R.: Pharmacology of protein kinase inhibitors. *Ann. Rev. Pharmacol. Toxicol.* **32**: 377–397, 1992.
- HIDAKA, H., INAGAKI, M., KAWAMOTO, S., AND SASAKI, Y.: Isoquinolinesulfonamides, novel and potent inhibitors of cyclic nucleotide-dependent kinase and protein kinase C. *Biochemistry* **23**: 5036–5041, 1984.
- HIGASHIO, T., AND KURODA, K.: Effects of cadralazine on contractions induced by Ca^{2+} and norepinephrine in isolated rabbit aortic strips. *Arzneim. Forsch.* **38**: 346–349, 1988a.
- HIGASHIO, T., AND KURODA, K.: Effects of cadralazine on contractions induced by norepinephrine, serotonin, angiotensin II and K^{+} in rabbit aortic and renal arterial strips. *Arzneim. Forsch.* **38**: 341–346, 1988b.
- HIMPENS, B.: Modulation of the Ca^{2+} -sensitivity in phasic and tonic smooth muscle. *Verh. K. Acad. Geneesk. Belg.* **54**: 217–251, 1992.
- HIMPENS, B., AND CASTEELS, R.: Different effects of depolarization and muscarinic stimulation on the Ca^{2+} /force relationship during the contraction-relaxation cycle in the guinea pig ileum. *Pfluegers Arch.* **416**: 28–35, 1990.
- HIMPENS, B., DE SMEDT, H., AND CASTEELS, R.: Kinetics of nucleocytoplasmic Ca^{2+} transients in DDT1 MF-2 smooth muscle cells. *Am. J. Physiol.* **263**: C978–C985, 1992a.
- HIMPENS, B., DE SMEDT, H., AND CASTEELS, R.: Staurosporine induced Ca^{2+} increase in DDT1MF-2 smooth muscle cells. *Am. J. Physiol.* **264**: C544–C551, 1993.
- HIMPENS, B., DE SMEDT, H., AND CASTEELS, R.: Subcellular Ca^{2+} -gradients in A7r5 vascular smooth muscle. *Cell Calcium* **15**: 55–65, 1994.
- HIMPENS, B., DE SMEDT, H., DROOGMANS, G., AND CASTEELS, R.: Differences in regulation between nuclear and cytoplasmic Ca^{2+} in cultured smooth muscle cells. *Am. J. Physiol.* **263**: C95–C105, 1992b.
- HIMPENS, B., KITAZAWA, T., AND SOMLYO, A. P.: Agonist-dependent modulation of Ca^{2+} sensitivity in rabbit pulmonary artery smooth muscle. *Pfluegers Arch.* **417**: 21–28, 1990.
- HIMPENS, B., MATTHIJS, G., SOMLYO, A. V., BUTLER, T. M., AND SOMLYO, A. P.: Cytoplasmic free calcium, myosin light chain phosphorylation, and force in phasic and tonic smooth muscle. *J. Gen. Physiol.* **92**: 713–729, 1988.
- HINO, T., NYBY, M. D., FITTINGOFF, M., TUCK, M. L., AND BRICKMAN, A. S.: Parathyroid hormone analogues inhibit calcium mobilization in cultured vascular cells. *Hypertension* **23**: 402–408, 1994.
- HIRAMATSU, T., KUME, H., KOTOLIKOFF, M. I., AND TAKAGI, K.: Role of calcium-activated potassium channels in the relaxation of tracheal smooth muscles by forskolin. *Clin. Exp. Pharmacol. Physiol.* **21**: 367–375, 1994.
- HIRANO, K., AND KANAIDE, H.: Cytosolic Ca^{2+} transients in endothelium-dependent relaxation of pig coronary artery, and effects of captopril. *Eur. J. Pharmacol.* **250**: 439–446, 1993.
- HIRANO, K., KANAIDE, H., ABE, S., AND NAKAMURA, M.: Temporal changes in the calcium-force relation during histamine-induced contractions of strips of the coronary artery of the pig. *Br. J. Pharmacol.* **102**: 27–34, 1991.
- HIRAOKA, M., YAMAGISHI, S., AND SANNO, T.: Role of calcium ions in the contraction of smooth muscle. *Am. J. Physiol.* **214**: 1084–1089, 1968.
- HIRATA, K., KIKUCHI, A., SASAKI, T., KURODA, S., KAIBUCHI, K., MATSUURA, Y., SEKI, H., SAIDA, K., AND TAKAI, Y.: Involvement of rho p21 GTP-enhanced calcium ion sensitivity of smooth muscle contraction. *J. Biol. Chem.* **267**: 8719–8722, 1992.
- HIRATA, Y., YOSHIMI, H., TAKATA, S., WATANABE, T. X., KUMAGAI, S., NAKAJIMA, K., AND SAKAKIBARA, S.: Cellular mechanism of action by a novel vasoconstrictor endothelin in cultured rat vascular smooth muscle cells. *Biochem. Biophys. Res. Commun.* **154**: 868–875, 1988.
- HISAYAMA, T., AND TAKAYANAGI, I.: Ryanodine: its possible mechanism of action in the caffeine-sensitive calcium store of smooth muscle. *Pfluegers Arch.* **412**: 376–381, 1988.
- HISAYAMA, T., TAKAYANAGI, I., AND OKAMOTO, Y.: Ryanodine reveals multiple contractile and relaxant mechanisms in vascular smooth muscle: simultaneous measurements of mechanical activity and of cytoplasmic free Ca^{2+} level with fura-2. *Br. J. Pharmacol.* **100**: 677–684, 1990.
- HOCHSTRATE, P., AND JUSE, A.: Intracellular free calcium concentration in the blowfly retina studied by Fura-2. *Cell Calcium* **12**: 695–712, 1991.
- HOFMANN, F., AND KLUGBAUER, N.: Molecular biology and expression of smooth muscle L-type calcium channels. In *Biochemistry of Smooth Muscle Contraction*, ed. by M. Barany, pp. 221–226, Academic Press, New York, 1996.
- HOLLENBERG, M. D.: The acute actions of growth factors in smooth muscle systems. *Life Sci.* **54**: 223–235, 1994a.
- HOLLENBERG, M. D.: Tyrosine kinase pathways and the regulation of smooth muscle contractility. *Trends Pharmacol. Sci.* **15**: 108–114, 1994b.
- HOLZMANN, S.: Cyclic GMP on possible mediator of coronary arterial relaxation by nicorandil (SG-75). *J. Cardiovasc. Pharmacol.* **5**: 364–370, 1983.
- HORI, M., MAGAE, J., HAN, Y. G., HARTSHORNE, D. J., AND KARAKI, H.: A novel protein phosphatase inhibitor, tautomycin: effect on smooth muscle. *FEBS Lett.* **285**: 145–148, 1991.
- HORI, M., SAITO, S., SHIN, Y., OZAKI, H., Fusetani, N., AND KARAKI, H.: Mycal-

- olide-B, a novel and specific inhibitor of actomyosin ATPase isolated from marine sponge. *FEBS Lett.* **322**: 151–154, 1993a.
- HORI, M., SATO, K., MIYAMOTO, S., OZAKI, H., AND KARAKI, H.: Different pathways of calcium sensitization activated by receptor agonists and phorbol esters in vascular smooth muscle. *Br. J. Pharmacol.* **110**: 1527–1531, 1993b.
- HORI, M., SATO, K., SAKATA, K., OZAKI, H., TAKANO-OHMURO, H., TSUCHIYA, T., SUGI, H., AND KARAKI, H.: Receptor agonists induced myosin phosphorylation-dependent and phosphorylation-independent contractions in vascular smooth muscle. *J. Pharmacol. Exp. Ther.* **261**: 506–512, 1992.
- HORI, M., SHIMIZU, K., NAKAJYO, S., AND URAKAWA, N.: Inhibitory effect of lithium on muscle contractions caused by various stimulants in guinea-pig ileum. *Eur. J. Pharmacol.* **165**: 63–70, 1989a.
- HORI, M., SHIMIZU, K., NAKAJYO, S., KARAKI, H., AND URAKAWA, N.: The inhibitory effect of Li^+ on contractile elements of intestinal smooth muscle. *Jpn. J. Pharmacol.* **68**: 111–118, 1995.
- HORI, M., SHIMIZU, K., NAKAJYO, S., AND URAKAWA, N.: The effect of trifluoperazine on muscle tension and cytoplasmic Ca^{2+} level in guinea pig ileum. *Jpn. J. Pharmacol.* **49**: 540–543, 1989b.
- HORIE, S., YANO, S., AIMI, N., SAKAI, S., AND WATANABE, K.: Effects of hirsutine, an antihypertensive indole alkaloid from *Uncaria rhynchophylla*, on intracellular calcium in rat thoracic aorta. *Life Sci.* **50**: 491–498, 1992.
- HOSOKI, E., AND IJIMA, T.: Chloride-sensitive Ca^{2+} entry by histamine and ATP in human aortic endothelial cells. *Eur. J. Pharmacol. Mol. Pharmacol. Sec.* **266**: 213–218, 1994.
- HOSOKI, E., AND IJIMA, T.: Modulation of cytosolic Ca^{2+} concentration by thapsigargin and cyclopiazonic acid in human aortic endothelial cells. *Eur. J. Pharmacol.* **288**: 131–137, 1995.
- HOSOYA, N., MITSUI, M., YAZAMA, F., ISHIHARA, H., OZAKI, H., KARAKI, H., HARTSHORNE, D. J., AND MOHRI, H.: Changes in the cytoskeletal structure of cultured smooth muscle cells induced by calyculin-A. *J. Cell Sci.* **105**: 883–890, 1993.
- HU, Q. H., AND WANG, D. X.: Both hypoxic endothelial cell conditioned medium and hypoxia elevate intracellular free calcium in pulmonary artery smooth muscle cells. *J. Tongji Med. Univ.* **14**: 200–203, 1994.
- HUANG, S., SIMONSON, M. S., AND DUNN, M. J.: Manidipine inhibits endothelin-1-induced $[\text{Ca}^{2+}]_i$ signaling but potentiates endothelin's effect on c-fos and c-jun induction in vascular smooth muscle and glomerular mesangial cells. *Am. Heart J.* **125**: 589–597, 1993.
- HUANG, X. -N., HISAYAMA, T., AND TAKAYANAGI, I.: Endothelin-1 induced contraction of rat aorta: contributions made by Ca^{2+} influx and activation of contractile apparatus associated with no change in cytoplasmic Ca^{2+} level. *Naunyn-Schmiedeberg's Arch. Pharmacol.* **341**: 80–87, 1990a.
- HUANG, X. -N., TAKAYANAGI, I., AND HISAYAMA, T.: Endothelin-1 induced contraction of rat aorta in Ca^{2+} free medium independent of phosphatidylinositol 4,5-bisphosphate (PIP_2) breakdown. *Gen. Pharmacol.* **21**: 893–898, 1990b.
- HUDGINS, P. M., AND WEISS, G. B.: Differential effects of calcium removal upon vascular smooth muscle contraction induced by norepinephrine, histamine and potassium. *J. Pharmacol. Exp. Ther.* **159**: 91–97, 1968.
- HUGHES, A. D.: Increase in tone and intracellular Ca^{2+} in rabbit isolated ear artery by platelet-derived growth factor. *Br. J. Pharmacol.* **114**: 138–142, 1995.
- HUGHES, A. D., HERING, S., AND BOLTON, T. B.: The action of caffeine on inward barium current through voltage-dependent calcium channels in single rabbit ear artery cells. *Pfluegers Arch.* **416**: 462–466, 1990.
- HUGHES, A. D., AND SCHACHTER, M.: Multiple pathways for entry of calcium and other divalent cations in vascular smooth muscle cell line (A7r5). *Cell Calcium* **15**: 317–330, 1994.
- HUME, J. R., AND LEBLANC, N.: Macroscopic K^+ currents in single smooth muscle cells of the rabbit portal vein. *J. Physiol. (Lond.)* **413**: 49–73, 1989.
- HWANG, K. S., AND VAN-BREEMEN, C.: Ryanodine modulation of calcium-45 efflux and tension in rabbit aortic smooth muscle. *Pfluegers Arch.* **408**: 343–350, 1987.
- IAIZZO, P. A.: The effects of halothane and isoflurane on intracellular Ca^{2+} regulation in cultured cells with characteristics of vascular smooth muscle. *Cell Calcium* **13**: 513–520, 1992.
- ICHIKAWA, K., ITO, M., AND HARTSHORNE, D. J.: Phosphorylation of the large subunit of myosin phosphatase and inhibition of phosphatase activity. *J. Biol. Chem.* **271**: 4733–4740, 1996.
- ICHIKAWA, K., ITO, M., OKUBO, S., KONISHI, T., NAKANO, T., MINO, T., NAKAMURA, F., NAKA, M., AND TANAKA, T.: Calponin phosphatase from smooth muscle: a possible role of type 1 protein phosphatase in smooth muscle relaxation. *Biochem. Biophys. Res. Commun.* **193**: 827–833, 1993.
- IESAKI, T., OKADA, T., SHIMADA, I., YAMAGUCHI, H., AND OCHI, R.: Decrease in Ca^{2+} sensitivity as a mechanism of hydrogen peroxide-induced relaxation of rabbit aorta. *Cardiovasc. Res.* **31**: 820–825, 1996.
- IGNARRO, L. J.: Biological actions and properties of endothelium-derived nitric oxide formed and released from artery and vein. *Circ. Res.* **65**: 1–21, 1989.
- IGNARRO, L. J., AND KADOWITZ, P. J.: The pharmacological and physiological role of cyclic GMP in vascular smooth muscle relaxation. *Ann. Rev. Pharmacol. Toxicol.* **25**: 171–191, 1985.
- IJIMA, K., LIN, L., NASJLETTI, A., AND GOLIGORSKY, M. S.: Intracellular signaling pathway of endothelin-1. *J. Cardiovasc. Pharmacol.* **17**: S146–S149, 1991.
- IINO, M.: Calcium-dependent inositol trisphosphate-induced calcium release in the guinea-pig *taenia caeci*. *Biochem. Biophys. Res. Commun.* **142**: 47–52, 1987.
- IINO, M.: Calcium-induced calcium release mechanism in guinea pig *taenia caeci*. *J. Gen. Physiol.* **94**: 363–383, 1989.
- IINO, M.: Biphasic Ca^{2+} dependence of inositol 1,4,5-trisphosphate-induced Ca^{2+} release in smooth muscle cells of the guinea pig *taenia caeci*. *J. Gen. Physiol.* **95**: 1103–1122, 1990.
- IINO, M., AND ENDO, M.: Calcium-dependent immediate feedback control of inositol 1,4,5-trisphosphate-induced Ca^{2+} release. *Nature (Lond.)* **360**: 76–78, 1992.
- IINO, M., KASAI, H., AND YAMAZAWA, T.: Visualization of neural control of intracellular Ca^{2+} concentration in single vascular smooth muscle cells in situ. *EMBO J.* **13**: 5026–5031, 1994a.
- IINO, M., KOBAYASHI, T., AND ENDO, M.: Use of ryanodine for functional removal of the calcium store in smooth muscle cells of the guinea-pig. *Biochem. Biophys. Res. Commun.* **152**: 417–422, 1988.
- IINO, M., AND TSUKIOKA, M.: Feedback control of inositol trisphosphate signaling by calcium. *Mol. Cell Endocrinol.* **98**: 141–146, 1994.
- IINO, M., YAMAZAWA, T., MIYASHITA, Y., ENDO, M., AND KASAI, H.: Critical intracellular Ca^{2+} concentration for all-or-none Ca^{2+} spiking in single smooth muscle cells. *EMBO J.* **12**: 5287–5291, 1993.
- IINO, S., HAYASHI, H., SAITO, H., TOKUNO, H., AND TOMITA, T.: Effects of intracellular pH on calcium currents and intracellular calcium ions in the smooth muscle of rabbit portal vein. *Exp. Physiol.* **79**: 669–680, 1994b.
- IMAI, S., YOSHIDA, Y., AND SUN, H. T.: Sarcolemmal ($\text{Ca}^{2+} + \text{Mg}^{2+}$)-ATPase of vascular smooth muscle and the effects of protein kinases thereupon. *J. Biochem.* **107**: 755–761, 1990.
- IMAIZUMI, Y., HENMI, H., UYAMA, Y., WATANABE, M., AND OHIZUMI, Y.: Effects of 9-methyl-7-bromoedustomin D (MBED), a powerful Ca^{2+} releaser, on smooth muscles of the guinea pig. *Ann. N. Y. Acad. Sci.* **707**: 546–549, 1993.
- IMAIZUMI, Y., HENMI, S., NAGANO, N., MURAKI, K., AND WATANABE, M.: Regulation of Ca-dependent K current and action potential shape by intracellular Ca storage sites in some types of smooth muscle cells. In *Smooth Muscle Excitation*, ed. by T. B. Bolton and T. Tomita, pp. 337–354, Academic Press, 1996a.
- IMAIZUMI, Y., HENMI, S., UYAMA, K., ATSUKI, Y., OHIZUMI, Y., AND WATANABE, M.: Characteristics of Ca^{2+} release for activation of K^+ current and contractile system in some smooth muscles. *Am. J. Physiol.* **271**: C772–C782, 1996b.
- IMAIZUMI, Y., TAKEDA, M., MURAKI, K., AND WATANABE, M.: Mechanisms of NE-induced reduction of Ca current in single smooth muscle cells from guinea pig vas deferens. *Am. J. Physiol.* **260**: C17–C25, 1991.
- INATOMI, N., TAKAYANAGI, I., AND TAKAGI, K.: Antiphosphodiesterase activity and nonspecific smooth muscle relaxation tested on intestinal smooth muscles. *Jpn. J. Pharmacol.* **25**: 63–69, 1975.
- INOBUCHI, T., BATTAN, R., HANDLER, E., SPORTSMAN, J. R., HEATH, W., AND KING, G. L.: Preferential elevation of protein kinase C isoform β II and diacylglycerol levels in the aorta and heart of diabetic rats: differential reversibility to glycemic control by islet cell transplantation. *Proc. Natl. Acad. Sci. USA* **89**: 11059–11063, 1992.
- INOUE, R., AND CHEN, S.: Physiology of muscarinic receptor-operated nonselective cation channels in guinea-pig ileal smooth muscle. In *Nonselective Cation Channels: Pharmacology, Physiology, and Biophysics*, ed. by D. Siemen, and J. Heschler, pp. 261–268, Birkhauser, Basel, 1993.
- IOUZALEN, L., DAVID-DUFILHO, M., AND DEVYNCK, M. A.: Refilling state of internal Ca^{2+} stores is not the only intracellular signal stimulating Ca^{2+} influx in human endothelial cells. *Biochem. Pharmacol.* **49**: 893–899, 1995.
- ISHIDA, Y., RIESINGER, I., WALLIMANN, T., AND PAUL, R. J.: Compartmentation of ATP synthesis and utilization in smooth muscle: roles of aerobic glycolysis and creatine kinase. *Mol. Cell. Biochem.* **133/134**: 39–50, 1994.
- ISHIHARA, H., AND KARAKI, H.: Inhibitory effect of 8-(*n*, *n*-diethylamino)octyl-3,4,5-trimethoxybenzoate (TMB-8) in vascular smooth muscle. *Eur. J. Pharmacol.* **197**: 181–186, 1991.
- ISHIHARA, H., MARTIN, B. L., BRAUTIGAN, D. L., KARAKI, H., OZAKI, H., KATO, Y., FUSEYANI, N., WATABE, S., HASHIMOTO, K., UEMURA, D., AND HARTSHORNE, D. V.: Calyculin A and okadaic acid: inhibitors of protein phosphatase activity. *Biochem. Biophys. Res. Commun.* **159**: 871–877, 1989a.
- ISHIHARA, H., OZAKI, H., SATO, K., HORI, M., KARAKI, H., WATABE, S., KATO, Y., FUSEYANI, N., HASHIMOTO, K., UEMURA, D., AND HARTSHORNE, D. V.: Calcium-independent activation of contractile apparatus in smooth muscle by calyculin-A. *J. Pharmacol. Exp. Ther.* **250**: 388–396, 1989b.
- ISHIKAWA, T., CHJIWA, T., HAGIWARA, M., MAMIYA, S., SAITOH, M., AND HIDAKA, H.: ML-9 inhibits the vascular contraction via the inhibition of myosin light chain phosphorylation. *Mol. Pharmacol.* **33**: 598–603, 1988.
- ISHIKAWA, T., AND HIDAKA, H.: Molecular pharmacology of calcium, calmodulin-dependent myosin phosphorylation in vascular smooth muscle. *Am. J. Hypertens.* **3**: 231S–234S, 1990.
- ISHIKAWA, M., OUCHI, Y., HAN, S. Z., AKISHITA, M., KOZAKI, K., TOBA, K., NAMIKI, A., YAMAGUCHI, T., AND ORIMO, H.: Parathyroid hormone-related protein reduces cytosolic free Ca^{2+} level and tension in rat aortic smooth muscle. *Eur. J. Pharmacol.* **269**: 311–317, 1994.
- ISHIKAWA, M., OUCHI, Y., AND ORIMO, H.: Effect of calcitonin gene-related peptide on cytosolic free Ca^{2+} level in vascular smooth muscle. *Eur. J. Pharmacol.* **246**: 121–128, 1993.
- ISLAM, M. O., YOSHIDA, Y., KOGA, T., KOJIMA, M., KANGAWA, K., AND IMAI, S.:

- Isolation and characterization of vascular smooth muscle inositol 1,4,5-trisphosphate receptor. *Biochem. J.* **316**: 295–302, 1996.
- ITAGAKI, M., KOMORI, S., UNNO, T., SYUTO, B., AND OHASHI, H.: Possible involvement of a small G-protein sensitive to exoenzyme C3 of *Clostridium botulinum* in the regulation of myofilament Ca^{2+} sensitivity in β -escin skinned smooth muscle of guinea pig ileum. *Jpn. J. Pharmacol.* **67**: 1–7, 1995.
- ITO, K., IKEMOTO, T., AOKI, S., AND OTA, M.: Effects of ryanodine and 9,21-didehydroryanodine on caffeine-induced contraction of rat and guinea aortae. *Jpn. J. Pharmacol.* **51**: 531–538, 1989.
- ITO, K., IKEMOTO, T., AND TAKAKURA, S.: Involvement of Ca^{2+} influx-induced Ca^{2+} release in contractions of intact vascular smooth muscles. *Am. J. Physiol.* **261**: H1464–H1470, 1991a.
- ITO, K., TAKAKURA, S., SATO, K., AND SUTKO, J. L.: Ryanodine inhibits the release of calcium from intracellular stores in guinea pig aortic smooth muscle. *Circ. Res.* **58**: 730–734, 1986.
- ITO, S., KAJIKURI, J., ITOH, T., AND KURIYAMA, H.: Effects of lemakalim on changes in Ca^{2+} concentration and mechanical activity induced by noradrenaline in the rabbit mesenteric artery. *Br. J. Pharmacol.* **104**: 227–233, 1991b.
- ITO, Y., AND KURIYAMA, H.: Caffeine and excitation-contraction coupling in the guinea pig taenia coli. *J. Gen. Physiol.* **57**: 448–463, 1971.
- ITO, Y., KURIYAMA, H., AND PARKER, I.: Calcium transients evoked by electrical stimulation of smooth muscle from guinea-pig ileum recorded by the use of Fura-2. *J. Physiol. (Lond.)* **407**: 117–134, 1988.
- ITO, Y., TAKAGI, K., AND TOMITA, T.: Relaxant actions of isoprenaline on guinea-pig isolated tracheal smooth muscle. *Br. J. Pharmacol.* **116**: 2738–2742, 1995.
- ITOH, H., SHIMAMURA, A., OKUBO, S., ICHIKAWA, K., ITO, M., KONISHI, T., AND NAKANO, T.: Inhibition of myosin light chain phosphatase during Ca^{2+} -independent vasoconstriction. *Am. J. Physiol.* **265**: C1319–C1324, 1993.
- ITOH, T., KURIYAMA, H., AND SUZUKI, H.: Excitation-contraction coupling in smooth muscle cells of the guinea-pig mesenteric artery. *J. Physiol. (Lond.)* **321**: 515–535, 1981.
- ITOH, T., ITO, S., SHAFIQ, J., AND SUZUKI, H.: Effects of a newly synthesized K^+ channel opener, Y-26763, on noradrenaline-induced Ca^{2+} mobilization in smooth muscle of the rabbit mesenteric artery. *Br. J. Pharmacol.* **111**: 165–172, 1994a.
- ITOH, T., KITAMURA, K., AND KURIYAMA, H.: Roles of extrajunctional receptors in the response of guinea-pig mesenteric and rat tail arteries to adrenergic nerves. *J. Physiol. (Lond.)* **345**: 409–422, 1983.
- ITOH, T., SEKI, N., SUZUKI, S., ITO, S., KAJIKURI, J., AND KURIYAMA, H.: Membrane hyperpolarization inhibits agonist-induced synthesis of inositol 1,4,5-trisphosphate in rabbit mesenteric artery. *J. Physiol. (Lond.)* **451**: 307–328, 1992.
- ITOH, T., SUZUKI, A., WATANABE, Y., NINO, T., NAKA, M., AND TANAKA, T.: A calponin peptide enhances Ca^{2+} sensitivity of smooth muscle contraction stimulated with endothelin-1. *Eur. J. Pharmacol.* **288**: 69–77, 1994b.
- ITOH, T., SUZUKI, S., AND KURIYAMA, H.: Effects of pinacidil on contractile proteins in high K^+ -treated intact, and in β -escin-treated skinned smooth muscle of the rabbit mesenteric artery. *Br. J. Pharmacol.* **103**: 1697–1702, 1991.
- ITOH, T., SUZUKI, S., AND WATANABE, Y.: Effect of a peptide inhibitor of protein kinase C on G-protein-mediated increase in myofilament Ca^{2+} -sensitivity in rabbit arterial skinned muscle. *Br. J. Pharmacol.* **111**: 311–317, 1994c.
- ITOH, T., SUZUKI, S., SUZUKI, A., NAKAMURA, F., NAKA, M., AND TANAKA, T.: Effects of exogenously applied calponin on Ca^{2+} -regulated force in skinned smooth muscle of the rabbit mesenteric artery. *Pfluegers Arch.* **427**: 301–308, 1994d.
- IWAMOTO, T., HARADA, K., NAKAJIMA, F., AND SUKAMOTO, T.: Effects of ouabain on muscle tension and intracellular Ca^{2+} level in guinea-pig aorta. *Eur. J. Pharmacol.* **224**: 71–76, 1992.
- IWAMOTO, T., NISHIMURA, N., MORITA, T., AND SUKAMOTO, T.: Differential vasorelaxant effects of K^+ -channel openers and Ca^{2+} -channel blockers on canine isolated arteries. *J. Pharm. Pharmacol.* **45**: 292–297, 1993.
- JACOB, R.: Agonist-stimulated divalent cation entry into single cultured human umbilical vein endothelial cells. *J. Physiol. (Lond.)* **421**: 55–77, 1990.
- JAFFE, L. F.: Classes and mechanisms of calcium waves. *Cell Calcium* **14**: 736–745, 1993.
- JAHAN, H., KOBAYASHI, S., NISHIMURA, J., AND KANAIDE, H.: Endothelin-1 and angiotensin II act as progression but not competence growth factors in vascular smooth muscle cells. *Eur. J. Pharmacol.* **295**: 261–269, 1996.
- JENSEN, P. E., GONG, M. C., SOMLYO, A. V., AND SOMLYO, A. P.: Separate upstream and convergent downstream pathway of G-protein- and phorbol ester-mediated Ca^{2+} sensitization of myosin light chain phosphorylation in smooth muscle. *Biochem. J.* **318**: 469–475, 1996.
- JIANG, M. J., CHAN, C. F., AND CHANG, Y. L.: Intracellular calcium and myosin light chain phosphorylation during U46619-activated vascular contraction. *Life Sci.* **54**: 2005–2013, 1994.
- JIANG, H., COLBRAN, J. L., FRANCIS, S. H., AND CORBIN, J. D.: Direct evidence for cross-activation of cGMP-dependent protein kinase by cAMP in pig coronary arteries. *J. Biol. Chem.* **267**: 1015–1019, 1992.
- JIANG, M. J., AND MORGAN, K. G.: Intracellular calcium levels in phorbol ester-induced contractions of vascular muscle. *Am. J. Physiol.* **253**: H1365–H1371, 1987.
- JIANG, M. J., AND MORGAN, K. G.: Agonist-specific myosin phosphorylation and intracellular calcium during isometric contractions of arterial smooth muscle. *Pfluegers Arch.* **413**: 637–643, 1989.
- JOHNSON, M. E., THELER, J. -M., CAPPONI, A. M., AND VALLOTTON, M. B.: Characterization of oscillations in cytosolic free Ca^{2+} concentration and measurement of cytosolic Na^+ concentration changes evoked by angiotensin II and vasopressin in individual rat aortic smooth muscle cells. *J. Biol. Chem.* **266**: 12618–12626, 1991.
- JONES, K. A., HOUSMANS, P. R., WARNER, D. O., LORENZ, R. R., AND REHDER, K.: Halothane alters cytosolic calcium transient in tracheal smooth muscle. *Am. J. Physiol.* **265**: L80–L86, 1993.
- JONES, K. A., LORENZ, R. R., MORIMOTO, N., SIECK, G. C., AND WARNER, D. O.: Halothane reduces force and intracellular Ca^{2+} in airway smooth muscle independently of cyclic nucleotides. *Am. J. Physiol.* **268**: L166–L172, 1995.
- JONES, K. A., LORENZ, R. R., WARNER, D. O., KATUSIC, Z. S., AND SIECK, G. C.: Changes in cytosolic cGMP and calcium in airway smooth muscle relaxed by 3-morpholinolysynonimine. *Am. J. Physiol.* **266**: L9–L16, 1994.
- JULOU-SCHAEFFER, G., AND FRESLON, J. L.: Effects of ryanodine on tension development in rat aorta and mesenteric resistance vessels. *Br. J. Pharmacol.* **95**: 605–613, 1988.
- KAGEYAMA, M., MORI, T., YANAGISAWA, T., AND TAIRA, N.: Is staurosporine a specific inhibitor of protein kinase C in intact porcine coronary arteries? *J. Pharmacol. Exp. Ther.* **259**: 1019–1026, 1991.
- KAGEYAMA, M., YANAGISAWA, T., AND TAIRA, N.: Calcitonin gene-related peptide relaxes porcine coronary arteries via cyclic AMP-dependent mechanisms, but not activation of ATP-sensitive potassium channels. *J. Pharmacol. Exp. Ther.* **265**: 490–497, 1993.
- KAGEYAMA, M., YANAGISAWA, T., AND TAIRA, N.: Effects of semotiadil fumarate, a novel Ca^{2+} antagonist, on cytosolic Ca^{2+} level and force of contraction in porcine coronary arteries. *Br. J. Pharmacol.* **114**: 1289–1295, 1995.
- KAHN, A. M., ALLEN, J. C., SEIDEL, C. L., AND SONG, T.: Insulin inhibits serotonin-induced Ca^{2+} influx in vascular smooth muscle. *Circulation* **90**: 384–390, 1994.
- KAHN, A. M., LICHTENBERG, R. A., ALLEN, J. C., SEIDEL, C. L., AND SONG, T.: Insulin-stimulated glucose transport inhibits Ca^{2+} influx and contraction in vascular smooth muscle. *Circulation* **92**: 1597–1603, 1995.
- KAHN, A. M., SEIDEL, C. L., ALLEN, J. C., O'NEIL, R. G., SHELAT, H., AND SONG, T.: Insulin reduces contraction and intracellular calcium concentration in vascular smooth muscle. *Hypertension* **22**: 735–742, 1993.
- KAI, H., KANAIDE, H., MATSUMOTO, T., AND NAKAMURA, M.: 8-Bromoguanosine 3':5'-cyclic monophosphate decreases intracellular free calcium concentrations in cultured vascular smooth muscle cells from rat aorta. *FEBS Lett.* **221**: 284–288, 1987.
- KAI, H., KANAIDE, H., AND NAKAMURA, M.: Endothelin-sensitive intracellular Ca^{2+} store overlaps with caffeine-sensitive one in rat aortic smooth muscle cells in primary cultures. *Biochem. Biophys. Res. Commun.* **158**: 235–243, 1989.
- KAI, T., NISHIMURA, J., KOBAYASHI, S., TAKAHASHI, S., YOSHITAKE, J., AND KANAIDE, H.: Effects of lidocaine on intracellular Ca^{2+} and tension in airway smooth muscle. *Anesthesiology* **78**: 954–965, 1993.
- KAJIKURI, J., AND KURIYAMA, H.: Inhibitory action of α -human atrial natriuretic peptide on noradrenaline-induced synthesis of myo-inositol 1,4,5-trisphosphate in the smooth muscle cells of rabbit aorta. *Br. J. Pharmacol.* **99**: 536–540, 1990.
- KAKUYAMA, M., HATANO, Y., NAKAMURA, K., TODA, H., TERASAKO, K., NISHIWADA, M., AND MORI, K.: Halothane and enflurane constrict canine mesenteric arteries by releasing Ca^{2+} from intracellular Ca^{2+} stores. *Anesthesiology* **80**: 1120–1127, 1994.
- KALSNER, S., NICKERSON, M., AND BOYD, G. N.: Selective blockade of potassium-induced contractions of aortic strips by b-diethylaminoethyl-diphenyl-propylacetate (SKF 525A). *J. Pharmacol. Exp. Ther.* **174**: 500–508, 1970.
- KALTHOF, B., BECHEM, M., FLOCKE, K., POTT, L., AND SCHRAMM, M.: Kinetics of ATP-induced Ca^{2+} transients in cultured pig aortic smooth muscle cells depend on ATP concentration and stored Ca^{2+} . *J. Physiol. (Lond.)* **466**: 245–262, 1993.
- KAMISHIMA, T., NELSON, M. T., AND PATLAK, J. B.: Carbachol modulates voltage sensitivity of calcium channels in bronchial smooth muscle of rats. *Am. J. Physiol.* **263**: C69–C77, 1992.
- KAMM, K. E., AND GRANGE, R. W.: Calcium sensitivity of contraction. In *Biochemistry of Smooth Muscle Contraction*, ed. by M. Barany, pp. 355–365, Academic Press, New York, 1996.
- KAMM, K. E., AND STULL, J. T.: The function of myosin and myosin light chain kinase phosphorylation in smooth muscle. *Ann. Rev. Pharmacol. Toxicol.* **25**: 593–620, 1985.
- KAMM, K. E., AND STULL, J. T.: Regulation of smooth muscle contractile elements by second messenger. *Ann. Rev. Physiol.* **51**: 299–313, 1989.
- KANAI, A. J., STRAUSS, H. C., TRUSKEY, G. A., CREWS, A. L., GRUNFELD, S., AND MALINSKI, T.: Shear stress induces ATP-independent transient nitric oxide release from vascular endothelial cells, measured directly with a porphyrinic microsensor. *Circ. Res.* **77**: 284–293, 1995.
- KANEDA, T., SHIMIZU, K., NAKAJYO, S., AND URAKAWA, N.: Effect of phorbol ester, 12-deoxyphorbol 13-isobutylate (DPB), on muscle tension and cytosolic Ca^{2+} in rat aortic smooth muscle. *Jpn. J. Pharmacol.* **69**: 195–204, 1995.
- KANG, T. M., SO, I., AND KIM, K. W.: Caffeine- and histamine-induced oscillations

- tions of K_{Ca} current in single smooth muscle cells of rabbit cerebral artery. *Pfluegers Arch.* **431**: 91–100, 1995.
- KANMURA, Y., MISSIAEN, L., RAEYMAEKERS, L., AND CASTEELS, R.: Ryanodine reduces the amount of calcium in intracellular stores of smooth-muscle cells of the rabbit ear artery. *Pfluegers Arch.* **413**: 153–159, 1988.
- KAPLAN, N., AND DI SALVO, J.: Coupling between [arginine⁸¹]-vasopressin-activated increases in protein tyrosine phosphorylation and cellular calcium in A7r5 aortic smooth muscle cells. *Arch. Biochem. Biophys.* **326**: 271–280, 1996.
- KARAKI, H.: Use of tension response to delineate the modes of action of vasodilators. *J. Pharmacol. Method* **18**: 1–21, 1987.
- KARAKI, H.: Ca^{2+} localization and sensitivity in vascular smooth muscle. *Trends Pharmacol. Sci.* **10**: 320–325, 1989a.
- KARAKI, H.: Magnesium as a modifier of smooth muscle contractility. *Microcirc. Endothel. Lymphatics* **5**: 77–97, 1989b.
- KARAKI, H.: The intracellular calcium-force relationship in vascular smooth muscle. Time- and stimulus-dependent dissociation. *Am. J. Hypertension* **3**: 253S–256S, 1990.
- KARAKI, H.: Ca^{2+} regulation of vascular smooth muscle and release of endothelium-derived relaxing factor. In *Ion Channels of Vascular Smooth Muscle Cells and Endothelial Cells*, ed. by N. Sperelakis, and H. Kuriyama, pp. 297–315, Elsevier Science Publishing Co., New York, 1991.
- KARAKI, H.: Dual regulation of smooth muscle contraction. In *Regulation of the Contractile Cycle in Smooth Muscle*, ed. by T. Nakano, and D. J. Hartshorne, pp. 47–59, Springer, Tokyo, 1995a.
- KARAKI, H.: Regulation of smooth muscle: phosphorylation-dependent and independent mechanisms. In *Smooth Muscle Contraction, New Regulatory Modes*, ed. by K. Kohama and K. Saida, pp. 3–13, Jpn. Sci. Soc. Press, Karger, Tokyo, 1995b.
- KARAKI, H.: Smooth muscle contraction not dependent on myosin light chain phosphorylation. In *Calcium as Cell Signal*, ed. by K. Maruyama, Y. Nonomura, and K. Kohama, pp. 207–213, Igaku-Shoin, Tokyo, 1995c.
- KARAKI, H., ABE, F., MITSUI-SAITO, M., KITAJIMA, S., HARADA, K., HORI, M., SATO, K., OZAKI, H., AND ENDOH, M.: Two calcium compartments in vascular smooth muscle. In *Molecular and Cellular Mechanisms of Cardiovascular Regulation*, ed. by M. Endoh, M. Morad, H. Scholz, and T. Iijima, pp. 195–210, Springer, Tokyo, 1996.
- KARAKI, H., AHN, H. Y., AND URAKAWA, N.: Hyperosmotic applications of KCl induce vascular smooth muscle contraction which is independent of external Ca. *Jpn. J. Pharmacol.* **33**: 246–248, 1983.
- KARAKI, H., AHN, H. Y., AND URAKAWA, N.: Caffeine-induced contraction in vascular smooth muscle. *Arch. Int. Pharmacodyn. Ther.* **285**: 60–71, 1987.
- KARAKI, H., KUBOTA, H., AND URAKAWA, N.: Mobilization of stored calcium for phasic contraction by norepinephrine in rabbit aorta. *Eur. J. Pharmacol.* **56**: 237–245, 1979.
- KARAKI, H., AND MATSUDA, Y.: RES-701-1: a novel endothelin ET_B receptor antagonist. *Cardiovasc. Drug Rev.* **14**: 17–35, 1996.
- KARAKI, H., MITSUI, M., NAGASE, H., OZAKI, H., SHIBATA, S., AND UEMURA, D.: Inhibitory effect of a toxin okadaic acid, isolated from the black sponge on smooth muscle and platelets. *Br. J. Pharmacol.* **98**: 590–596, 1989.
- KARAKI, H., NAKAGAWA, H., AND URAKAWA, N.: Comparative effects of verapamil and sodium nitroprusside on contraction and ^{45}Ca uptake in the smooth muscle of rabbit aorta, rat aorta and guinea pig taenia coli. *Br. J. Pharmacol.* **81**: 393–400, 1984.
- KARAKI, H., OZAKI, H., AND URAKAWA, N.: Effect of ouabain and potassium-free solution on the contraction of isolated blood vessels. *Eur. J. Pharmacol.* **48**: 439–443, 1978.
- KARAKI, H., SATO, K., AND OZAKI, H.: Different effects of norepinephrine and KCl on the cytosolic Ca^{2+} -tension relationship in vascular smooth muscle of rat aorta. *Eur. J. Pharmacol.* **151**: 325–328, 1988a.
- KARAKI, H., SATO, K., AND OZAKI, H.: Different effects of verapamil on cytosolic Ca^{2+} and contraction in norepinephrine-stimulated vascular smooth muscle. *Jpn. J. Pharmacol.* **55**: 35–42, 1991.
- KARAKI, H., SATO, K., OZAKI, H., AND MURAKAMI, K.: Effects of sodium nitroprusside on cytosolic calcium level in vascular smooth muscle. *Eur. J. Pharmacol.* **156**: 259–266, 1988b.
- KARAKI, H., SUZUKI, T., OZAKI, H., URAKAWA, N., AND ISHIDA, Y.: Dissociation of K^+ -induced tension and cellular Ca^{++} retention in vascular and intestinal smooth muscle in normoxia and hypoxia. *Pfluegers Arch.* **394**: 118–123, 1982.
- KARAKI, H., AND URAKAWA, N.: A shift of cellular calcium to a more slowly exchangeable fraction during contraction in guinea pig taenia coli. *Jpn. J. Pharmacol.* **22**: 511–518, 1972.
- KARAKI, H., AND URAKAWA, N.: Possible role of endogenous catecholamines in the contraction induced in rabbit aorta by ouabain, sodium depletion and potassium depletion. *Eur. J. Pharmacol.* **43**: 65–72, 1977.
- KARAKI, H., AND WEISS, G. B.: Alterations in high and low affinity binding of ^{45}Ca in rabbit aortic smooth muscle by norepinephrine and potassium after exposure to lanthanum at low temperature. *J. Pharmacol. Exp. Ther.* **211**: 86–92, 1979.
- KARAKI, H., AND WEISS, G. B.: Dissociation of varied actions of norepinephrine on ^{45}Ca uptake and release at different sites in rabbit aortic smooth muscle. *J. Pharmacol. Exp. Ther.* **215**: 363–368, 1980a.
- KARAKI, H., AND WEISS, G. B.: Effects of stimulatory agents on mobilization of high and low affinity site $^{45}Ca^{2+}$ in rabbit aortic smooth muscle. *J. Pharmacol. Exp. Ther.* **213**: 450–455, 1980b.
- KARAKI, H., AND WEISS, G. B.: Quantitative differences in ^{45}Ca efflux from membrane sites in vascular smooth muscle when washout conditions are varied. *Gen. Pharmacol.* **11**: 483–489, 1980c.
- KARAKI, H., AND WEISS, G. B.: Effects of transmembrane pH gradient changes on potassium-induced relaxation in vascular smooth muscle. *Blood Vessels.* **18**: 36–44, 1981a.
- KARAKI, H., AND WEISS, G. B.: Inhibitors of mitochondrial Ca^{++} uptake dissociate aortic smooth muscle. *Blood Vessels.* **18**: 28–35, 1981b.
- KARAKI, H., AND WEISS, G. B.: Calcium channels in smooth muscle. *Gastroenterology* **87**: 960–970, 1984.
- KARAKI, H., AND WEISS, G. B.: Modification by decreased temperature and hypoxia of ^{45}Ca movements in stimulated smooth muscle of rabbit aorta. *Gen. Pharmacol.* **18**: 363–368, 1987.
- KARAKI, H., AND WEISS, G. B.: Calcium release in smooth muscle. *Life Sci.* **42**: 111–122, 1988.
- KARGACIN, G. J.: Calcium signaling in restricted diffusion spaces. *Biophys. J.* **67**: 262–272, 1994.
- KARGACIN, G., AND FAY, F. S.: Ca^{2+} movement in smooth muscle cells studied with one- and two-dimensional diffusion models. *Biophys. J.* **60**: 1088–1100, 1991.
- KASAI, Y., IINO, M., TSUTSUMI, O., TAKETANI, Y., AND ENDO, M.: Effects of cyclopiazonic acid on rhythmic contractions in uterine smooth muscle bundles of the rat. *Br. J. Pharmacol.* **112**: 1132–1136, 1994.
- KASUYA, Y., TAKUWA, Y., YANAGISAWA, M., MASAKI, T., AND GOTO, K.: A pertussis toxin-sensitive mechanism of endothelin action in porcine coronary artery smooth muscle. *Br. J. Pharmacol.* **107**: 456–462, 1992.
- KATO, Y., FUSEYANI, N., MATSUNAGA, S., AND HASHIMOTO, K.: Calyculin A, a novel antitumor metabolite from marine sponge *Discodermia calyx*. *J. Am. Chem. Soc.* **108**: 2780–2781, 1986.
- KATSUKI, S., ARNOLD, W., MITTAL, C., AND MURAD, F.: Stimulation of guanylate cyclase by sodium nitroprusside, nitroglycerine and nitric oxide in various tissue preparations and comparison to the effects of sodium azide and hydroxylamine. *J. Cyclic Nucleotide Res.* **3**: 23–35, 1977.
- KATSUYAMA, H., ITO, S., ITOH, T., AND KURIYAMA, H.: Effects of ryanodine on acetylcholine-induced Ca^{2+} mobilization in single smooth muscle cells of the porcine coronary artery. *Pfluegers Arch.* **419**: 460–466, 1991.
- KATSUYAMA, H., AND MORGAN, K. G.: Mechanisms of Ca^{2+} -independent contraction in single permeabilized ferret aorta cells. *Circ. Res.* **72**: 651–657, 1993.
- KAWADA, T., TOYOSATO, A., ISLAM, M. O., YOSHIDA, Y., AND IMAI, S.: cGMP-kinase mediates cGMP- and cAMP-induced Ca^{2+} desensitization of skinned artery. *Eur. J. Pharmacol.* **323**: 75–82, 1997.
- KAWANISHI, T., KAWANISHI, M., OHATA, H., TOYODA, K., TAKAHASHI, M., MOMOSE, K., AND HAYASHI, Y.: The relationship between spontaneous calcium oscillations and cell proliferation in cultured smooth muscle cells. *Jpn. J. Pharmacol.* **65**: 59–62, 1994.
- KAWASE, T., AND VAN BREEMEN, C.: Aluminum fluoride induces a reversible Ca^{2+} sensitization in α -toxin-permeabilized vascular smooth muscle. *Eur. J. Pharmacol.* **214**: 39–44, 1992.
- KERRICK, W. G., AND HOAR, P. E.: Relationship between ATPase activity, Ca^{2+} and force in α -toxin and β -escin-treated smooth muscle. *Can. J. Physiol. Pharmacol.* **72**: 1361–1367, 1994.
- KHALIL, R. A., LAJOIE, C., AND MORGAN, K. G.: In situ determination of $[Ca^{2+}]_i$ threshold for translocation of the α -protein kinase C isoform. *Am. J. Physiol.* **266**: C1544–C1551, 1994.
- KHALIL, R. A., LAJOIE, C., RESNICK, M. S., AND MORGAN, K. G.: Ca^{2+} independent isoforms of protein kinase C differentially translocate in smooth muscle. *Am. J. Physiol.* **263**: C714–C719, 1992.
- KHALIL, R. A., AND MORGAN, K. G.: PKC-mediated redistribution of mitogen-activated protein kinase during muscle cell activation. *Am. J. Physiol.* **265**: C406–C411, 1993.
- KHOYI, M. A., BJUR, R. A., AND WESTFALL, D. P.: Norepinephrine increases Na^+ - Ca^{2+} exchange in rabbit abdominal aorta. *Am. J. Physiol.* **261**: C685–C690, 1991.
- KIM, N. N., KIM, J. J., HYPOLITE, J., GARCIA-DIAZ, J. F., BRODERICK, G. A., TORNHEIM, K., DALEY, J. T., LEVIN, R., AND SAENZ DE TEJADA, I.: Altered contractility of rabbit penile corpus cavernosum smooth muscle by hypoxia. *J. Urol.* **155**: 772–778, 1996a.
- KIM, B. K., MITSUI, M., AND KARAKI, H.: The long-term inhibitory effect of a Ca^{2+} channel blocker, nisoldipine, on cytosolic Ca^{2+} and contraction in vascular smooth muscle. *Eur. J. Pharmacol.* **223**: 157–162, 1992.
- KIM, B.-K., OZAKI, H., HORI, M., AND KARAKI, H.: Increased inhibitory effect of phorbol ester on cytosolic Ca^{2+} level and contraction in rat myometrium after gestation. *Jpn. J. Pharmacol.* **72**: 111–118, 1996b.
- KIM, B. K., OZAKI, H., LEE, S. M., AND KARAKI, H.: Increased sensitivity of rat myometrium to contractile effect of platelet activating factor before delivery. *Br. J. Pharmacol.* **115**: 1211–1214, 1995a.
- KIM, H. Y., THOMAS, D., AND HANLEY, R.: Chromatographic resolution of an intracellular calcium influx factor from thapsigargin-activated Jurkat cells. *J. Biol. Chem.* **270**: 9706–9708, 1995b.
- KIM, Y. C., AND ZEMEL, M. B.: Insulin increases vascular smooth muscle recovery from intracellular calcium loads. *Hypertension* **22**: 74–77, 1993.
- KIMURA, K., ITO, M., AMANO, M., CHIHARA, K., FUKATA, Y., NAKAFUKU, M.,

- YAMAMORI, B., FENG, J., NAKANO, T., OKAWA, K., IWAMATSU, A., AND KAIBUCHI, K.: Regulation of myosin phosphatase by rho and rho-associated kinase (rho-kinase). *Science (Wash DC)*. **273**: 245–248, 1996.
- KISHII, K., INAZU, M., MORIMOTO, T., TSUJITANI, M., AND TAKAYANAGI, I.: Effects of LP-805, a new vasodilating agent, on cytosolic Ca^{2+} and contraction in vascular smooth muscle of rat aorta. *Gen. Pharmacol.* **23**: 355–363, 1992.
- KITAJIMA, S., HARADA, K., HORI, M., OZAKI, H., AND KARAKI, H.: Dissociation of P_2 purinoceptor-mediated increase in intracellular Ca^{2+} level from myosin light chain phosphorylation and contraction in rat aorta. *Br. J. Pharmacol.* **118**: 543–548, 1996a.
- KITAJIMA, S., OZAKI, H., AND KARAKI, H.: The effects of ATP and (α , β -methylene-ATP on cytosolic Ca^{2+} level and force in isolated rat aorta. *Br. J. Pharmacol.* **110**: 263–268, 1993.
- KITAJIMA, S., OZAKI, H., AND KARAKI, H.: Role of different subtypes of P_2 purinoceptor on cytosolic Ca^{2+} levels in rat aortic smooth muscle. *Eur. J. Pharmacol.* **266**: 263–267, 1994.
- KITAJIMA, S., OZAKI, H., AND KARAKI, H.: Effects of acidosis on cytosolic Ca^{2+} level, Ca^{2+} sensitivity and force in vascular smooth muscle. *In* Smooth Muscle Excitation, ed. by T. Bolton and T. Tomita, pp. 291–302, Academic Press, London, 1996b.
- KITAMURA, K., KANGAWA, K., KAWAMOTO, M., ICHIKI, Y., NAKAMURA, S., MATSUO, H., AND ETO, T.: Adrenomedullin: a novel hypotensive peptide isolated from human pheochromocytoma. *Biochem. Biophys. Res. Commun.* **192**: 553–560, 1993.
- KITAMURA, K., SAKAI, T., KAJIJO, S., AND KURIYAMA, H.: Activations of the Ca dependent K channel by Ca released from the sarcoplasmic reticulum of mammalian smooth muscles. *Biomed. Biochim. Acta* **48**: S364–S369, 1989.
- KITAZAWA, T., GAYLINN, B. D., DENNY, G. H., AND SOMLYO, A. P.: G-protein-mediated Ca^{2+} sensitization of smooth muscle contraction through myosin light chain phosphorylation. *J. Biol. Chem.* **266**: 1708–1715, 1991b.
- KITAZAWA, T., GAYLINN, B. D., AND SOMLYO, A. P.: G-protein mediated inhibition of myosin light chain phosphatase in vascular smooth muscle. *Proc. Natl. Acad. Sci. USA* **88**: 9307–9310, 1991a.
- KITAZAWA, T., KOBAYASHI, S., HORIUCHI, K., SOMLYO, A. V., AND SOMLYO, A. P.: Receptor-coupled, permeabilized smooth muscle. *J. Biol. Chem.* **264**: 5339–5342, 1989.
- KITAZAWA, T., LEE, M., ZHANG, M., MASUO, M., AND LI, L.: cGMP-induced Ca^{2+} desensitization of contraction and myosin light chain phosphorylation in permeabilized smooth muscle. *Biophys. J.* **70**: A383, 1996.
- KITAZONO, T., HEISTAD, D. D., AND FARACI, F. M.: Role of ATP-sensitive K^+ channels in CGRP-induced dilatation of basilar artery in vivo. *Am. J. Physiol.* **265**: H581–H585, 1993.
- KNOT, H. J., BRAYDEN, J. H., AND NELSON, M. T.: Calcium channels and potassium channels. *In* Biochemistry of Smooth Muscle Contraction, ed. by M. Barany, pp. 203–219, Academic Press, New York, 1996.
- KO, Y., TOTZKE, G., GRAACK, G. H., HEIDGEN, F. J., MEYER, F., BRICKWEDDE, M. K., DUSING, R., VETTER, H., AND SACHINIDIS, A.: Action of dihydropyridine calcium antagonists on early growth response gene expression and cell growth in vascular smooth muscle cells. *J. Hypertens.* **11**: 1171–1178, 1993.
- KOBAYASHI, S., KITAZAWA, T., SOMLYO, A. V., AND SOMLYO, A. P.: Cytosolic heparin inhibits muscarinic and α -adrenergic Ca^{2+} release in smooth muscle. Physiological role of inositol 1,4,5-trisphosphate in pharmacomechanical coupling. *J. Biol. Chem.* **264**: 17997–18004, 1989.
- KOBAYASHI, S., SOMLYO, A. V., AND SOMLYO, A. P.: Heparin inhibits the inositol 1,4,5-trisphosphate-dependent, but not the independent, calcium release induced by guanine nucleotide in vascular smooth muscle. *Biochem. Biophys. Res. Commun.* **153**: 625–631, 1988.
- KODAMA, M., YAMAMOTO, H., AND KANAIDE, H.: Myosin phosphorylation and Ca^{2+} sensitization in porcine coronary arterial smooth muscle stimulated with endothelin-1. *Eur. J. Pharmacol.* **288**: 69–77, 1994.
- KOH, E., MORIMOTO, S., TOMITA, J., RAKUGI, H., JIANG, B., INOUE, T., NABATA, T., FUKUO, K., AND OGIHARA, T.: Effects of an angiotensin II receptor antagonist, CV-11974, on angiotensin II-induced increases in cytosolic free calcium concentration, hyperplasia, and hypertrophy of cultured vascular smooth muscle cells. *J. Cardiovasc. Pharmacol.* **23**: 175–179, 1994.
- KOHAMA, K., HIRAMURA, T., TAKANO-OHMURO, H., OZAKI, H., KARAKI, H., AND HACHISU, M.: Effects of NA0344, a new smooth muscle relaxant, on the actin-myosin-ATP interaction and myosin light chain phosphorylation in vitro. *Gen. Pharmacol.* **22**: 465–474, 1991.
- KOHAMA, K., YE, L.-H., HAYAKAWA, K., AND OKAGAKI, T.: Myosin light chain kinase: an actin-binding protein that regulates and ATP-dependent interaction with myosin. *Trends Pharmacol. Sci.* **17**: 284–287, 1996.
- KOHD, M., KOMORI, S., UNNO, T., AND OHASHI, H.: Carbachol-induced $[Ca^{2+}]_i$ oscillations in single smooth muscle cells of guinea-pig ileum. *J. Physiol. (Lond.)* **492**: 315–328, 1996.
- KOJIMA, M., DOHI, Y., AND SATO, K.: Ryanodine-induced contraction in femoral artery from spontaneously hypertensive rats. *Eur. J. Pharmacol.* **254**: 159–165, 1994.
- KOKUBU, N., SATOH, M., AND TAKAYANAGI, I.: Involvement of botulinum C3-sensitive GTP-binding proteins in α_1 -adrenoceptor subtypes mediating Ca^{2+} sensitization. *Eur. J. Pharmacol.* **290**: 19–27, 1995.
- KOMORI, S., AND BOLTON, T. B.: Role of G-proteins in muscarinic receptor inward and outward currents in rabbit jejunal smooth muscle. *J. Physiol. (Lond.)* **427**: 395–419, 1990.
- KOMORI, S., ITAGAKI, M., UNNO, T., AND OHASHI, H.: Caffeine and carbachol act on common Ca^{2+} stores to release Ca^{2+} in guinea-pig ileal smooth muscle. *Eur. J. Pharmacol.* **277**: 173–180, 1995.
- KOMORI, S., IWATA, T., UNNO, T., AND OHASHI, H.: Modulation of carbachol-induced $[Ca^{2+}]_i$ oscillations by Ca^{2+} influx in single intestinal smooth muscle cells. *Br. J. Pharmacol.* **119**: 245–252, 1996.
- KOMORI, S., KAWAI, M., PACAUD, P., OHASHI, H., AND BOLTON, T. B.: Oscillations of receptor-operated cationic current and internal calcium in single guinea-pig ileal smooth muscle cells. *Pfluegers Arch.* **424**: 431–438, 1993.
- KONISHI, M., OLSON, A., HOLLINGWORTH, S., AND BAYLOR, S. M.: Myoplasmic binding of fura-2 investigated by steady-state fluorescence and absorbance measurements. *Biophys. J.* **54**: 1089–1104, 1988.
- KONNO, F., AND TAKAYANAGI, I.: Characterization of postsynaptic α_1 -adrenoceptors in the rabbit iris dilator smooth muscle. *Naunyn-Schmiedeberg's Arch. Pharmacol.* **333**: 271–276, 1986.
- KORENAGA, R., ANDO, J., OHTSUKA, A., SAKUMA, I., YANG, W., TOYO-OKA, T., AND KAMIYA, A.: Close correlation between cytoplasmic Ca^{++} levels and release of an endothelium-derived relaxing factor from cultured endothelial cells. *Cell Struct. Funct.* **18**: 95–104, 1993.
- KOTLIKOFF, M. I., AND KAMM, K. E.: Molecular mechanisms of β -adrenergic relaxation of airway smooth muscle. *Ann. Rev. Physiol.* **58**: 115–141, 1996.
- KOTLIKOFF, M. I., MURRAY, R. K., AND REYNOLDS, E. E.: Histamine-induced calcium release and phorbol antagonism in cultured airway smooth muscle cells. *Am. J. Physiol.* **253**: C561–C566, 1987.
- KOWARSKI, D., SHUMAN, H., SOMLYO, A. P., AND SOMLYO, A. V.: Calcium release by noradrenaline from central sarcoplasmic reticulum in rabbit main pulmonary artery smooth muscle. *J. Physiol.* **366**: 153–176, 1985.
- KRALL, J. F., FITTINGOF, F., AND MRAJFFER, J.: Characterization of cyclic nucleotide and inositol 1,4,5-trisphosphate-sensitive calcium-exchange activity of smooth muscle cells cultured from the human corpora cavernosa. *Biol. Reprod.* **39**: 913–922, 1988.
- KRAUTWURST, D., DEGTIAR, V. E., SCHULTZ, G., AND HESCHELER, J.: The isoquinoline derivative LOE 908 selectively blocks vasopressin-activated non-selective cation currents in A7r5 aortic smooth muscle cells. *Naunyn-Schmiedeberg's Arch. Pharmacol.* **349**: 301–307, 1994.
- KREMER, S. G., BREUER, W. V., AND SKORECKI, K. L.: Vasoconstrictor hormones depolarize renal glomerular mesangial cells by activating chloride channels. *J. Cell Physiol.* **138**: 97–105, 1989.
- KRUSE, H. J., BAURIEDL, G., HEIMERL, J., HOFLING, B., AND WEBER, P. C.: Role of L-type calcium channels on stimulated calcium influx and on proliferative activity of human coronary smooth muscle cells. *J. Cardiovasc. Pharmacol.* **24**: 328–335, 1994.
- KUBOTA, M., MOSELEY, J. M., BUTERA, L., DUSTING, G. J., MACDONALD, P. S., AND MARTIN, T. J.: Calcitonin gene-related peptide stimulates cyclic AMP formation in rat aortic smooth muscle cells. *Biochem. Biophys. Res. Commun.* **132**: 88–94, 1985.
- KUBOTA, Y., NOMURA, M., KAMM, K. E., MUMBY, M. C., AND STULL, J. T.: GTP γ S-dependent regulation of smooth muscle contractile elements. *Am. J. Physiol.* **262**: C405–410, 1992.
- KUGIYAMA, K., OHGUSHI, M., SUGIYAMA, S., MUROHARA, T., FUKUNAGA, K., MIYAMOTO, E., AND YASUE, H.: Lysophosphatidylcholine inhibits surface receptor-mediated intracellular signals in endothelial cells by a pathway involving protein kinase C activation. *Circ. Res.* **71**: 1422–1428, 1992.
- KUMASAKA, D., LINDEMAN, K. S., CLANCY, J., LANDE, B., AND CROXTON, T. L., AND HIRSHMAN, C. A.: $MgSO_4$ relaxes porcine airway smooth muscle by reducing Ca^{2+} entry. *Am. J. Physiol.* **270**: L469–L474, 1996.
- KUME, H., HALL, I. P., WASHABAU, R. J., TAKAGI, K., AND KOTLIKOFF, H. I.: β -adrenergic agonists regulates K_{Ca} channels in airway smooth muscle by cAMP-dependent and -independent mechanisms. *J. Clin. Invest.* **93**: 371–379, 1994.
- KUME, H., TAKAI, A., TOKUNO, H., AND TOMITA, T.: Regulation of Ca^{2+} -dependent K^+ -channel activity in tracheal myocytes by phosphorylation. *Nature (Lond.)* **341**: 152–154, 1989.
- KURATA, R., TAKAYANAGI, I., AND HISAYAMA, T.: Eicosanoid-induced Ca^{2+} release and sustained contraction in Ca^{2+} -free media are mediated by different signal transduction pathways in rat aorta. *Br. J. Pharmacol.* **110**: 875–881, 1993.
- KUREISHI, Y., KOBAYASHI, S., NISHIMURA, J., NAKANO, T., AND KANAIDE, H.: Adrenomedullin decreases both cytosolic Ca^{2+} concentration and Ca^{2+} -sensitivity in pig coronary arterial smooth muscle. *Biochem. Biophys. Res. Commun.* **212**: 572–579, 1995.
- KURIYAMA, H., KITAMURA, K., AND NABATA, H.: Pharmacological and physiological significance of ion channels and factors that modulate them in vascular tissues. *Pharmacol. Rev.* **47**: 387–573, 1995.
- KUROIWA, M., AOKI, H., KOBAYASHI, S., NISHIMURA, J., AND KANAIDE, H.: Mechanism of endothelium-dependent relaxation induced by substance P in the coronary artery of the pig. *Br. J. Pharmacol.* **116**: 2040–2047, 1995.
- KWAN, C. Y., CHAUDHARY, R., ZHENG, X. F., NI, J., AND LEE, R. M.: Effects of sarcoplasmic reticulum calcium pump inhibitors on vascular smooth muscle. *Hypertension* **23**: 1156–1160, 1994.
- KWON, S. C., OZAKI, H., HORI, M., AND KARAKI, H.: Isoproterenol changes the relationship between cytosolic Ca^{2+} and contraction in guinea-pig taenia caecum. *Jpn. J. Pharmacol.* **61**: 57–64, 1993.
- LANGLANDS, J. M., AND DIAMOND, J.: The effect of phenylephrine on inositol 1,4,5-trisphosphate levels in vascular smooth muscle measured using a

- protein binding assay system. *Biochem. Biophys. Res. Commun.* **173**: 1258–1265, 1990.
- LASZLO, D., EKSTEIN, D. M., LEWIN, R., AND STERN, K. G.: Biological studies on stable and radioactive rare earth compounds. I. On the distribution of lanthanum in the mammalian organism. *J. Natl. Cancer Inst.* **13**: 559–571, 1952.
- LECHLEITER, J. D., AND CLAPHAM, D. E.: Molecular mechanisms of intracellular calcium excitability in *X. laevis* oocytes. *Cell* **69**: 283–294, 1992.
- LEE, M. Y., BANG, H. W., LIM, I. J., UHM, D. Y., AND RHEE, S. D.: Modulation of large conductance calcium-activated K^+ channel by membrane-delimited protein kinase and phosphatase activities. *Pfluegers Arch.* **429**: 150–152, 1994.
- LEE, S. H., AND EARM, Y. E.: Caffeine induces periodic oscillations of Ca^{2+} -activated K^+ current in pulmonary arterial smooth muscle cells. *Pfluegers Arch.* **426**: 189–198, 1994.
- LEJTEN, P. A. A., AND VAN BREEMEN, C.: The effects of caffeine on the noradrenaline-sensitive calcium store in rabbit aorta. *J. Physiol. (Lond.)* **357**: 327–339, 1984.
- LEPRETRE, N., AND MIRONNEAU, J.: α_2 -Adrenoceptors activate dihydropyridine-sensitive calcium channels via G_i -proteins and protein kinase C in rat portal vein myocytes. *Pfluegers Arch.* **429**: 253–261, 1994.
- LEPRETRE, N., MIRONNEAU, J., ARNAUDEAU, S., TANFIN, Z., HARBON, S., GUILLOU, G., AND IBARRONDO, J.: Activation of α_{1A} adrenoceptors mobilizes calcium from the intracellular stores in myocytes from rat portal vein. *J. Pharmacol. Exp. Ther.* **268**: 167–174, 1994.
- LESH, R. E., MARKS, A. R., SOMLYO, A. V., FLEISCHER, S., AND SOMLYO, A. P.: Anti-ryanodine receptor antibody binding sites in vascular and endocardial endothelium. *Circ. Res.* **72**: 481–488, 1992.
- LETTVIN, J. Y., PICKARD, W. F., MCCULLOCH, W. S., AND PITTS, W.: A theory of passive ion flux through axon membrane. *Nature (Lond.)* **202**: 1338–1339, 1964.
- LEURS, R., BAST, A., AND TIMMERMAN, H.: Fluoride is a contractile agent of guinea pig airway smooth muscle. *Gen. Pharmacol.* **22**: 631–636, 1991.
- LEVIN, R. M., LEVIN, S. S., ZDERIC, S. A., SAITO, M., YOON, J. Y., AND WEIN, A. J.: Effect of partial outlet obstruction of the rabbit urinary bladder on ryanodine binding to microsomal membranes. *Gen. Pharmacol.* **25**: 421–425, 1994.
- LEVITZKI, A., AND GAZIT, A.: Tyrosine kinase inhibition: an approach to drug development. *Science* **267**: 1782–1789, 1995.
- LEVY, J. V.: Contractile responses to prostacyclin (PGI_2) of isolated human saphenous and rat venous tissue. *Prostaglandins* **16**: 93–97, 1978.
- LI, L., AND VAN BREEMEN, C.: Na^+ - Ca^{2+} exchange in intact endothelium of rabbit cardiac valve. *Circ. Res.* **76**: 396–404, 1995.
- LI, L., AND VAN BREEMEN, C.: Agonist- and CPA-induced elevation of cytoplasmic free Ca^{2+} in intact valvular endothelium of rabbits. *Am. J. Physiol.* **270**: H837–H848, 1996.
- LINCOLN, T. M., CORNWELL, T. L., KOMALAVILAS, P., MACMILLAN-CROW, L. A., AND BOERTH, N.: The nitric oxide-cyclic GMP signaling system. In *Biochemistry of Smooth Muscle Contraction*, ed. by M. Barany, pp. 257–268, Academic Press, New York, 1996.
- LINCOLN, T. M., CORNWELL, T. L., AND TAYLOR, A.: E.: cGMP-dependent protein kinase mediates the reduction of Ca^{2+} by cAMP in vascular smooth muscle cells. *Am. J. Physiol.* **258**: C399–C407, 1990.
- LINCOLN, T. M., KOMALAVILAS, P., AND CORNWELL, T. L.: Pleiotropic regulation of vascular smooth muscle tone by cyclic GMP-dependent protein kinase. *Hypertension* **23**: 1141–1147, 1994.
- LIU, L. W., THUNEBERG, L., AND HUIZINGA, J. D.: Cyclopiazonic acid, inhibiting the endoplasmic reticulum calcium pump, reduces the canine colonic pacemaker frequency. *J. Pharmacol. Exp. Ther.* **275**: 1058–1068, 1995.
- LOIRAND, G., AND PACAUD, P.: Mechanism of the ATP-induced rise in cytosolic Ca^{2+} in freshly isolated smooth muscle cells from human saphenous vein. *Pfluegers Arch.* **430**: 429–436, 1995.
- LOW, A. M., KWAN, C. Y., AND DANIEL, E. E.: Evidence for two types of internal Ca^{2+} stores in canine mesenteric artery with different refilling mechanisms. *Am. J. Physiol.* **262**: H31–H37, 1992.
- LUBY-PHELPS, K., HORI, M., PHELPS, J. M., AND WON, D.: Ca^{2+} -regulated dynamic compartmentalization of calmodulin in living smooth muscle cells. *J. Biol. Chem.* **270**: 21532–21538, 1995.
- LUCKHOFF, A., POHL, U., MULSCH, A., AND BUSSE, R.: Differential role of extra- and intracellular calcium in the release of EDRF and prostacyclin from cultured endothelial cells. *Br. J. Pharmacol.* **95**: 189–196, 1988.
- LULLMAN, H.: Calcium fluxes and calcium distribution in smooth muscle. In *Smooth Muscle*, ed. by E. Bulbring, A. F. Brading, A. W. Jones, and T. Tomita, pp. 151–196, Edward Arnold Ltd., London, 1970.
- LUO, D. L., NAKAZAWA, M., ISHIBASHI, T., KATO, K., AND IMAI, S.: Putative, selective inhibitors of sarcoplasmic reticulum calcium pump ATPase inhibit relaxation by nitroglycerin and atrial natriuretic factor of the rabbit aorta contracted by phenylephrine. *J. Pharmacol. Exp. Ther.* **265**: 1187–1192, 1993.
- LUSCHER, T. F., WENZEL, R. R., MOREAU, P., AND TAKASE, H.: Vascular protective effects of ACE inhibitors and calcium antagonists: theoretical basis for a combination therapy in hypertension and other cardiovascular diseases. *Cardiovasc. Drugs Ther.* **9**(suppl. 3): 509–523, 1995.
- LYTTON, J., WESTLIN, M., BURK, S. E., SHULL, G. E., AND MACLENNAN, D. H.: Functional comparisons between isoforms of the sarcoplasmic or endoplasmic reticulum family of calcium pumps. *J. Biol. Chem.* **267**: 14483–14489, 1992.
- LYTTON, J., ZARAIN-HERZBERG, A., PERIASAMY, M., AND MACLENNAN, D. H.: Molecular cloning of the mammalian smooth muscle sarco(endo)plasmic reticulum calcium-ATPase. *J. Biol. Chem.* **264**: 7059–7065, 1989.
- MACKINTOSH, C., BEATTIE, K. A., KLUMPP, S., COHEN, P., AND CODD, G. A.: Cyanobacterial microcystin-LR is a potent and specific inhibitor of protein phosphatases 1 and 2A from both mammals and higher plants. *FEBS Lett.* **264**: 187–192, 1990.
- MACKINTOSH, C., AND KLUMPP, S.: Tautomycin from the bacterium *Streptomyces verticillatus*: another potent and specific inhibitor of protein phosphatase 1 and 2A. *FEBS Lett.* **277**: 137–140, 1990.
- MAEDA, H., YAMAGATA, A., NISHIKAWA, S., YOSHINAGA, K., KOBAYASHI, S., NISHI, K., AND NISHIKAWA, S. I.: Requirement of *c-kit* for development of intestinal pacemaker system. *Development* **116**: 369–375, 1992.
- MAGGI, C. A., GIULIANI, S., AND SANTICIOLI, P.: Effect of the Ca^{2+} -ATPase inhibitor, cyclopiazonic acid, on electromechanical coupling in the guinea-pig ureter. *Br. J. Pharmacol.* **114**: 127–137, 1995.
- MAKIJINA, S. R., ABEBE, W., ALI, S., AND MUSTAFA, S. J.: Simultaneous measurement of intracellular calcium and tension in vascular smooth muscle: validation of the everted ring preparation. *J. Pharmacol. Toxicol. Methods* **34**: 157–163, 1995.
- MALGAROLI, A., MILANI, D., MELDOLESI, J., AND POZZAN, T.: Fura-2 measurement of cytosolic free Ca^{2+} in monolayers and suspensions of various types of animal cells. *J. Cell Biol.* **105**: 2145–2155, 1987.
- MANGELS, L. A., AND GNEGY, M. E.: Carbachol stimulates binding of photoreactive calmodulin derivative to calmodulin-binding proteins in intact SK-N-SH human neuroblastoma cells. *J. Biol. Chem.* **267**: 5847–5854, 1992.
- MANOLOPOULOS, V. G., PIPILI-SYNETOS, E., DEN HERTOOG, A., AND NELEMANS, A.: Inositol phosphate formed in rat aorta after α_1 -adrenoceptor stimulation are inhibited by forskolin. *Eur. J. Pharmacol.* **207**: 29–36, 1991.
- MARKS, T. N., DUBYAK, G. R., AND JONES, S. W.: Calcium currents in the A7r5 smooth muscle-derived cell line. *Pfluegers Arch.* **417**: 433–439, 1990.
- MARMY, N., AND DURAND, J.: Control of inositol phosphate turnover in human airways during histamine stimulation. *Respir. Physiol.* **99**: 291–301, 1995.
- MARMY, N., MOTTAS, J., AND DURAND, J.: Signal transduction in smooth muscle cells from human airways. *Respir. Physiol.* **91**: 295–306, 1993.
- MARSDEN, P. A., DANTHULURI, N. R., BRENNER, B. M., BALLERMANN, B. J., AND BROCK, T. A.: Endothelin action on vascular smooth muscle involves inositol triphosphate and calcium mobilization. *Biochem. Biophys. Res. Commun.* **158**: 886–893, 1989.
- MARTIN, C., DACQUET, C., MIRONNEAU, C., AND MIRONNEAU, J.: Caffeine-induced inhibition of calcium channel current in cultured smooth muscle cells from pregnant rat myometrium. *Br. J. Pharmacol.* **98**: 493–498, 1989.
- MASAKI, T.: Possible role of endothelin in endothelial regulation of vascular tone. *Ann. Rev. Pharmacol. Toxicol.* **35**: 235–255, 1995.
- MASUO, M., REARDON, S., IKEBE, M., AND KITAZAWA, T.: A novel mechanism for the Ca^{2+} -sensitizing effect of protein kinase C on vascular smooth muscle: inhibition of myosin light chain phosphatase. *J. Gen. Physiol.* **104**: 265–286, 1994.
- MATLIB, M. A., WHITMER, K. R., MACCARTHY, E. P., AND OOI, B. S.: Sodium-calcium exchange exists across the cell membrane of intact vascular smooth muscle cells. *J. Hypertens.* **4**(suppl.): S222–S223, 1986.
- MATSUI, T., AMANO, M., YAMAMOTO, T., CHIHARA, K., NAKAHUKU, M., ITO, M., NAKANO, T., OKAWA, K., IWAMATSU, A., AND KAIBUCHI, K.: Rho-associated kinase, a novel serine/threonine kinase, as a putative target for the small GTP binding protein Rho. *EMBO J.* **15**: 2208–2216, 1996.
- MATSUMOTO, T., KANAIDE, H., NISHIMURA, J., KUGA, T., KOBAYASHI, S., AND NAKAMURA, M.: Histamine-induced calcium transients in vascular smooth muscle cells: effects of verapamil and diltiazem. *Am. J. Physiol.* **257**: H563–H570, 1989.
- MATSUMOTO, T., KANAIDE, H., NISHIMURA, J., SHOGAKIUCHI, Y., KOBAYASHI, S., AND NAKAMURA, M.: Histamine activates H_1 -receptors to induce cytosolic free calcium transients in cultured vascular smooth muscle cells from rat aorta. *Biochem. Biophys. Res. Commun.* **135**: 172–177, 1986.
- MATSUMOTO, T., KANAIDE, H., SHOGAKIUCHI, Y., AND NAKAMURA, M.: Characteristics of the histamine-sensitive calcium store in vascular smooth muscle: comparison with norepinephrine- or caffeine-sensitive stores. *J. Biol. Chem.* **265**: 5610–5616, 1990.
- MATTHIJS, G., HIMPENS, B., PEETERS, T. L., AND VANTRAPPEN, G.: Effects of substance P on $[Ca^{2+}]_i$ and force in intact guinea pig ileal smooth muscle. *Am. J. Physiol.* **259**: C150–C160, 1990.
- MCDANIEL, N. L., CHEN, X. L., SINGER, H. A., MURPHY, R. A., AND REMBOLD, C. M.: Nitrovasodilators relax arterial smooth muscle by decreasing $[Ca^{2+}]_i$ and uncoupling stress from myosin phosphorylation. *Am. J. Physiol.* **263**: C461–C467, 1992.
- MCDANIEL, N. L., REMBOLD, C. M., AND MURPHY, R. L.: Cyclic nucleotide dependent relaxation in vascular smooth muscle. *Can. J. Physiol. Pharmacol.* **72**: 1380–1385, 1994.
- MCDANIEL, N. L., REMBOLD, C. M., RICHARD, H. M., AND MURPHY, R. A.: Cyclic AMP relaxes swine arterial smooth muscle predominantly by decreasing cell Ca^{2+} concentration. *J. Physiol. (Lond.)* **439**: 147–160, 1991.
- MCDONALD, T. F., PELZER, S., TRAUTWEIN, W., AND PELZER, D.: Regulation and modulation of calcium channels in cardiac, skeletal and smooth muscle cells. *Physiol. Rev.* **74**: 365–507, 1994.

- MCGROGAN, I., LU, S., HIPWORTH, S., SORMAZ, L., ENG, R., PREOCANIN, D., AND DANIEL, E. E.: Mechanisms of cyclic nucleotide-induced relaxation in canine tracheal smooth muscle. *Am. J. Physiol.* **268**: L407-L423, 1995.
- MEISHERI, K. D., HWANG, O., AND VAN BREEMEN, C.: Evidence for two separated Ca^{2+} pathways in smooth muscle plasmalemma. *J. Membr. Biol.* **59**: 19-25, 1981.
- MENE, P., ABBOD, H. E., DUBYAK, G. R., SCARPA, A., AND DUNN, M. J.: Effects of PDGF on inositol phosphates, Ca^{2+} and contraction of mesangial cells. *Am. J. Physiol.* **253**: F458-F463, 1987.
- MENE, P., PUGLIESE, F., FARAGGIANA, T., AND CINOTTI, G. A.: Identification and characteristics of a $\text{Na}^+/\text{Ca}^{2+}$ exchanger in cultured human mesangial cells. *Kidney Int.* **38**: 1199-1205, 1990.
- MERRITT, J. E., ARMSTRONG, W. P., BENHAM, C. D., HALLAM, T. J., JACOB, R., JAXA-CHAMIEC, A., LEIGH, B. K., MCCARTHY, S. A., MOORES, K. E., AND RINK, T. J.: SKF 96365, a novel inhibitor of receptor-mediated calcium entry. *Biochem. J.* **271**: 515-522, 1990.
- MIKI, N., KAWABE, Y., AND KURIYAMA, K.: Activation of cerebral guanylate cyclase by nitric oxide. *Biochem. Biophys. Res. Commun.* **75**: 851-856, 1977.
- MIKOSHIBA, K.: Inositol 1,4,5-trisphosphate receptor. *Trends Pharmacol. Sci.* **14**: 86-89, 1993.
- MILLER, J. R., SILVER, P. J., AND STULL, J. T.: The role of myosin light chain kinase phosphorylation in β -adrenergic relaxation of tracheal smooth muscle. *Mol. Pharmacol.* **24**: 235-242, 1983.
- MINO, T., YUASA, U., NAKA, M., AND TANAKA, T.: Phosphorylation of calponin mediated by protein kinase C in association with contraction in porcine coronary artery. *Biochem. Biophys. Res. Commun.* **208**: 397-404, 1995.
- MISSIAEN, L., DECLERCK, I., DROOGMANS, G., PLESSERS, L., DE SMEDT, H., RAEYMAEKERS, L., AND CASTEELS, R.: Agonist-dependent Ca^{2+} and Mn^{2+} entry dependent on state of filling of Ca^{2+} stores in aortic smooth muscle cells of the rat. *J. Physiol. (Lond.)* **427**: 171-186, 1990.
- MISSIAEN, L., DE SMEDT, H., DROOGMANS, G. G., AND CASTEELS, R.: 2,5-Di-(*tert*-butyl)-1,4-benzohydroquinone and cyclopiazonic acid decrease the calcium permeability of endoplasmic reticulum. *Eur. J. Pharmacol. Mol. Pharmacol. Sec.* **9**: 391-394, 1992.
- MISSIAEN, L., OIKE, M., BOOTMAN, M. D., DE SMEDT, H., PARYS, J. B., AND CASTEELS, R.: Vasopressin responses in electrically coupled A7r5 cells. *Pfluegers Arch.* **428**: 283-287, 1994a.
- MISSIAEN, L., PARYS, J. B., DE SMEDT, H., HIMPENS, B., AND CASTEELS, R.: Inhibition of inositol trisphosphate-induced calcium release by caffeine is prevented by ATP. *Biochem. J.* **300**: 81-84, 1994b.
- MITSUHASHI, M., AND PAYAN, D. G.: Phorbol ester-mediated desensitization of histamine H_1 receptors on a cultured smooth muscle cell line. *Life Sci.* **43**: 1433-1440, 1988.
- MITSUI, M., ABE, A., TAJIMI, M., AND KARAKI, H.: Leakage of a fluorescent Ca^{2+} indicator, fura-2, in smooth muscle. *Jpn. J. Pharmacol.* **61**: 165-170, 1993.
- MITSUI, M., AND KARAKI, H.: Dual effects of carbachol on cytosolic Ca^{2+} and contraction in intestinal smooth muscle. *Am. J. Physiol.* **258**: C787-C793, 1990.
- MITSUI, M., AND KARAKI, H.: Contractile and relaxant effects of phorbol ester in the intestinal smooth muscle of guinea-pig *taenia caeci*. *Br. J. Pharmacol.* **109**: 229-233, 1993.
- MITSUI, M., NAKAO, K., INUKAI, T., AND KARAKI, H.: Inhibitory effects of cadralazine and its metabolite, ISF-2405, on contractions and the level of cytosolic Ca^{2+} in vascular smooth muscle. *Eur. J. Pharmacol.* **178**: 171-177, 1990.
- MITSUI-SAITO, M., AND KARAKI, H.: Carbachol but not acetylcholine inhibits contraction by the protein kinase C-dependent and -independent pathways in the smooth muscle of guinea pig *taenia caeci*. *Jpn. J. Pharmacol.* **72**: 23-28, 1996.
- MIYAZAKI, S., YAZAKI, M., NAKADA, K., SHIRAKAWA, H., NAKANISHI, S., NAKADE, S., AND MIKOSHIBA, K.: Block of Ca^{2+} wave and Ca^{2+} oscillation by antibody to the inositol 1,4,5-trisphosphate receptor in fertilized hamster eggs. *Science (Wash. DC)* **257**: 251-255, 1992.
- MIYOSHI, Y., AND NAKAYA, Y.: Angiotensin II blocks ATP-sensitive K^+ channels in porcine coronary artery smooth muscle cells. *Biochem. Biophys. Res. Commun.* **181**: 700-706, 1991.
- MOGAMI, H., AND KOJIMA, I.: Stimulation of calcium entry is prerequisite for DNA synthesis induced by platelet-derived growth factor in vascular smooth muscle cells. *Biochem. Biophys. Res. Commun.* **196**: 650-658, 1993.
- MONCADA, S., PALMER, R. M. J., AND HIGGS, E. A.: Nitric oxide: physiology, pathophysiology, and pharmacology. *Pharmacol. Rev.* **43**: 109-142, 1991.
- MOORE, E. D., ETTER, E. F., PHILIPSON, K. D., CARRINGTON, W. A., FOGARTY, K. E., LIFSHITZ, L. M., AND FAY, F. S.: Coupling of the $\text{Na}^+/\text{Ca}^{2+}$ exchanger, Na^+/K^+ pump and sarcoplasmic reticulum in smooth muscle. *Nature (Lond.)* **365**: 657-660, 1993.
- MOREL, N., AND GODFRAIND, T.: Sodium/calcium exchange in smooth muscle microsomal fractions. *Biochem. J.* **218**: 421-427, 1984.
- MORGAN, J. P., AND MORGAN, K. G.: Vascular smooth muscle: the first recorded Ca^{2+} transients. *Pfluegers Arch.* **395**: 75-77, 1982.
- MORGAN, J. P., AND MORGAN, K. G.: Alteration of cytoplasmic ionized calcium levels in smooth muscle by vasodilators in the ferret. *J. Physiol. (Lond.)* **357**: 539-551, 1984a.
- MORGAN, J. P., AND MORGAN, K. G.: Stimulus-specific patterns of intracellular calcium levels in smooth muscle of ferret portal vein. *J. Physiol. (Lond.)* **351**: 155-167, 1984b.
- MORGAN, K. G., DE FEO, T. T., WENC, K., AND WEINSTEIN, R.: Alterations of excitation-contraction coupling by platelet-derived growth factor in enzymatically isolated and cultured vascular smooth muscle cells. *Pfluegers Arch.* **405**: 77-79, 1985.
- MORI, T., YANAGISAWA, T., AND TAIRA, N.: Histamine increases vascular tone and intracellular calcium level using both intracellular and extracellular calcium in porcine coronary artery. *Jpn. J. Pharmacol.* **52**: 263-271, 1990a.
- MORI, T., YANAGISAWA, T., AND TAIRA, N.: Phorbol 12, 13-dibutyrate increases vascular tone but has a dual action on intracellular calcium levels in porcine coronary artery. *Naunyn-Schmiedeberg's Arch. Pharmacol.* **341**: 251-255, 1990b.
- MORIMOTO, S., KOH, E., FUKUO, K., IMANAKA, S., HIRONAKA, T., SHIRAI, T., YAMAMOTO, H., ITOH, K., ONISHI, T., AND KUMAHARA, Y.: Effect of nicorandil on the cytosolic free calcium concentration and microsomal (Ca^{2+} + Mg^{2+})-ATPase activity of vascular smooth muscle cells. *J. Cardiovasc. Pharmacol.* **10** (suppl. 8): S31-S37, 1987.
- MORITOKI, H., HISAYAMA, T., TAKEUCHI, S., KONDOH, W., AND IMAGAWA, M.: Relaxation of rat aorta induced by the Ca^{2+} -ATPase inhibitor, cyclopiazonic acid, possibly through nitric oxide formation. *Br. J. Pharmacol.* **111**: 655-662, 1994.
- MULVANY, M. J., AALKJAER, C., AND PETERSEN, T. T.: Intracellular sodium, membrane potential and contractility of rat mesenteric small arteries. *Circ. Res.* **54**: 740-749, 1984.
- MUNRO, D. D., AND WENDT, I. R.: Effects of cyclopiazonic acid on $[\text{Ca}^{2+}]_i$ and contraction in rat urinary bladder smooth muscle. *Cell Calcium* **15**: 369-380, 1994.
- MURAKAMI, K., SHINDO, K., ITO, K. M., AND ITO, K.: Effects of semotiadil fumarate (SD-3211) and its enantiomer, SD-3212, on the changes in cytosolic Ca^{2+} and tension caused by KCl and norepinephrine in isolated rat aortas. *J. Cardiovasc. Pharmacol.* **25**: 262-267, 1995.
- MURAKI, K., BOLTON, T. B., IMAIZUMI, Y., AND WATANABE, M.: Effect of isoprenaline on Ca^{2+} channel current in single smooth muscle cells isolated from taenia of the guinea-pig caecum. *J. Physiol.* **471**: 563-582, 1993.
- MURPHY, R. A.: What is special about smooth muscle? The significance of covalent crossbridge regulation. *FASEB J.* **8**: 311-318, 1994.
- NABEL, E. G., BERK, B. C., BROCK, T. A., AND SMITH, T. W.: Na^+ - Ca^{2+} exchange in cultured vascular smooth muscle cells. *Circ. Res.* **62**: 486-493, 1988.
- NABIKI, T., VELLETRI, P. A., LOVENBERG, W., AND BEAVEN, M. A.: Increase in cytosolic calcium and phosphoinositide metabolism induced by angiotensin II and [Arg]vasopressin in vascular smooth muscle cells. *J. Biol. Chem.* **260**: 4661-4670, 1985.
- NAGANOBU, K., AND ITO, K.: Handling of cytoplasmic Ca^{2+} by the sarcoplasmic reticulum during α 1-adrenoceptor-mediated contraction of rat mesenteric resistance arteries. *Jpn. J. Pharmacol.* **64**: 89-96, 1994.
- NAGANOBU, K., TAKAGI, M., KAWASAKI, H., AND ITO, K.: Modification by cyclopiazonic acid and ryanodine of depolarization-induced constriction in rat mesenteric artery. *Eur. J. Pharmacol.* **251**: 307-310, 1994.
- NAGASAKI, M., KOBAYASHI, T., AND TAMAKI, H.: Effects of trimebutine on cytosolic Ca^{2+} and force transitions in intestinal smooth muscle. *Eur. J. Pharmacol.* **195**: 317-321, 1991.
- NAGESSETTY, R., AND PAUL, R. J.: Effects of pH_i on isometric force and $[\text{Ca}^{2+}]_i$ in porcine coronary artery smooth muscle. *Circ. Res.* **75**: 990-998, 1994.
- NAKAGAWA, H., KARAKI, H., AND URAKAWA, N.: Effects of antimycin A on vascular and intestinal smooth muscle contraction. *Arch. Int. Pharmacodyn. Ther.* **276**: 92-105, 1985.
- NAKAJIMA, S., FUJIMOTO, M., AND UEDA, M.: Spatial changes of $[\text{Ca}^{2+}]_i$ and contraction caused by phorbol esters in vascular smooth muscle cells. *Am. J. Physiol.* **265**: C1138-C1145, 1993.
- NAKAJIMA, S., KUROKAWA, K., IMAMURA, N., AND UEDA, M.: A study on the hypotensive mechanism of pinacidil: relationship between its vasodilating effect and intracellular Ca^{2+} levels. *Jpn. J. Pharmacol.* **49**: 205-213, 1989.
- NAKAMURA, F., MINO, T., YAMAMOTO, J., NAKA, M., AND TANAKA, T.: Identification of the regulatory site in smooth muscle calponin that is phosphorylated by protein kinase C. *J. Biol. Chem.* **268**: 6194-6201, 1993.
- NAKANISHI, S., KAKITA, S., TAKAHASHI, I., KAWAHARA, K., TSUKUDA, E., SANO, T., YAMADA, K., YOSHIDA, M., KASE, H., MATSUDA, Y., HASHIMOTO, Y., AND NONOMURA, Y.: Wortmannin, a microbial product inhibitor of myosin light chain kinase. *J. Biol. Chem.* **267**: 2157-2163, 1992.
- NAKAYAMA, S., SMITH, L. M., TOMITA, T., AND BRADING, A. F.: Multiple open states of calcium channels and their possible kinetic schemes. *In* *Smooth Muscle Excitation*, ed. by T. Bolton and T. Tomita, pp. 13-25, Academic Press, London, 1996.
- NAKAYAMA, K., AND TANAKA, Y.: Myogenic contraction and relaxation of arterial smooth muscle. *In* *Essential Hypertension*, ed. by K. Aoki, pp. 83-93, Springer-Verlag, Tokyo, 1989.
- NAKAYAMA, K., AND TANAKA, Y.: Stretch-induced contraction and Ca^{2+} mobilization in vascular smooth muscle. *Biol. Signals* **2**: 241-252, 1993.
- NAKAZAWA, M., AND IMAI, S.: Rp-8-Br-guanosine-3', 5'-cyclic monophosphothioate inhibits relaxation elicited by nitroglycerin in rabbit aorta. *Eur. J. Pharmacol.* **253**: 179-181, 1994.
- NAMBA, H., AND TSUCHIDA, H.: Effect of volatile anesthetics with and without verapamil on intracellular activity in vascular smooth muscle. *Anesthesiology* **84**: 1465-1474, 1996.
- NARUSE, K., AND SOKABE, M.: Involvement of stretch-activated ion channels in

- Ca²⁺ mobilization to mechanical stretch in endothelial cells. *Am. J. Physiol.* **264**: C1037–C1044, 1993.
- NASU, T., ISHIDA, Y., AND URAKAWA, N.: Inhibitory effects of caffeine on developed tension and calcium movement in guinea-pig *taenia coli* in high K medium. *Jpn. J. Pharmacol.* **25**: 207–214, 1975.
- NEBIGIL, C., AND MALIK, K. U.: α -Adrenergic receptor subtypes involved in prostaglandin synthesis are coupled to Ca⁺⁺ channels through a pertussis toxin-sensitive guanine nucleotide-binding protein. *J. Pharmacol. Exp. Ther.* **266**: 1113–1124, 1993.
- NELSON, M. T., CHENG, H., RUBART, M., SANTANA, L. F., BONEV, A. D., KNOT, H. J., AND LEDERER, W. J.: Relaxation of arterial smooth muscle by calcium sparks. *Science (Wash. DC)* **270**: 633–637, 1995.
- NELSON, M. T., HUANG, Y., BRAYDEN, J. E., HESCHELER, J., AND STANDEN, N. B.: Arterial dilations in response to calcitonin gene-related peptide involve activation of K⁺ channels. *Nature (Lond.)* **344**: 770–773, 1990.
- NELSON, M. T., STANDEN, N. B., BRAYDEN, J. E., AND WORLEY, J. F.: Noradrenaline contracts arteries by activating voltage-dependent calcium channels. *Nature (Lond.)* **336**: 382–385, 1988.
- NEUSSER, M., TEPEL, M., GOLINSKI, P., HOLTHUES, J., SPIEKER, C., ZHU, Z., AND ZIDEK, W.: Different calcium storage pools in vascular smooth muscle cells from spontaneously hypertensive and normotensive Wistar-Kyoto rats. *J. Hypertens.* **12**: 533–538, 1994.
- NEVEU, D., QUIGNARD, J. F., FERNANDEZ, A., RICHARD, S., AND NARGEOT, J.: Differential β -adrenergic regulation and phenotypic modulation of voltage-gated calcium currents in rat aortic myocytes. *J. Physiol. (Lond.)* **479**: 171–182, 1994.
- NEYLON, C. B., HOYLAND, J., MASON, W. T., AND IRVINE, R. F.: Spatial dynamics of intracellular calcium in agonist-stimulated vascular smooth muscle cells. *Am. J. Physiol.* **259**: C675–C686, 1990.
- NICOLL, D. A., AND PHILIPSON, K. D.: Molecular studies of the cardiac sarcolemmal sodium-calcium exchanger. *Ann. N. Y. Acad. Sci.* **639**: 181–188, 1991.
- NILIUS, B., DROOGMANS, G., GERICKE, M., AND SCHWARZ, G.: Nonselective ion pathways in human endothelial cells. In *Nonselective Cation Channels: Pharmacology, Physiology and Biophysics*, ed. by D. Siemen, and J. Hescheler, pp. 269–280. Birkhauser Verlag, Basel, 1993.
- NILSSON, B. O., AND HELLSTRAND, P.: Effects of polyamines on intracellular calcium and mechanical activity in smooth muscle of guinea-pig *taenia coli*. *Acta Physiol. Scand.* **148**: 37–43, 1993.
- NISHI, K., TOKUTOMI, N., SATO, D., TOKUTOMI, Y., SUGITA, M., LAI, Z. F., AND TORIHASHI, S.: Identification of gastrointestinal tract pacemaker cells and their functional significance. In *Gastrointestinal Function: Regulation and Disturbance*, vol. 14, pp. 27–43, Excerpta Medica, Ltd., Tokyo, 1996.
- NISHIKAWA, M., DE LANEROLLE, P., LINCOLN, T. M., AND ADELSTEIN, R. S.: Phosphorylation of mammalian myosin light chain kinases by the catalytic subunit of cyclic AMP dependent protein kinase and by cyclic GMP-dependent protein kinase. *J. Biol. Chem.* **259**: 8429–8436, 1984.
- NISHIMURA, J., AND VAN BREEMEN, C.: Direct regulation of smooth muscle contractile elements by second messenger. *Biochem. Biophys. Res. Commun.* **163**: 929–935, 1989.
- NISHIMURA, J., KHALIL, R. A., DRENTH, J. P., AND VAN BREEMEN, C.: Evidence for increased myofilament Ca²⁺ sensitivity in norepinephrine-activated vascular smooth muscle. *Am. J. Physiol.* **259**: H2–H8, 1990.
- NISHIMURA, J., KOLBER, M., AND VAN BREEMEN, C.: Norepinephrine and GTP γ S increase myofilament Ca²⁺ sensitivity in α -toxin permeabilized arterial smooth muscle. *Biochem. Biophys. Res. Commun.* **157**: 677–683, 1988.
- NISHIMURA, J., MORELAND, S., AHN, H. Y., KAWASE, T., MORELAND, R. S., AND VAN BREEMEN, C.: Endothelin increases myofilament Ca²⁺ sensitivity in α -toxin permeabilized rabbit mesenteric artery. *Circ. Res.* **71**: 951–959, 1992.
- NISHIMURA, J., SAKIHARA, C., ZHOU, Y., AND KANAIDE, H.: Expression of Rho A and Rho kinase in porcine vascular smooth muscle. *Biochem. Biophys. Res. Commun.* **227**: 750–754, 1996.
- NISHIO, A., ISHIGURO, S., SHIMONISHI, I., AND HIROTA, A.: Enhanced contractile response to noradrenaline and calcium influx in thoracic aorta isolated from dietary magnesium deficient rats. *Magn. Res.* **2**: 173–178, 1989.
- NISHIZUKA, Y.: Protein kinase C and lipid signaling for sustained cellular responses. *FASEB J.* **9**: 484–496, 1995.
- NIXON, G. F., IZUKA, K., HAYSTEAD, C. M. M., HYTEAD, T. A. J., SOMLYO, A. P., AND SOMLYO, A. V.: Phosphorylation of caldesmon by mitogen-activated protein kinase with no effect on Ca²⁺ sensitivity in rabbit smooth muscle. *J. Physiol. (Lond.)* **487**: 283–289, 1995.
- NODA, M., YASUDA-FUKAZAWA, C., MORIISHI, K., KATO, T., OKUDA, T., KUROKAWA, K., AND TAKUWA, Y.: Involvement of Rho in GTP γ S-induced enhancement of phosphorylation of 20 kDa myosin light chain in vascular smooth muscle cells: inhibition of phosphatase activity. *FEBS Lett.* **367**: 246–250, 1995.
- NUKI, C., KAWASAKI, H., KITAMURA, K., TAKENAGA, M., KANGAWA, K., ETO, T., AND WADA, A.: Vasodilator effect of adrenomedullin and calcitonin gene-related peptide receptors in rat mesenteric vascular beds. *Biochem. Biophys. Res. Commun.* **196**: 245–251, 1993.
- OBARA, K., TAKAI, A., RUEGG, J. C., AND DE LANEROLLE, P.: Okadaic acid, a phosphatase inhibitor, produces a Ca²⁺ and calmodulin-independent contraction of smooth muscle. *Pfluegers Arch.* **414**: 134–138, 1989.
- OBARA, K., AND YABU, H.: Dual effect of phosphatase inhibitors on calcium channels in intestinal smooth muscle cells. *Am. J. Physiol.* **264**: C296–C301, 1993.
- OBARA, K., AND YABU, H.: Effect of cytochalasin B on intestinal smooth muscle cells. *Eur. J. Pharmacol.* **255**: 139–147, 1994.
- OGAWA, Y.: Role of ryanodine receptors. *Crit. Rev. Biochem. Mol. Biol.* **29**: 229–274, 1994.
- OHANIAN, V., OHANIAN, J., SHAW, L., SCARTH, S., PARKER, P. J., AND HEAGERY, A. M.: Identification of protein kinase C isoforms in rat mesenteric small arteries and their possible role in agonist-induced contraction. *Circ. Res.* **78**: 806–812, 1996.
- OHATA, H., KAWANISHI, T., HISAMITSU, T., TAKAHASHI, M., AND MOMOSE, K.: Functional coupling of the Na⁺/Ca²⁺ exchanger with Ca²⁺ release from intracellular stores in cultured smooth muscle cells of guinea pig ileum. *Life Sci.* **58**: 1179–1187, 1996.
- OHATA, H., KAWANISHI, T., KAWANISHI, M., UNEYAMA, C., TAKAHASHI, M., AND MOMOSE, K.: Spontaneous oscillations of cytoplasmic free calcium ion concentration in cultured smooth muscle cells from guinea pig ileum. *Jpn. J. Pharmacol.* **63**: 83–91, 1993.
- OHIZUMI, Y., KAJIWARA, A., AND YASUMOTO, T.: Excitatory effect of the most potent marine toxin, maitotoxin, on the guinea-pig vas deferens. *J. Pharmacol. Exp. Ther.* **227**: 199–204, 1983.
- OHIZUMI, Y., AND YASUMOTO, T.: Contractile response of the rabbit aorta to maitotoxin, the most potent marine toxin. *J. Physiol. (Lond.)* **337**: 711–721, 1983a.
- OHIZUMI, Y., AND YASUMOTO, T.: Contraction and increase in tissue calcium content induced by maitotoxin, the most potent known marine toxin, in intestinal smooth muscle. *Br. J. Pharmacol.* **79**: 3–5, 1983b.
- OHOKA, M., HONDA, M., MORIOKA, S., ISHIKAWA, S., NAKAYAMA, K., YAMORI, Y., AND MORIYAMA, K.: Effects of E-1020, a new cyclic AMP-specific phosphodiesterase inhibitor, on cyclic AMP and cytosolic free calcium of cultured vascular smooth muscle cells. *Jpn. Circ. J.* **54**: 679–687, 1990.
- OHTA, T., ITO, S., AND NAKAZATO, Y.: All-or-nothing responses to carbachol in single intestinal smooth muscle cells of rat. *Br. J. Pharmacol.* **112**: 972–976, 1994.
- OHTA, T., ITO, S., AND NAKAZATO, Y.: Chloride currents activated by caffeine in rat intestinal smooth muscle cells. *J. Physiol. (Lond.)* **465**: 149–162, 1993.
- OHTA, T., ITO, S., NOTO, T., TACHIBANA, R., NAKAZATO, Y., AND OHGA, A.: The inhibitory action of cyclic AMP on responses to carbachol dependent on calcium stores in rat gastric smooth muscle. *J. Physiol. (Lond.)* **453**: 367–384, 1992.
- OHTA, T., ITO, S., AND OHGA, A.: Effects of vasoactive intestinal peptide (VIP) on contractile responses of smooth muscle in rat stomach. *Br. J. Pharmacol.* **102**: 621–626, 1991.
- OHTA, T., KAWAI, K., ITO, S., AND NAKAZATO, Y.: Ca²⁺ entry activated by emptying of intracellular Ca²⁺ stores in ileal smooth muscle of the rat. *Br. J. Pharmacol.* **114**: 1165–1170, 1995.
- OHYA, Y., KITAMURA, K., AND KURIYAMA, H.: Cellular calcium regulates outward currents in rabbit intestinal smooth muscle cell. *Am. J. Physiol.* **252**: C401–C410, 1987.
- OIKE, M., DROOGMANS, G., AND NILIUS, B.: Mechanosensitive Ca²⁺ transients in endothelial cells from human umbilical vein. *Proc. Natl. Acad. Sci. USA* **91**: 2940–2944, 1994.
- OISHI, K., MITA, M., ONO, T., HASHIMOTO, T., AND UCHIDA, M. K.: Protein kinase C-independent sensitization of contractile proteins to Ca²⁺ in α -toxin permeabilized smooth muscle cells from guinea-pigs stomach. *Br. J. Pharmacol.* **107**: 908–909, 1992.
- OKADA, T., SAKUMA, L., FUKUI, Y., HAZEKI, O., AND UI, M.: Blockage of chemotactic peptide-induced stimulation of neutrophils by wortmannin as a result of selective inhibition of phosphatidylinositol 3-kinase. *J. Biol. Chem.* **269**: 3563–3567, 1994.
- OKADA, Y., YANAGISAWA, T., AND TAIRA, N.: BRL 38227 (levromakalim)-induced hyperpolarization reduces the sensitivity to Ca²⁺ of contractile elements in canine coronary artery. *Naunyn Schmiedebergs Arch. Pharmacol.* **347**: 438–444, 1993b.
- OKADA, Y., YANAGISAWA, T., AND TAIRA, N.: KCl-depolarization potentiates the Ca²⁺ sensitization by endothelin-1 in canine coronary artery. *Jpn. J. Pharmacol.* **60**: 403–405, 1992.
- OKADA, Y., YANAGISAWA, T., YAMAGISHI, T., AND TAIRA, N.: K⁺ channel-opening action and KRN 2391-induced reduction of Ca²⁺ sensitivity of arterial smooth muscle. *Arch. Int. Pharmacodyn. Ther.* **326**: 33–51, 1993a.
- ORIMO, H., HAN, S. Z., TABATA, R. E., STERGIPOULOS, K., OUCHI, Y., AND KARAKI, H.: Calcium channel blocking substances for prevention of atherosclerosis. *Ann. N. Y. Acad. Sci.* **748**: 447–460, 1995.
- OSTERMAN, A., ARNER, A., AND MALMQVIST, U.: Effects of 2,3-butanedione monoxime on activation of contraction and crossbridge kinetics in intact and chemically skinned smooth muscle fibres from guinea pig *taenia coli*. *J. Muscle Res. Cell Motil.* **14**: 186–194, 1993.
- OTTO, B., STEUSLOFF, A., JUST, I., AKTORIES, K., AND PFITZER, G.: Role of Rho proteins in carbachol-induced contractions in intact and permeabilized guinea-pig intestinal smooth muscle. *J. Physiol. (Lond.)* **496**: 317–329, 1996.
- OZAKI, H., ABE, A., UEHIGASHI, Y., KINOSHITA, M., HORI, M., MITSUI-SAITO, M., AND KARAKI, H.: Effects of a prostaglandin I₂ analog, iloprost on cytoplasmic Ca²⁺ levels and muscle contraction in isolated guinea pig aorta. *Jpn. J. Pharmacol.* **71**: 231–237, 1996.
- OZAKI, H., AND KARAKI, H.: Effect of marine sponge, okadaic acid, on smooth

- muscle contractility. *In* Mycotoxins and Phycotoxins '88 [A Collection of Invited Papers at the Seventh International IUPAC Symposium on Mycotoxins and Phycotoxins '88], ed. by S. Natori, K. Hashimoto, and Y. Ueno. pp. 445-452, Elsevier Science Publishers B V, Amsterdam, 1989.
- OZAKI, H., AND KARAKI, H.: Different Ca^{2+} -sensitivity in phasic and tonic types of smooth muscles. *Biol. Signals* **2**: 253-262, 1993.
- OZAKI, H., AND URAKAWA, N.: Na-Ca exchange and tension development in guinea-pig aorta. *Naunyn-Schmiedeberg's Arch. Pharmacol.* **309**: 171-178, 1979.
- OZAKI, H., AND URAKAWA, N.: Effects of K-free solution on tension development and Na content in vascular smooth muscles isolated from guinea-pig, rat and rabbit. *Pfluegers Arch.* **389**: 189-193, 1981a.
- OZAKI, H., AND URAKAWA, N.: Involvement of Na-Ca exchange mechanism in contraction induced by low- Na^+ solution in isolated guinea-pig aorta. *Pfluegers Arch.* **390**: 107-112, 1981b.
- OZAKI, H., BLONDFIELD, D. P., HORI, M., PUBLICOVER, N. G., KATO, I., AND SANDERS, K. M.: Spontaneous release of nitric oxide inhibits electrical, Ca^{2+} and mechanical transients in canine gastric smooth muscle. *J. Physiol. (Lond.)* **445**: 231-247, 1992a.
- OZAKI, H., BLONDFIELD, D. P., HORI, M., SANDERS, K. M., AND PUBLICOVER, N. G.: Cyclic AMP-mediated regulation of excitation-contraction coupling in canine gastric smooth muscle. *J. Physiol. (Lond.)* **447**: 351-372, 1992b.
- OZAKI, H., GERTHOFFER, W. T., HORI, M., KARAKI, H., SANDERS, K. M., AND PUBLICOVER, N. G.: Ca^{2+} regulation of the contractile apparatus in canine gastric smooth muscle. *J. Physiol. (Lond.)* **460**: 33-50, 1993.
- OZAKI, H., GERTHOFFER, W. T., PUBLICOVER, N. G., FUSEYANI, N., AND SANDERS, K. M.: Time-dependent changes in Ca^{2+} sensitivity during phasic contraction of canine antral smooth muscle. *J. Physiol. (Lond.)* **440**: 207-224, 1991a.
- OZAKI, H., ISHIHARA, H., KOHAMA, K., NONOMURA, Y., SHIBATA, S., AND KARAKI, H.: Calcium-independent phosphorylation of smooth muscle myosin light chain by okadaic acid isolated from black sponge, *Halichondria okadai*. *J. Pharmacol. Exp. Ther.* **243**: 1167-1173, 1987a.
- OZAKI, H., KARAKI, H., AND URAKAWA, N.: Possible role of Na-Ca exchange mechanism in the contractions induced in guinea-pig aorta by potassium-free solution and ouabain. *Naunyn-Schmiedeberg's Arch. Pharmacol.* **304**: 203-209, 1978.
- OZAKI, H., KASAI, H., HORI, M., SATO, K., ISHIHARA, H., AND KARAKI, H.: Direct inhibition of chicken gizzard smooth muscle contractile apparatus by caffeine. *Naunyn-Schmiedeberg's Arch. Pharmacol.* **341**: 262-267, 1990a.
- OZAKI, H., KOHAMA, K., NONOMURA, Y., SHIBATA, S., AND KARAKI, H.: Direct activation by okadaic acid of the contractile elements in the smooth muscle of guinea-pig *taenia coli*. *Naunyn-Schmiedeberg's Arch. Pharmacol.* **335**: 356-358, 1987b.
- OZAKI, H., KWON, S. C., TAJIMI, M., AND KARAKI, H.: Changes in cytosolic Ca^{2+} and contraction induced by various stimulants and relaxants in canine tracheal smooth muscle. *Pfluegers Arch.* **416**: 351-359, 1990b.
- OZAKI, H., OHYAMA, T., SATO, K., AND KARAKI, H.: Ca^{2+} -dependent and independent mechanisms of sustained contraction in vascular smooth muscle of rat aorta. *Jpn. J. Pharmacol.* **52**: 509-512, 1990c.
- OZAKI, H., SATO, K., SAKATA, K., AND KARAKI, H.: Endothelin dissociates muscle tension from cytosolic Ca^{2+} in vascular smooth muscle of rat carotid artery. *Jpn. J. Pharmacol.* **50**: 521-524, 1989.
- OZAKI, H., SATO, K., SATOH, T., AND KARAKI, H.: Simultaneous recordings of calcium signals and mechanical activity using fluorescent dye fura 2 in isolated strips of vascular smooth muscle. *Jpn. J. Pharmacol.* **45**: 429-433, 1987c.
- OZAKI, H., SATOH, T., KARAKI, H., AND ISHIDA, Y.: Regulation of metabolism and contraction by cytoplasmic calcium in the intestinal smooth muscle. *J. Biol. Chem.* **263**: 14074-14079, 1988.
- OZAKI, H., STEVENS, R. J., BLONDFIELD, D. P., PUBLICOVER, N. G., AND SANDERS, K. M.: Simultaneous measurement of membrane potential, cytosolic Ca^{2+} and muscle tension in intact smooth muscles. *Am. J. Physiol.* **260**: C917-C925, 1991b.
- OZAKI, H., ZHANG, L., BUXTON, I. L. O., SANDERS, K. M., AND PUBLICOVER, N. G.: Negative-feedback regulation of excitation-contraction coupling in gastric smooth muscle. *Am. J. Physiol.* **263**: C1160-C1171, 1992c.
- OZHAN, M., SILL, J. C., ATAGUNDUZ, P., MARTIN, R., AND KATUSIC, Z. S.: Volatile anesthetics and agonist-induced contractions in porcine coronary artery smooth muscle and Ca^{2+} mobilization in cultured immortalized vascular smooth muscle cells. *Anesthesiology* **80**: 1102-1113, 1994.
- PACAUD, P., AND BOLTON, T. B.: Relation between muscarinic receptor cationic current and internal calcium in guinea-pig jejunal smooth muscle cells. *J. Physiol. (Lond.)* **441**: 477-499, 1991.
- PACAUD, P., AND LOIRAND, G.: Release of Ca^{2+} by noradrenaline and ATP from the same Ca^{2+} store sensitive to both InsP_3 and Ca^{2+} in rat portal vein myocytes. *J. Physiol. (Lond.)* **484**: 549-555, 1995.
- PACAUD, P., GREGOIRE, G., AND LOIRAND, G.: Release of Ca^{2+} from intracellular store in smooth muscle cells of rat portal vein by ATP-induced Ca^{2+} entry. *Br. J. Pharmacol.* **113**: 457-462, 1994.
- PACAUD, P., LOIRAND, G., BARON, A., MIRONNEAU, C., AND MIRONNEAU, J.: Ca^{2+} channel activation and membrane depolarization mediated by Cl^- channels in response to noradrenaline in vascular myocytes. *Br. J. Pharmacol.* **104**: 1000-1006, 1991.
- PACAUD, P., LOIRAND, G., BOLTON, T. B., MIRONNEAU, C., AND MIRONNEAU, J.: Intracellular cations modulate noradrenaline-stimulated calcium entry into smooth muscle cells of rat portal vein. *J. Physiol. (Lond.)* **456**: 541-556, 1992.
- PACAUD, P., LOIRAND, G., GREGOIRE, G., MIRONNEAU, C., AND MIRONNEAU, J.: Noradrenaline-activated heparin-sensitive Ca^{2+} entry after depletion of intracellular Ca^{2+} store in portal vein smooth muscle cells. *J. Biol. Chem.* **268**: 3866-3872, 1993.
- PAGLIN, S., TAKUWA, Y., KAMM, K. E., STULL, J. T., GAVRAS, H., AND RASMUSSEN, H.: Atrial natriuretic peptide inhibits the agonist-induced increase in extent of myosin light chain phosphorylation in aortic smooth muscle. *J. Biol. Chem.* **263**: 13117-13120, 1988.
- PARKER, I., ITO, Y., KURIYAMA, H., AND MILEDI, R.: β -Adrenergic agonists and cyclic AMP decrease intracellular resting free-calcium concentration in ileum smooth muscle. *Proc. R. Soc. Lond. Ser. B. Biol. Sci.* **230**: 207-214, 1987.
- PARKINSON, N. A., AND HUGHES, A. D.: The mechanism of action of α_2 -adrenoceptors in human isolated subcutaneous resistance arteries. *Br. J. Pharmacol.* **115**: 1463-1468, 1995.
- PAUL, R. J.: Contractility of muscles. *In* Cell Physiology Source Book, ed. by N. Sperelakis, pp. 592-610, Academic Press, San Diego, 1995.
- PEACH, M. J., SINGER, H. A., IZZO, N. J. JR., AND LOEB, A. L.: Role of calcium in endothelium-dependent relaxation of arterial smooth muscle. *Am. J. Cardiol.* **59**: 35A-43A, 1987.
- PEIPER, U., GRIEBEL, L., AND WENDE, W.: Activation of vascular smooth muscle of rat aorta by noradrenaline and depolarization: two different mechanisms. *Pfluegers Arch.* **330**: 74-89, 1971.
- PETERSEN, C. C. H., AND BERRIDGE, M. J.: Capacitative calcium entry is colocalised with calcium release in *Xenopus* oocytes: evidence against a highly diffusible calcium influx factor. *Pfluegers Arch.* **432**: 286-292, 1996.
- PETERSEN, T. T., AND MULVANY, M. J.: Effect of sodium gradient on the rate of relaxation of rat mesenteric small arteries from potassium contractures. *Blood Vessels* **21**: 279-289, 1984.
- PFITZER, G.: Permeabilized smooth muscle. *In* Biochemistry of Smooth Muscle Contraction, ed. by M. Barany, pp. 191-199, Academic Press, New York, 1996.
- PIJUAN, V., AND LITOSCH, I.: Norepinephrine stimulates the production of inositol trisphosphate and inositol tetrakisphosphate in rat aorta. *Biochem. Biophys. Res. Commun.* **156**: 240-245, 1988.
- PIJUAN, V., SUKHOLUTSKAYA, I., KERRICK, W. G., LAM, M., VAN BREEMEN, C., AND LITOSCH, I.: Rapid stimulation of $\text{Ins}(1,4,5)\text{P}_3$ production in rat aorta by norepinephrine: correlation with contractile state. *Am. J. Physiol.* **264**: H126-H132, 1993.
- POCH, G., AND UMFABER, W.: Differentiation of intestinal smooth muscle relaxation caused by drugs that inhibit phosphodiesterase. *Naunyn-Schmiedeberg's Arch. Pharmacol.* **293**: 257-268, 1976.
- POLSON, J. B., KRZANOWSKI, J. J., FITZPATRICK, D. F., AND SZNETIVANYI, A.: Studies on the inhibition of phosphodiesterase-catalyzed cyclic AMP and cyclic GMP breakdown and relaxation of canine tracheal smooth muscle. *Biochem. Pharmacol.* **27**: 254-256, 1978.
- POPESCU, L. M., AND IGNAT, P.: Calmodulin-dependent Ca^{2+} pump ATPase of human smooth muscle sarcolemma. *Cell Calcium* **4**: 219-235, 1983.
- POYNER, D.: Pharmacology of receptors for calcitonin gene-related peptide and amylin. *Trends Pharmacol. Sci.* **16**: 424-428, 1995.
- PRITCHARD, K., AND ASHLEY, C. C.: $\text{Na}^+/\text{Ca}^{2+}$ exchange in isolated smooth muscle cells demonstrated by the fluorescent calcium indicator fura-2. *FEBS Lett.* **195**: 23-27, 1986.
- PRITCHARD, K., AND ASHLEY, C. C.: Evidence for $\text{Na}^+/\text{Ca}^{2+}$ exchange in isolated smooth muscle cells: a fura-2 study. *Pfluegers Arch.* **410**: 401-407, 1987.
- PUBLICOVER, N. G., HOROWITZ, N. N., AND SANDERS, K. M.: Calcium oscillations in freshly dispersed and cultured interstitial cells from canine colon. *Am. J. Physiol.* **262**: C589-C597, 1992.
- PUTNEY, J. W., AND BIRD, G. S.: The inositol phosphate-calcium signaling system in nonexcitable cells. *Endocr. Rev.* **14**: 610-613, 1993.
- PUTNEY, J. W., JR.: Capacitative calcium entry revisited. *Cell Calcium* **7**: 611-624, 1990.
- RAEYMAEKERS, L., AND WUYTACK, F.: Calcium pumps. *In* Biochemistry of Smooth Muscle Contraction, ed. by M. Barany, pp. 241-253, Academic Press, New York, 1996.
- RAEYMAEKERS, L., WUYTACK, F., AND CASTEELS, R.: Subcellular fractionation of pig stomach smooth muscle: a study of the distribution of the $(\text{Ca}^{2+} + \text{Mg}^{2+})\text{-ATPase}$ activity in plasmalemma and endoplasmic reticulum. *Biochim. Biophys. Acta* **815**: 441-454, 1985.
- RANDRIAMAMPITA, C., AND TSIEN, R. Y.: Emptying of intracellular Ca^{2+} stores releases a novel small messenger that stimulates Ca^{2+} influx. *Nature (Lond.)* **364**: 809-814, 1993.
- RANDRIAMAMPITA, C., AND TSIEN, R. Y.: Degradation of a calcium influx factor (CIF) can be blocked by phosphatase inhibitor or chelation of Ca^{2+} . *J. Biol. Chem.* **270**: 29-32, 1995.
- RAPOPORT, R. M., CAMBELL, A. K., AND BAZAN, E.: Effects of PKC downregulation on norepinephrine- and prostaglandin $\text{F}_2\alpha$ -induced contraction in rat aorta. *Am. J. Physiol.* **269**: H590-H598, 1995.
- RASMUSSEN, H., TAKUWA, Y., AND PARK, S.: Protein kinase C in the regulation of smooth muscle contraction. *FASEB J.* **1**: 177-185, 1987.
- REMBOLD, C. M.: Modulation of the $[\text{Ca}^{2+}]$ sensitivity of myosin phosphorylation in intact swine arterial smooth muscle. *J. Physiol. (Lond.)* **429**: 77-94, 1990.

- REMBOLD, C. M.: Electromechanical and pharmacomechanical coupling. *In* Biochemistry of Smooth Muscle Contraction, ed. by M. Barany, pp. 227–239, Academic Press, New York, 1996.
- REMBOLD, C. M., AND MURPHY, R. A.: $[Ca^{2+}]$ -dependent myosin phosphorylation in phorbol diester stimulated smooth muscle contraction. *Am. J. Physiol.* **255**: C719–C723, 1988a.
- REMBOLD, C. M., AND MURPHY, R. A.: Myoplasmic $[Ca^{2+}]$ determines myosin phosphorylation in agonist-stimulated swine arterial smooth muscle. *Circ. Res.* **63**: 593–603, 1988b.
- REMBOLD, C. M., AND WEAVER, B. A.: $[Ca^{2+}]$, not diacylglycerol, is the primary regulator of sustained swine arterial smooth muscle contraction. *Hypertension* **15**: 692–698, 1990.
- REMBOLD, C. M., RICHARD, H., AND CHEN, X. L.: Na^+ - Ca^{2+} exchange, myoplasmic Ca^{2+} concentration and contraction of arterial smooth muscle. *Hypertension* **19**: 308–313, 1992.
- REMBOLD, C. M., VAN RIPER, D. A., AND CHEN, X. L.: Focal $[Ca^{2+}]_i$ increases detected by aequorin but not by fura-2 in histamine- and caffeine-stimulated swine carotid artery. *J. Physiol. (Lond.)* **488**: 549–564, 1995.
- REMBOLD, C. M., WEAVER, B. A., AND LINDEN, J.: Adenosine triphosphate induces a low $[Ca^{2+}]_i$ sensitivity of phosphorylation and an unusual form of receptor desensitization in smooth muscle. *J. Biol. Chem.* **266**: 5407–5411, 1991.
- RESNICK, M. S., MAITLAND, L. A., AND MORGAN, K. G.: Flosequin, a vasodilator with a novel mechanism of action. *Br. J. Pharmacol.* **102**: 974–978, 1991.
- REUTER, H., BLAUSTEIN, M. P., AND HAEUSLER, G.: Na-Ca exchange and tension development in arterial smooth muscle. *Philos. Trans. R. Soc. Lond. B. Biol. Sci.* **265**: 87–94, 1973.
- REYNOLDS, E. E., AND DUBYAK, G. R.: Agonist-induced calcium transients in cultured smooth muscle cells: measurements with fura-2 loaded monolayers. *Biochem. Biophys. Res. Commun.* **136**: 927–934, 1986.
- RIDGWAY, E. B., AND ASHLEY, C. C.: Calcium transients in single muscle fibers. *Biochem. Biophys. Res. Commun.* **29**: 229–234, 1967.
- RIZZUTO, R., BASTIANUTTO, C., BRINI, M., MURGIA, M., AND POZZAN, T.: Mitochondrial Ca^{2+} homeostasis in intact cells. *J. Cell Biol.* **126**: 1183–1194, 1994.
- RIZZUTO, R., SIMPSON, A. W. M., BRINI, M., AND POZZAN, T.: Rapid changes of mitochondrial calcium revealed by specifically targeted recombinant aequorin. *Nature (Lond.)* **358**: 325–327, 1992.
- RUBART, M., PATLAK, J. B., AND NELSON, M. T.: Ca^{2+} currents in cerebral artery smooth muscle cells of rat at physiological Ca^{2+} concentrations. *J. Gen. Physiol.* **107**: 459–472, 1966.
- RUEGG, U. T., WALLNOFER, A., WEIR, S., AND CAUVIN, C.: Receptor-operated calcium-permeable channels in vascular smooth muscle. *J. Cardiovasc. Pharmacol.* **14**(suppl. 6): S49–S58, 1989.
- RUSKO, J., VAN SLOOTEN, G., AND ADAMS, D. J.: Caffeine-evoked, calcium-sensitive membrane currents in rabbit aortic endothelial cells. *Br. J. Pharmacol.* **115**: 133–141, 1995a.
- RUSKO, J., WANG, X., AND VAN BREEMEN, C.: Regenerative caffeine-induced responses in native rabbit aortic endothelial cells. *Br. J. Pharmacol.* **115**: 811–821, 1995b.
- RUZYCKY, A. L., AND MORGAN, K. G.: Involvement of the protein kinase C system in calcium-force relationships in ferret aorta. *Br. J. Pharmacol.* **97**: 391–400, 1989.
- RYAN, U. S., AVDONIN, P. V., POSIN, E. Y., POPOV, E. G., DANILOV, S. M., AND TKACHUK, V. A.: Influence of vasoactive agents on cytosolic free calcium in vascular endothelial cells. *J. Appl. Physiol.* **65**: 2221–2227, 1988.
- SADA, T., KOIKE, H., IKEDA, M., SATO, K., OZAKI, H., AND KARAKI, H.: Cytosolic free calcium of aorta in hypertensive rats: effects of chronic inhibition of angiotensin converting enzyme. *Hypertension* **16**: 245–251, 1990.
- SAGE, S. O., VAN BREEMEN, C., AND CANNELL, M. B.: Sodium-calcium exchange in cultured bovine pulmonary artery endothelial cells. *J. Physiol. (Lond.)* **440**: 569–580, 1991.
- SAIDA, K.: Intracellular Ca release in skinned smooth muscle. *J. Gen. Physiol.* **80**: 191–202, 1982.
- SAITO, S., AND KARAKI, H.: A family of novel actin-inhibiting marine toxins. *Clin. Exp. Pharmacol. Physiol.* **23**: 743–746, 1996.
- SAITO, S., HORI, M., OZAKI, H., AND KARAKI, H.: Cytochalasin D inhibits smooth muscle contraction by directly inhibiting contractile apparatus. *J. Smooth Muscle Res.* **32**: 51–60, 1996.
- SAITO, S., WATABE, S., OZAKI, H., FUSEYANI, N., AND KARAKI, H.: Mycalolide B, a novel actin depolymerizing agent. *J. Biol. Chem.* **269**: 29710–29714, 1994.
- SAKAGUCHI, H., ANAI, N., MIYAMOTO, A., ISHIGURO, S., AND NISHIO, A.: Mechanisms of the enhanced contractile response to a low concentration of phorbol 12,13-dibutyrate in thoracic aorta isolated from rats with dietary magnesium deficiency. *Jpn. J. Pharmacol.* **67**: 9–13, 1995.
- SAKAGUCHI, H., AND NISHIO, A.: Mechanisms of the enhanced contractile response to phenylephrine in thoracic aorta isolated from rats with dietary magnesium deficiency. *Jpn. J. Pharmacol.* **64**: 265–272, 1994.
- SAKAI, K., YAMAGISHI, T., AND UCHIDA, M. K.: Intracellular site of "calcium reversal": inhibition of uterine smooth muscle contraction in calcium-free medium by a minute amount of calcium ion released from mitochondria by drugs. *Gen. Pharmacol.* **17**: 151–156, 1986.
- SAKAI, T., TERADA, K., KITAMURA, K., AND KURIYAMA, H.: Ryanodine inhibits the Ca-dependent K current after depletion of Ca stored in smooth muscle cells of the rabbit ileal longitudinal muscle. *Br. J. Pharmacol.* **95**: 1089–1100, 1988.
- SAKATA, K., AND KARAKI, H.: Effects of a novel smooth muscle relaxant, KT-362, on contraction and cytosolic Ca^{2+} level in the rat aorta. *Br. J. Pharmacol.* **102**: 174–178, 1991.
- SAKATA, K., AND KARAKI, H.: Effects of endothelin on cytosolic calcium level and mechanical activity in rat uterine smooth muscle. *Eur. J. Pharmacol.* **221**: 9–15, 1992.
- SAKATA, K., OZAKI, H., KWON, S. C., AND KARAKI, H.: Effects of endothelin on the mechanical activity and cytosolic calcium level of various types of smooth muscle. *Br. J. Pharmacol.* **98**: 483–492, 1989.
- SALOMONE, S., MOREL, N., AND GODFRAIND, T.: Effects of 8-bromo cyclic GMP and verapamil on depolarization-evoked Ca^{2+} signal and contraction in rat aorta. *Br. J. Pharmacol.* **114**: 1731–1737, 1995.
- SANAGI, M., OZAKI, H., MITSUI, M., AND KARAKI, H.: Mechanism of relaxing action of the antiasthmatic drug, azelastine, in isolated porcine tracheal smooth muscle. *Eur. J. Pharmacol.* **222**: 247–255, 1992.
- SANDERS, K. M.: A case for interstitial cells of cajal as pacemakers and mediators of neurotransmission in the gastrointestinal tract. *Gastroenterology* **111**: 492–515, 1996.
- SANDERS, K. M., AND OZAKI, H.: Excitation-contraction coupling in gastrointestinal smooth muscle. *In* Pharmacology of Smooth Muscle, ed. by L. Szekeres, and J. G. Papp, pp. 331–404, Springer-Verlag, Berlin, 1994.
- SANDERS, K. M., AND WARD, S. M.: Nitric oxide as a mediator of nonadrenergic noncholinergic neurotransmission. *Am. J. Physiol.* **262**: G379–G392, 1992.
- SANDIRASEGARANE, L., AND GOPALAKRISHNAN, V.: Vanadate increases cytosolic free calcium in rat aortic smooth muscle cells. *Life Sci.* **56**: PL169–PL174, 1995.
- SASAKI, F., OSUGI, S., SHIMAMURA, K., AND SUNANO, S.: Relationship between blood pressure and smooth muscle tone in aortae of hypertensive rats: role of $[Ca^{2+}]_i$. *J. Smooth Muscle Res.* **29**: 69–79, 1993.
- SASAKI, H., AND OKABE, E.: Modification by hydroxyl radicals of functional reactivity in rabbit lingual artery. *Jpn. J. Pharmacol.* **62**: 305–314, 1993.
- SASAKI, H., NAKAMURA, M., OHNO, T., MATSUDA, Y., YUDA, Y., AND NONOMURA, Y.: Myosin-actin interaction plays an important role in human immunodeficiency virus type 1 release from host cells. *Proc. Natl. Acad. Sci. USA* **92**: 2026–2030, 1995.
- SATO, K., HORI, M., OZAKI, H., TAKANO-OHMURO, H., TSUCHIYA, T., SUGI, H., AND KARAKI, H.: Myosin phosphorylation-independent contraction induced by phorbol ester in vascular smooth muscle. *J. Pharmacol. Exp. Ther.* **261**: 497–505, 1992.
- SATO, K., LEPOSAVIC, R., PUBLICOVER, N. G., SANDERS, K. M., AND GERTHOFFER, W. T.: Sensitization of the contractile system of canine colonic smooth muscle by agonists and phorbol ester. *J. Physiol. (Lond.)* **481**: 677–688, 1994a.
- SATO, K., OZAKI, H., AND KARAKI, H.: Changes in cytosolic calcium level in vascular smooth muscle strip measured simultaneously with contraction using fluorescent calcium indicator fura 2. *J. Pharmacol. Exp. Ther.* **246**: 294–300, 1988a.
- SATO, K., OZAKI, H., AND KARAKI, H.: Multiple effects of caffeine on contraction and cytosolic free calcium levels in vascular smooth muscle of rat aorta. *Naunyn-Schmiedeberg's Arch. Pharmacol.* **338**: 443–448, 1988b.
- SATO, K., OZAKI, H., AND KARAKI, H.: Differential effects of carbachol on cytosolic calcium levels in vascular endothelium and smooth muscle. *J. Pharmacol. Exp. Ther.* **255**: 114–119, 1990.
- SATO, K., SANDERS, K. M., GERTHOFFER, W. T., AND PUBLICOVER, N. G.: Sources of calcium utilized in cholinergic responses in canine colonic smooth muscle. *Am. J. Physiol.* **267**: C1666–C1673, 1994b.
- SATO, M., KOJIMA, C., KOKUBU, N., AND TAKAYANAGI, I.: α_1 -Adrenoceptor subtypes mediating the regulation and modulation of Ca^{2+} sensitization in rabbit thoracic aorta. *Eur. J. Pharmacol.* **265**: 133–139, 1994.
- SATO, M., KOKUBU, N., MATSUO, K., AND TAKAYANAGI, I.: α_{1A} -Adrenoceptor subtype effectively increases Ca^{2+} -sensitivity for contraction in rabbit thoracic aorta. *Gen. Pharmacol.* **26**: 357–362, 1995.
- SATO, S., FUJIWARA, T., NISHIYE, E., SUMIMOTO, K., ITOH, T., SUZUKI, H., AND KURIYAMA, H.: Actions of a newly synthesized nitro-compound, E-4701, on rabbit vascular smooth muscles. *Jpn. J. Pharmacol.* **51**: 357–368, 1989.
- SATO, S., ITOH, T., AND KURIYAMA, H.: Actions of angiotensin II and noradrenaline on smooth muscle cells of the canine mesenteric artery. *Pflügers Arch.* **410**: 132–138, 1987.
- SATO, T., MORIYAMA, T., KURIKI, H., AND KARAKI, H.: Calcium channel blocker-like action of reserpine in smooth muscle. *Jpn. J. Pharmacol.* **60**: 291–293, 1992.
- SAURO, M. D., AND THOMAS, B.: Tyrothostin attenuates platelet-derived growth factor-induced contraction in aortic smooth muscle through inhibition of protein tyrosine kinase(s). *J. Pharmacol. Exp. Ther.* **267**: 1119–1125, 1993.
- SAURO, M. D., SUDAKOW, R., AND BURNS, S.: In vivo effects of angiotensin II on vascular smooth muscle contraction and blood pressure are mediated through a protein tyrosine-kinase-dependent mechanism. *J. Pharmacol. Exp. Ther.* **277**: 1744–1750, 1996.
- SAVINEAU, J. P.: Caffeine does not contract skinned uterine fibers with a functional calcium store. *Eur. J. Pharmacol.* **149**: 187–190, 1988.
- SCANLON, M., WILLIAMS, D. A., AND FAY, F. S.: A Ca^{2+} -insensitive form of fura-2 associated with polymorphonuclear leukocytes. Assessment and accurate Ca^{2+} measurement. *J. Biol. Chem.* **262**: 6308–6312, 1987.

- SCHACHTER, J. B., IVINS, J. K., PITTMAN, R. N., AND WOLFE, B. B.: Competitive regulation of phospholipase C responses by cAMP and calcium. *Mol. Pharmacol.* **41**: 577-586, 1992.
- SCHILLING, W. P., AND ELLIOTT, S. J.: Ca^{2+} signaling mechanisms of vascular endothelial cells and their role in oxidant-induced endothelial cell dysfunction. *Am. J. Physiol.* **262**: H1617-H1630, 1992.
- SCHILLING, W. P., CABELLO, O. A., AND RAJAN, L.: Depletion of the inositol 1,4,5-trisphosphate-sensitive intracellular Ca^{2+} store in vascular endothelial cells activates the agonist-sensitive Ca^{2+} -influx pathway. *Biochem. J.* **248**: 521-530, 1992.
- SCHMIDT, K., MAYER, B., AND KUKOVETZ, W. R.: Effect of calcium on endothelium-derived relaxing factor formation and cGMP levels in endothelial cells. *Eur. J. Pharmacol.* **170**: 157-166, 1989.
- SCHMIDT, K., REICH, R., AND KUKOVETZ, W. R.: Stimulation of coronary guanylate cyclase by nicorandil (SG-75) as a mechanism of its vasodilating action. *J. Cyc. Nucl. Res.* **10**: 43-53, 1985.
- SCHNEIDER, P., HOPP, H. H., AND ISENBERG, G.: Ca^{2+} influx through ATP-gated channels increments $[Ca^{2+}]_i$ and inactivates I_{Ca} in myocytes from guinea-pig urinary bladder. *J. Physiol. (Lond.)* **440**: 479-496, 1991.
- SCHWARZ, G., CALLEWAERT, G., DROOGMANS, G., AND NILIUS, B.: Shear stress-induced calcium transients in endothelial cells from human umbilical cord veins. *J. Physiol. (Lond.)* **458**: 527-538, 1992.
- SCHWORER, C. M., AND SINGER, H. A.: Purification of protein kinase C and identification of isozymes in vascular smooth muscle. *Adv. Exp. Med. Biol.* **304**: 353-361, 1991.
- SEGUCHI, H., NISHIMURA, J., KOBAYASHI, S., KUMAZAWA, J., AND KANAIDE, H.: Autocrine regulation of the renal arterial tone by adrenomedullin. *Biochem. Biophys. Res. Commun.* **215**: 619-625, 1995.
- SEIDEL, C. L., AND BOHR, D. F.: Calcium and vascular smooth muscle contraction. *Circ. Res.* **28**(suppl. 2): 88-95, 1971.
- SEIDLER, N. W., VEGH, M., AND MARTONOSI, A.: Cyclopiazonic acid is a specific inhibitor of the Ca^{2+} -ATPase of sarcoplasmic reticulum. *J. Biol. Chem.* **264**: 17816-17823, 1989.
- SEKIGUCHI, F., SHIMAMURA, K., AND SUNANO, S.: Effects of cyclopiazonic acid and thapsigargin on electrochemical activities and intracellular Ca^{2+} in smooth muscle of carotid artery of hypertensive rats. *Br. J. Pharmacol.* **118**: 857-864, 1996.
- SEMENCHUK, L. A., AND DI SALVO, J.: Receptor-activated increases in intracellular calcium and protein tyrosine phosphorylation in vascular smooth muscle cells. *FEBS Lett.* **370**: 127-130, 1995.
- SETO, M., SASAKI, Y., HIDAKA, H., AND SASAKI, Y.: Effects of HA1077, a protein kinase inhibitor, on myosin phosphorylation and tension in smooth muscle. *Eur. J. Pharmacol.* **195**: 267-272, 1991.
- SHASBY, D. M., AND SHASBY, S. S.: Effect of calcium on transendothelial albumin transfer and electrical resistance. *J. Appl. Physiol.* **60**: 71-79, 1986.
- SHIBATA, S., ISHIDA, Y., KITANO, H., OHIZUMI, Y., HABON, J., TSUKITANI, Y., AND KIKUCHI, H.: Contractile effects of okadaic acid, a novel ionophore-like substance from black sponge, on isolated smooth muscles under the condition of Ca deficiency. *J. Pharmacol. Exp. Ther.* **223**: 135-143, 1982.
- SHIBATA, S., SATAKE, N., MORIKAWA, M., KOWN, S. C., KARAKI, H., KURAHASHI, K., SAWADA, T., AND KODAMA I.: The inhibitory action of okadaic acid on mechanical responses in guinea-pig vas deferens. *Eur. J. Pharmacol.* **193**: 1-7, 1991.
- SHIEH, C. C., PETRINI, M. F., DWYER, T. M., AND FARLEY, J. M.: Concentration-dependence of acetylcholine-induced changes in calcium and tension in swine trachealis. *J. Pharmacol. Exp. Ther.* **256**: 141-148, 1991.
- SHIEH, C. C., PETRINI, M. F., DWYER, T. M., AND FARLEY, J. M.: Cromakalim effects of acetylcholine-induced changes in cytosolic calcium and tension in swine trachealis. *J. Pharmacol. Exp. Ther.* **260**: 261-268, 1992.
- SHIGENOBU, K., SCHNEIDER, J. A., AND SPERELAKIS, N.: Verapamil blockade of slow Na^{+} and Ca^{++} responses in myocardial cells. *J. Pharmacol. Exp. Ther.* **190**: 280-288, 1974.
- SHIMADA, T., SHIMAMURA, K., AND SUNANO, S.: Effects of sodium vanadate on various types of vascular smooth muscles. *Blood Vessels* **23**: 113-124, 1986.
- SHIMAMOTO, Y., SHIMAMOTO, H., KWAN, C. Y., AND DANIEL, E. E.: Differential effects of putative protein kinase C inhibitors on contraction of rat aortic smooth muscle. *Am. J. Physiol.* **264**: H1300-H1306, 1993.
- SHIMIZU, H., ITO, M., MIYAHARA, M., ICHIKAWA, K., OKUBO, S., KONISHI, T., NAKA, M., TANAKA, T., HIRANO, K., HARTSHORNE, D. J., AND NAKANO, T.: Characterization of the myosin-binding subunit of smooth muscle myosin phosphatase. *J. Biol. Chem.* **269**: 30407-30411, 1994.
- SHIMIZU, K., KABURAGI, T., NAKAJYO, S., AND URAKAWA, N.: Decrease in muscle tension and reduced pyridine nucleotides of the guinea-pig ileal longitudinal smooth muscle in high K^{+} , Na^{+} -deficient solution. *Jpn. J. Pharmacol.* **56**: 53-59, 1991.
- SHIMIZU, K., KANEDA, T., CHIHARA, H., KABURAGI, T., NAKAJYO, S., AND URAKAWA, N.: Effects of phenylephrine on the contractile tension and cytosolic Ca^{2+} level in rat anococcygeus muscle. *J. Smooth Muscle Res.* **31**: 163-173, 1995.
- SHIMOMURA, O., JOHNSON, F. H., AND SAIGA, Y.: Extraction, purification and properties of aequorin, a bioluminescent protein from the luminous hydromedusa. *J. Cell. Comp. Physiol.* **59**: 223-239, 1962.
- SHIN, W. S., KAWAGUCHI, H., SASAKI, T., WANG, Y. P., YANG, W. D., INUKAI, M., AND TOYO-OKA, T.: The role of nitric oxide in the cardiovascular system. *Ann. N. Y. Acad. Sci.* **786**: 233-244, 1996.
- SHIN, W. S., SASAKI, T., KATO, M., HARA, K., SEKO, A., YANG, W. D., SHIMAMOTO, N., SUGIMOTO, T., AND TOYO-OKA, T.: Autocrine and paracrine effects of endothelium-derived relaxing factor on intracellular Ca^{2+} of endothelial cells and vascular smooth muscle cells: identification by two-dimensional image analysis in coculture. *J. Biol. Chem.* **267**: 20377-20382, 1992.
- SHIN, W. S., TOYO-OKA, T., MASUO, M., OKAI, Y., FUJITA, H., AND SUGIMOTO, T.: Subpopulations of rat vascular smooth muscle cells as discriminated by calcium release mechanisms from internal stores. *Circ. Res.* **69**: 551-556, 1991.
- SHORT, A. D., BIAN, J., GHOSH, T. K., WALDRON, R. T., RYBAK, S. L., AND GILL, D. L.: Intracellular Ca^{2+} pool content is linked to control of cell growth. *Proc. Natl. Acad. Sci. USA* **90**: 4986-4990, 1993.
- SIGURDSON, W. J., SACHS, F., AND DIAMOND, S. L.: Mechanical perturbation of cultured human endothelial cells causes rapid increases of intracellular calcium. *Am. J. Physiol.* **264**: H1745-H1752, 1993.
- SILL, J. C., UHL, C., ESKURI, S., VAN DYKE, R., AND TARARA, J.: Halothane inhibits agonist-induced inositol phosphate and Ca^{2+} signaling in A7r5 cultured vascular smooth muscle cells. *Mol. Pharmacol.* **40**: 1006-1013, 1991.
- SIMONEAU, C., THURINGER, D., CAI, S., GARNEAU, L., BLAISE, G., AND SAUVE, R.: Effects of halothane and isoflurane on bradykinin-evoked Ca^{2+} influx in bovine aortic endothelial cells. *Anesthesiology* **85**: 366-379, 1996.
- SIMPSON, A. W., AND ASHLEY, C. C.: Endothelin evoked Ca^{2+} transients and oscillations in A10 vascular smooth muscle cells. *Biochem. Biophys. Res. Commun.* **163**: 1223-1229, 1989a.
- SIMPSON, A. W., AND ASHLEY, C. C.: Spontaneous oscillations and agonist-evoked changes in Ca^{2+} in cultured smooth muscle cells. *J. Cardiovasc. Pharmacol.* **14**(suppl. 6): 59-62, 1989b.
- SIMPSON, A. W., STAMPFL, A., AND ASHLEY, C. C.: Evidence for receptor-mediated bivalent-cation entry in A10 vascular smooth-muscle cells. *Biochem. J.* **267**: 277-280, 1990.
- SINGER, H. A.: Protein kinase C. *In Biochemistry of Smooth Muscle Contraction*, ed. by M. Barany, pp. 155-165, Academic Press, New York, 1996.
- SISKIND, M. S., MCCOY, C. E., CHOBANIAN, A., AND SCHWARTZ, J. H.: Regulation of intracellular calcium by cell pH in vascular smooth muscle cells. *Am. J. Physiol.* **256**: C234-C240, 1989.
- SLAUGHTER, R., SHEVERLL, J. L., FELIX, J. P., GARCIA, M. L., AND KACZOROWSKI, G. J.: High levels of sodium-calcium exchange in vascular smooth muscle sarcolemmal membrane vesicles. *Biochemistry* **28**: 3995-4002, 1989.
- SLAUGHTER, R., WELTON, A. F., AND MORGAN, D. W.: Sodium-calcium exchange in sarcolemmal vesicles from tracheal smooth muscle. *Biochim. Biophys. Acta* **904**: 92-104, 1987.
- SLODZINSKI, M. K., JUHASZOVA, M., AND BLAUSTEIN, M. P.: Antisense inhibition of Na^{+}/Ca^{2+} exchange in primary cultured arterial myocytes. *Am. J. Physiol.* **269**: C1340-C1345, 1995.
- SMIRNOV, S. V., AND AARONSON, P. I.: Inhibition of vascular smooth muscle cell K^{+} currents by tyrosine kinase inhibitors genistein and ST 638. *Circ. Res.* **76**: 310-316, 1995.
- SOBUE, K., AND SELLERS, J. R.: Caldesmon, a novel regulatory protein in smooth muscle and nonmuscle actomyosin system. *J. Biol. Chem.* **266**: 12115-12118, 1991.
- SOBUE, K., MORIMOTO, K., KANDA, M., FUKUNAGA, E., MIYAMOTO, E., AND KAKIUCHI, S.: Interaction of 13500 Mr calmodulin binding protein (myosin kinase) and F-actin: another Ca^{2+} - and calmodulin dependent flip flop switch. *Biochem. Int.* **5**: 503-510, 1982.
- SOBUE, K., MURAMOTO, Y., FUJITA, M., AND KAKIUCHI, S.: Purification of a calmodulin-binding protein from chicken gizzard that interests with F-actin. *Proc. Natl. Acad. Sci. USA* **78**: 5652-5655, 1981.
- SOMLYO, A. V.: Ultrastructure of vascular smooth muscle. *In The Handbook of Physiology: The Cardiovascular System*, ed. by D. F. Bohr, A. P. Somlyo, and H. V. Sparks, vol. 3, pp. 33-67, American Physiological Society, Bethesda, Maryland, 1980.
- SOMLYO, A. P., AND HIMPENS, B.: Cell calcium and its regulation in smooth muscle. *FASEB J.* **3**: 2266-2276, 1989.
- SOMLYO, A. P., AND SOMLYO, A. V.: Vascular smooth muscle. I. Normal structure, pathology, biochemistry, and biophysics. *Pharmacol. Rev.* **20**: 197-272, 1968.
- SOMLYO, A. P., AND SOMLYO, A. V.: Signal transduction and regulation in smooth muscle. *Nature (Lond.)* **372**: 231-236, 1994.
- SOMLYO, A. P., KITAZAWA, T., HIMPENS, B., MATHJS, B., HORIUCHI, K., KOBAYASHI, S., GOLDMAN, Y. E., AND SOMLYO, A. V.: Modulation of Ca^{2+} sensitivity and of the time course of contraction in smooth muscle: a major role of protein phosphatases. *In Advances in Protein Phosphatases*, ed. by W. Merlevede, and J. Di Salvo, pp. 181-195, University Press, London, 1989.
- SOMLYO, A. V., BOND, M., SOMLYO, A. P., AND SCARPA, A.: Inositol trisphosphate-induced calcium release and contraction in vascular smooth muscle. *Proc. Natl. Acad. Sci. USA* **82**: 5231-5235, 1985.
- SPAMPINATO, S., BACHETTI, T., CARBONI, L., RATTI, E., VAN AMSTERDAM, F. T., AND FERRI, S.: Ca^{2+} channel blocking activity of lacidipine and amlodipine in A7r5 vascular smooth muscle cells. *Eur. J. Pharmacol.* **244**: 139-144, 1993.
- STARK, M. E., AND SZURSZEWski, J. H.: Role of nitric oxide in gastrointestinal and hepatic functions and disease. *Gastroenterology* **103**: 1928-1949, 1992.
- STEHNO-BITTEL, L., AND STUREK, M.: Spontaneous sarcoplasmic reticulum

- calcium release and extrusion from bovine, not porcine, coronary artery smooth muscle. *J. Physiol. (Lond.)* **451**: 49–78, 1992.
- STEUSLOFF, A., PAUL, E., SEMENCHUK, L. A., DI SALVO, J., AND PFITZER, G.: Modulation of Ca^{2+} sensitivity in smooth muscle by genistein and protein tyrosine phosphorylation. *Arch. Biochem. Biophys.* **320**: 236–242, 1995.
- STOUT, M. A.: Calcium transport by sarcoplasmic reticulum of vascular smooth muscle: I. Magnesium ATP-dependent and magnesium ATP-independent calcium uptake. *J. Cell Physiol.* **149**: 383–395, 1991.
- STOUT, M. A., AND DIECKE, F. P.: ^{45}Ca distribution and transport in saponin skinned vascular smooth muscle. *J. Pharmacol. Exp. Ther.* **225**: 102–111, 1983.
- STRAUSS, J. D., AND MURPHY, R. A.: Regulation of cross-bridge cycling in smooth muscle. In *Biochemistry of Smooth Muscle Contraction*, ed. by M. Barany, pp. 341–353, Academic Press, New York, 1996.
- STULL, J. T., GALLAGHER, P. J., HERRING, B. P., AND KAMM, K. E.: Vascular smooth muscle contractile elements: cellular regulation. *Hypertension* **17**: 723–732, 1991.
- STULL, J. T., HSU, L.-C., TANSEY, M. G., AND KAMM, K. E.: Myosin light chain kinase phosphorylation in tracheal smooth muscle. *J. Biol. Chem.* **265**: 16683–16690, 1990.
- STUREK, M., KUNDA, K., AND HU, Q.: Sarcoplasmic reticulum buffering of myoplasmic calcium in bovine coronary artery smooth muscle. *J. Physiol. (Lond.)* **451**: 25–48, 1992.
- SU, J. Y.: Mechanisms of action of isoflurane on contraction of rabbit conduit artery. *Anesth. Analg.* **82**: 837–842, 1996.
- SU, J. Y., AND ZHANG, C. C.: Intracellular mechanisms of halothane's effect on isolated aortic strips of the rabbit. *Anesthesiology* **71**: 409–417, 1989.
- SU, J. Y., CHANG, Y. I., AND TANG, L. J.: Mechanisms of action of enflurane on vascular smooth muscle: comparison of rabbit aorta and femoral artery. *Anesthesiology* **81**: 700–709, 1994.
- SU, X., KATOCH, S. S., AND MORELAND, R. S.: Cyclic nucleotides relax contractions of α -toxin permeabilized arteries without a proportional change in myosin light chain phosphorylation (abstract). *Biophys. J.* **70**: 385, 1996.
- SUDJARWO, S. A., AND KARAKI, H.: Role of protein kinase C on the endothelin-induced contraction in the rabbit saphenous vein. *Eur. J. Pharmacol.* **294**: 261–269, 1995.
- SUDJARWO, S. A., HORI, M., AND KARAKI, H.: Effect of endothelin-3 on cytosolic calcium level in vascular endothelium and on smooth muscle contraction. *Eur. J. Pharmacol.* **229**: 137–142, 1992.
- SUDJARWO, S. A., HORI, M., TANAKA, T., MATSUDA, Y., OKADA, T., AND KARAKI, H.: Coupling of the endothelin ET_A and ET_B receptors to calcium mobilization and calcium sensitization in vascular smooth muscle. *Eur. J. Pharmacol. Mol. Pharmacol. Sect.* **289**: 197–204, 1995.
- SUEMATSU, E., HIRATA, M., HASHIMOTO, T., AND KURUYAMA, H.: Inositol 1,4,5-trisphosphate releases Ca^{2+} from intracellular store sites in skinned cells of porcine coronary artery. *Biochem. Biophys. Res. Commun.* **120**: 481–485, 1984.
- SUEMATSU, E., RESNICK, M., AND MORGAN, K. G.: Ca^{2+} -independent change in phosphorylation of the myosin light chain during relaxation of ferret aorta by vasodilators. *J. Physiol. (Lond.)* **440**: 85–93, 1991a.
- SUEMATSU, E., RESNICK, M., AND MORGAN, K. G.: Change of Ca^{2+} requirement for myosin phosphorylation by prostaglandin $F_{2\alpha}$. *Am. J. Physiol.* **261**: C253–C258, 1991b.
- SUGIYAMA, T., AND GOLDMAN, W. F.: Measurement of SR free Ca^{2+} and Mg^{2+} in permeabilized smooth muscle cells with use of fura-2. *Am. J. Physiol.* **269**: C698–C705, 1995.
- SUMIMOTO, K., AND KURIYAMA, H.: Mobilization of free Ca^{2+} measured during contraction-relaxation cycles in smooth muscle cells of the porcine coronary artery using quin-2. *Pfluegers Arch.* **406**: 173–180, 1986.
- SUNANO, S., AND MIYAZAKI, E.: Effects of caffeine on electrical and mechanical activities of guinea-pig *taenia coli*. *Am. J. Physiol.* **225**: 335–339, 1973.
- SUNANO, S., SHIMADA, T., SHIMAMURA, K., MORIYAMA, K., AND ICHIDA, S.: Extra- and intracellular calcium in vanadate-induced contraction of vascular smooth muscle. *Heart Vessels* **4**: 6–13, 1988.
- SUPATTAPONE, S., DANOFF, S. K., THEIBERT, A., JOSEPH, S. K., STEINER, J., AND SNYDER, S. H.: Cyclic AMP-dependent phosphorylation of a brain inositol trisphosphate receptor decreases its release of calcium. *Proc. Natl. Acad. Sci. USA* **85**: 8747–8750, 1988.
- SUTKO, J. L., AIREY, J. A., WELCH, W., AND RUEST, L.: The pharmacology of ryanodine and related compounds. *Pharmacol. Rev.* **49**: 53–98, 1997.
- SUTKO, J. L., ITO, K., AND KENYON, J. L.: Ryanodine: a modifier of sarcoplasmic reticulum calcium release in striated muscle. *Fed. Proc.* **44**: 2984–2988, 1985.
- SUTKO, J. L., AND WILLERSON, J. T.: Ryanodine alterations of the contractile state of rat ventricular myocardium. *Circ. Res.* **46**: 332–343, 1980.
- SUTKO, J. L., WILLERSON, J. T., TEMPLETON, G. H., JONES, L. R., AND BESCH, H. R.: Ryanodine: its alterations of cat papillary muscle contractile state and representativeness to inotropic interventions and a suggested mechanism of action. *J. Pharmacol. Exp. Ther.* **209**: 37–47, 1979.
- SUTTROP, N., SEEGER, W., DEWEIN, E., BHAKDI, S., AND ROKA, L.: Staphylococcal α -toxin-induced PGI_2 production in endothelial cells: role of calcium. *Am. J. Physiol.* **248**: C127–C134, 1985.
- SUTTROP, N., SEEGER, W., ZINSKY, S., AND BHAKDI, S.: Complement complex C5b-8 induces PGI_2 formation in cultured endothelial cells. *Am. J. Physiol.* **253**: C13–C21, 1987.
- SUZUKI, E., HIRATA, Y., MATSUOKA, H., SUGIMOTO, T., HAYAKAWA, H., SHIN, W. S., TOYOOKA, T., AND SUGIMOTO, T.: Effects of atrial natriuretic peptide on endothelin-induced vasoconstriction and intracellular calcium mobilization. *J. Hypertens.* **9**: 927–934, 1991.
- SUZUKI, A., AND ITOH, T.: Effects of calyculin A on tension and myosin phosphorylation in skinned smooth muscle of the rabbit mesenteric artery. *Br. J. Pharmacol.* **109**: 703–712, 1993.
- SUZUKI, H., OHATA, H., HISAMITSU, T., MIYAHARA, A., AND MOMOSE, K.: All-or-none like responses in increment of cytoplasmic free calcium concentrations to histamine in single smooth muscle cells of guinea pig trachea. *Res. Commun. Mol. Pathol. Pharmacol.* **85**: 291–301, 1994.
- SUZUKI, M., MURAKI, K., IMAIZUMI, Y., AND WATANABE, M.: Cyclopiazonic acid, an inhibitor of the sarcoplasmic reticulum Ca^{2+} -pump, reduces Ca^{2+} -dependent K^+ currents in guinea-pig smooth muscle cells. *Br. J. Pharmacol.* **107**: 134–140, 1992.
- SUZUKI, T., KARAKI, H., AND URAKAWA, N.: Mechanism of inhibition of contraction by high K, Na deficient solution in smooth muscle of guinea pig *taenia coli*. *Arch. Int. Pharmacodyn. Ther.* **248**: 43–49, 1980.
- SUZUKI, T., KARAKI, H., AND URAKAWA, N.: Inhibition of contraction by swelling of vascular smooth muscle in high KCl, low Na solution. *Arch. Int. Pharmacodyn. Ther.* **250**: 195–203, 1981.
- SWARD, K., JOSEFSSON, M., LYDRUP, M. L., AND HELLSTRAND, P.: Effects of metabolic inhibition on cytoplasmic calcium and contraction in smooth muscle of rat portal vein. *Acta Physiol. Scand.* **148**: 265–272, 1993.
- SZAL, S. E., REPKE, J. T., SEELY, E. W., GRAVES, S. W., PARKER, C. A., AND MORGAN, K. G.: $[Ca^{2+}]_i$ signaling in pregnant human myometrium. *Am. J. Physiol.* **267**: E77–E87, 1994.
- TACHIBANA, K., SCHEUNER, P. J., TSUKITANI, Y., KIKUCHI, H., VAM ENGEN, D., CLARIDY, J., GOPICHAND, Y., AND SCHMITZ, F. J.: Okadaic acid, a cytotoxic polyether from two marine sponges of the genus *Halichondria*. *J. Am. Chem. Soc.* **103**: 2469–2471, 1981.
- TAJIMI, M., HORI, M., MITSU, M., OZAKI, H., AND KARAKI, H.: Inhibitory effect of forskolin on myosin phosphorylation-dependent and independent contractions in bovine tracheal smooth muscle. *J. Smooth Muscle Res.* **31**: 129–142, 1995.
- TAJIMI, M., OZAKI, H., SATO, K., AND KARAKI, H.: Effect of a novel inhibitor of cyclic AMP phosphodiesterase, E-1020, on cytosolic Ca^{++} level and contraction in vascular smooth muscle. *Naunyn-Schmiedeberg's Arch. Pharmacol.* **344**: 602–610, 1991.
- TAKAHASHI, K., HIWADA, K., AND KOKUBO, T.: Isolation and characterization of a 34,000 dalton calmodulin- and F-actin-binding protein from chicken gizzard smooth muscle. *Biochem. Biophys. Res. Commun.* **141**: 20–26, 1986.
- TAKAHASHI, K., HIWADA, K., AND KOKUBO, T.: Vascular smooth muscle calponin: A novel calcium- and calmodulin-binding troponin T-like protein. *Hypertension* **11**: 620–626, 1988.
- TAKAHASHI, M., OHIZUMI, Y., AND YASUMOTO, T.: Maitotoxin, a Ca^{2+} channel activator candidate. *J. Biol. Chem.* **257**: 7287–7289, 1982.
- TAKAI, A., BIALOJAN, C., TROSCHEK, M., AND RUEGG, J. C.: Smooth muscle myosin phosphatase inhibition and force enhancement by black sponge toxin. *FEBS Lett.* **217**: 81–84, 1987.
- TAKAYAMA, M., OZAKI, H., AND KARAKI, H.: Effects of a myosin light chain kinase inhibitor, wortmannin, on cytoplasmic Ca^{2+} levels, myosin light chain phosphorylation and force in vascular smooth muscle. *Naunyn-Schmiedeberg's Arch. Pharmacol.* **354**: 120–127, 1996.
- TAKAYANAGI, I., KIUCHI, Y., OHTSUKI, H., AND HARADA, M.: Activation of propylbenzylcholine mustard-sensitive muscarinic cholinergic receptors more effectively utilizes cytosolic Ca^{2+} for contraction in guinea-pig intestinal smooth muscle. *Eur. J. Pharmacol.* **187**: 139–142, 1990.
- TAKAYANAGI, I., KOIKE, K., SATOH, M., AND OKAYASU, A.: Drug receptor mechanisms in smooth muscle: β -chloroethylamine-sensitive and -resistant receptor mechanisms. *Jpn. J. Pharmacol.* **73**: 1–22, 1997.
- TAKAYANAGI, I., AND OHTSUKI, H.: Greater contraction is induced by pilocarpine than by carbachol at the same levels of cytosolic Ca^{2+} concentration in isolated longitudinal muscle of guinea pig ileum. *Jpn. J. Pharmacol.* **53**: 525–528, 1990.
- TAKAYANAGI, I., AND ONOZUKA, S.: Greater tension is developed at the same level of cytosolic Ca^{2+} concentration in the response of clonidine, an adrenergic partial agonist, than in the response of norepinephrine. *J. Pharmacobiodyn.* **12**: 781–786, 1989.
- TAKAYANAGI, I., AND ONOZUKA, S.: α_1 -adrenergic partial agonists utilize cytosolic Ca^{2+} more effectively for contraction in aortic smooth muscle. *Can. J. Physiol. Pharmacol.* **68**: 1329–1333, 1990.
- TAKEDA, K., SCHINI, V., AND STOECKEL, H.: Voltage-activated potassium, but not calcium currents in cultured bovine aortic endothelial cells. *Pfluegers Arch.* **410**: 385–393, 1987.
- TAKEO, S., AND SAKANASHI, M.: Microsomal calcium-accumulating ability of bovine coronary artery and aorta. *Biochem. Pharmacol.* **34**: 2417–2424, 1985.
- TAKEUCHI, K., ABE, K., YASUJIMA, M., SATO, M., KANAZAWA, M., AND YOSHINAGA, K.: The effect of atrial natriuretic peptide on cytosolic free calcium in cultured vascular smooth muscle cells. *Tohoku J. Exp. Med.* **158**: 47–56, 1989a.
- TAKEUCHI, K., ABE, K., YASUJIMA, M., SATO, M., KASAI, Y., TSUNODA, K., HAGINO, T., KANAZAWA, M., AND YOSHINAGA, K.: Difference between the effects of atrial natriuretic peptide and calcium antagonist on cytosolic free

- calcium in cultured vascular smooth muscle cells. *J. Cardiovasc. Pharmacol.* **13**(suppl. 6): 13–16, 1989b.
- TAKIZAWA, S., HORI, M., OZAKI, H., AND KARAKI, H.: Effects of isoquinoline derivatives, HA1077 and H-7, on cytosolic Ca^{2+} level and contraction in vascular smooth muscle. *Eur. J. Pharmacol.* **250**: 431–437, 1993.
- TAKUWA, Y., AND RASMUSSEN, H.: Measurements of cytoplasmic free Ca^{2+} concentration in rabbit aorta using the photoprotein, aequorin: effect of atrial natriuretic peptide on agonist-induced Ca^{2+} signal generation. *J. Clin. Invest.* **80**: 248–250, 1987.
- TAKUWA, Y., TAKUWA, N., AND RASMUSSEN, H.: Measurement of cytoplasmic free Ca^{2+} concentration in bovine tracheal smooth muscle using aequorin. *Am. J. Physiol.* **253**: C817–C827, 1987.
- TAKUWA, Y., TAKUWA, N., AND RASMUSSEN, H.: The effects of isoproterenol on intracellular calcium concentration. *J. Biol. Chem.* **263**: 762–768, 1988.
- TANAKA, Y., NAKAZAWA, T., ISHIRO, H., UNEYAMA, H., IWATA, S., ISHII, K., AND NAKAYAMA, K.: Ca^{2+} handling mechanisms underlying neuropeptide Y-induced contraction in canine basilar artery. *Eur. J. Pharmacol.* **289**: 59–66, 1995.
- TANG, D. -C., STULL, J. T., KUBOTA, Y., AND KAMM, K.: Regulation of the Ca^{2+} dependence of smooth muscle contraction. *J. Biol. Chem.* **267**: 11839–11845, 1992.
- TANSEY, M. G., HORI, M., KARAKI, H., KAMM, K. E., AND STULL, J. T.: Okadaic acid uncouples myosin light chain phosphorylation and tension in smooth muscle. *FEBS Lett.* **270**: 219–221, 1990.
- TANSEY, M. G., LUBY-PHELPS, K., KAMM, K. E., AND STULL, J. T.: Ca^{2+} -dependent phosphorylation of myosin light chain kinase decrease the Ca^{2+} sensitivity of light chain phosphorylation within smooth muscle cells. *J. Biol. Chem.* **269**: 9912–9920, 1994.
- TANSEY, M. G., WORD, R. A., HIDAKA, H., SINGER, H. A., SCHWORER, C. M., KAMM, K. E., AND STULL, J. T.: Phosphorylation of myosin light chain kinase by the multifunctional calmodulin-dependent protein kinase II in smooth muscle cells. *J. Biol. Chem.* **267**: 12511–12516, 1992.
- TAWADA, Y., FURUKAWA, K., AND SHIGEKAWA, M.: ATP-induced calcium transient in cultured rat aortic smooth muscle cells. *J. Biochem.* **102**: 1499–1509, 1987.
- TAYLOR, C. W.: Ca^{2+} sparks a wave of excitement. *Trends Pharmacol. Sci.* **15**: 271–274, 1994.
- TAYLOR, D. A., AND STULL, J. T.: Calcium dependence of myosin light chain phosphorylation in smooth muscle cells. *J. Biol. Chem.* **263**: 14456–14462, 1988.
- THASTRUP, O.: Role of Ca^{2+} -ATPases in regulation of cellular Ca^{2+} signaling, as studied with the selective microsomal Ca^{2+} -ATPase inhibitor, thapsigargin. *Agents Actions* **29**: 8–15, 1990.
- THIBONNIER, M., BAYER, A. L., SIMONSON, M. S., AND KESTER, M.: Multiple signaling pathways of V_1 -vascular vasopressin receptors of A7r5 cells. *Endocrinology* **129**: 2845–2856, 1991.
- THOMAS, A. P., BIRD, G. ST. J., HAJNOCZKY, G., ROBB-GASPEWR, L. D., AND PUTNEY, J. W.: Spatial and temporal aspects of cellular calcium signaling. *FASEB J.* **10**: 1505–1517, 1996.
- THORENS, S., AND HAEUSLER, G.: Effects of some vasodilators on calcium translocation in intact and fractionated vascular smooth muscle. *Eur. J. Pharmacol.* **54**: 79–91, 1979.
- THORIN-TRESCASES, N., OSTER, L., ATKINSON, J., AND CAPDEVILLE, C.: Norepinephrine and serotonin increase the vasoconstrictor response of the perfused rat tail artery to changes in cytosolic Ca^{2+} . *Eur. J. Pharmacol.* **179**: 469–471, 1990.
- THURINGER, D., AND SAUVE, R.: A patch-clamp study of the Ca^{2+} mobilization from internal stores in bovine aortic endothelial cells: II. Effects of thapsigargin on the cellular Ca^{2+} homeostasis. *J. Membr. Biol.* **130**: 139–148, 1992.
- TODA, N., AND OKAMURA, T.: Nitroxidergic nerve: regulation of vascular tone and blood flow in the brain. *J. Hypertens.* **14**: 423–434, 1996.
- TOMASIC, M., BOYLE, J. P., WORLEY, J. F. III, AND KOTLIKOFF, M. I.: Contractile agonists activate voltage-dependent calcium channels in airway smooth muscle cells. *Am. J. Physiol.* **263**: C106–C113, 1992.
- TOUYZ, R. M., AND SCHIFFRIN, E. L.: Tyrosine kinase signaling pathways modulate angiotensin II-induced calcium ($[Ca^{2+}]_i$) transients in vascular smooth muscle cells. *Hypertension* **27**: 1097–1103, 1996.
- TOUYZ, R. M., TOLLOCZKO, B., AND SCHIFFRIN, E. L.: Insulin attenuates agonist-evoked calcium transients in vascular smooth muscle cells. *Hypertension* **23**(suppl. 1): I25–I28, 1994.
- TOUYZ, R. M., TOLLOCZKO, B., AND SCHIFFRIN, E. L.: Blunted attenuation of angiotensin II-mediated Ca^{2+} transients by insulin in cultured unpassaged vascular smooth muscle cells from spontaneously hypertensive rats. *Am. J. Hypertens.* **8**: 104–112, 1995.
- TRIBE, R. M., BORIN, M. L., AND BLAUSTEIN, M. P.: Functionally and spatially distinct Ca^{2+} stores are revealed in cultured vascular smooth muscle cells. *Proc. Natl. Acad. Sci. USA* **91**: 5908–5912, 1994.
- TRINKLE-MULCAHY, L., ICHIKAWA, K., HARTSHORNE, D. J., SIEGMAN, M. J., AND BUTLER, T. M.: Thiophosphorylation of the 130-kDa subunit is associated with a decreased activity of myosin light chain phosphatase in α -toxin-permeabilized smooth muscle. *J. Biol. Chem.* **270**: 18191–18194, 1995.
- TRONGVANICHNAM, K., MITSUI-SAITO, M., OZAKI, H., AND KARAKI, H.: Effects of chronic oral administration of high dose of levromakalim in vitro contractility of arterial smooth muscle. *Eur. J. Pharmacol.* **303**: 39–45, 1996a.
- TRONGVANICHNAM, K., MITSUI-SAITO, M., OZAKI, H., AND KARAKI, H.: Effects of chronic oral administration of high dose of nicorandil on in vitro contractility of rat arterial smooth muscle. *Eur. J. Pharmacol.* **314**: 83–90, 1996b.
- TRONGVANICHNAM, K., MITSUI-SAITO, M., OZAKI, H., AND KARAKI, H.: Effects of chronic oral administration of isosorbide dinitrate on in vitro contractility of rat arterial smooth muscle. *Jpn. J. Pharmacol.* **71**: 167–173, 1996c.
- TSIEN, R. Y.: New calcium indicators and buffers with high selectivity against magnesium and protons: design, synthesis, and properties of prototype structures. *Biochemistry* **19**: 2396–2404, 1980.
- TSUCHIDA, H., NAMBA, H., SEKI, S., FUJITA, S., TANAKA, S., AND NAMIKI, A.: Role of intracellular Ca^{2+} pools in the effects of halothane and isoflurane on vascular smooth muscle contraction. *Anesth. Analg.* **78**: 1067–1076, 1994.
- TSUCHIDA, H., NAMBA, H., YAMAKAGE, M., FUJITA, S., NOTSUKI, E., AND NAMIKI, A.: Effects of halothane and isoflurane on cytosolic calcium ion concentrations and contraction in the vascular smooth muscle of the rat aorta. *Anesthesiology* **78**: 531–540, 1993.
- TSUDA, S., URAKAWA, N., AND FUKAMI, J.: The inhibitory effect of papaverine on respiration-dependent contracture of guinea pig *taenia coli* in high-K medium. II. Inhibition of mitochondrial respiration. *Jpn. J. Pharmacol.* **27**: 845–853, 1977.
- TSUKIOKA, M., IINO, M., AND ENDO, M.: pH dependence of inositol 1,4,5-trisphosphate-induced Ca^{2+} release in permeabilized smooth muscle cells of the guinea-pig. *J. Physiol. (Lond.)* **475**: 369–375, 1994.
- UEDA, F., KARAKI, H., AND URAKAWA, N.: Contractile effects of vanadate on monkey and rabbit tracheal smooth muscle. *Arch. Int. Pharmacodyn. Ther.* **276**: 120–132, 1985.
- UEDA, F., KISHIMOTO, T., OZAKI, H., KARAKI, H., AND URAKAWA, N.: Effects of vanadate on mechanical and electrical activities in guinea-pig *taenia coli*. *Jpn. J. Smooth Muscle Res.* **20**: 85–93, 1984.
- UENO, H.: Calcium mobilization in enzymatically isolated single intact and skinned muscle cells of the porcine coronary artery. *J. Physiol. (Lond.)* **363**: 103–118, 1985.
- ULLMER, C., BODDEKE, H. G. W. M., SCHMUCK, K., AND LUBBERT, H.: 5-HT_{2B} receptor-mediated calcium release from ryanodine-sensitive intracellular stores in human pulmonary artery endothelial cells. *Br. J. Pharmacol.* **117**: 1081–1088, 1996.
- URAKAWA, N., AND HOLLAND, W. C.: Ca^{45} uptake and tissue calcium in K-induced phasic and tonic contraction in *taenia coli*. *Am. J. Physiol.* **207**: 873–876, 1964.
- USHIO-FUKAI, M., HIRANO, K., AND KANAIDE, H.: The effects of a novel vasodilator, LP-805, on cytosolic Ca^{2+} concentrations and on tension in rabbit isolated femoral arteries. *Br. J. Pharmacol.* **113**: 1173–1182, 1994.
- USUKI, T., OBARA, K., SOMEYA, T., OZAKI, H., KARAKI, H., FUSEYANI, N., AND YABU, H.: Calyculin A increases voltage-dependent inward current in smooth muscle cells isolated from guinea pig *taenia coli*. *Experientia* **47**: 939–941, 1991.
- USUKI, T., SOMEYA, T., YOSHINO, M., OBARA, K., OZAKI, H., KARAKI, H., AND YABU, H.: Effect of calyculin A on calcium channel currents of smooth muscle cells isolated from guinea-pig *taenia coli*. *In* *Bioinformatics*, ed. by O. Hatase, and J. H. Wang, pp. 121–124, Elsevier Science Publishers, Amsterdam, 1989.
- UYAMA, Y., IMAIZUMI, Y., AND WATANABE, M.: Effects of cyclopiazonic acid, a novel Ca^{2+} -ATPase inhibitor, on contractile responses in skinned ileal smooth muscle. *Br. J. Pharmacol.* **106**: 208–214, 1992.
- UYAMA, Y., IMAIZUMI, Y., AND WATANABE, M.: Cyclopiazonic acid, an inhibitor of Ca^{2+} -ATPase in sarcoplasmic reticulum, increases excitability in ileal smooth muscle. *Br. J. Pharmacol.* **110**: 565–572, 1993.
- VACA, L., AND KUNZE, D. L.: Depletion of intracellular Ca^{2+} stores activates a Ca^{2+} -selective channel in vascular endothelium. *Am. J. Physiol.* **267**: C920–C925, 1994.
- VACA, L., AND KUNZE, D. L.: IP₃-activated Ca^{2+} channels in the plasma membrane of cultured vascular endothelial cells. *Am. J. Physiol.* **269**: C733–C738, 1995.
- VADULA, M. S., KLEINMAN, J. G., AND MADDEN, J. A.: Effect of hypoxia and norepinephrine on cytoplasmic free Ca^{2+} in pulmonary and cerebral arterial myocytes. *Am. J. Physiol.* **265**: L591–L597, 1993.
- VAN BREEMEN, C., AARONSON, P., AND LOUTZENHISER, R.: Sodium-calcium interactions in mammalian smooth muscle. *Pharmacol. Rev.* **30**: 167–208, 1979.
- VAN BREEMEN, C., CAUVIN, C., HWANG, O., LEYTEN, P., LUKEMAN, S., MEISHERI, K., SAIDA, K., AND YAMAMOTO, H.: Mechanisms of selective Ca antagonist-induced vasodilation. *In* *Calcium Antagonists*, ed. by N. Sperelakis, and J. B. Caulfield, pp. 63–76, Martinus Nijhoff Publishing, Boston, 1984.
- VAN BREEMEN, C., CHEN, Q., AND LAHER, I.: Superficial buffer barrier function of smooth muscle sarcoplasmic reticulum. *Trends Pharmacol. Sci.* **16**: 98–105, 1995.
- VAN BREEMEN, C., FARINAS, B. R., GERBA, P., AND MCNAUGHTON, E. D.: Excitation-contraction coupling in rabbit aorta studied by the lanthanum method for measuring cellular calcium influx. *Circ. Res.* **30**: 44–54, 1972.
- VAN BREEMEN, C., HAWANG, K., LOUTZENHISER, R., LUKEMAN, S., AND YAMAMOTO, H.: Ca entry into vascular smooth muscle. *In* *Proceedings of "Bayer Symposia"*, ed. by A. Fleckenstein, and C. Van Bremen, vol. 9, pp. 58–71, Springer-Verlag, Berlin, 1985.
- VAN BREEMEN, C., HWANG, O., AND MEISHERI, K. D.: The mechanism of inhib-

- itory action of diltiazem on vascular smooth muscle contractility. *J. Pharmacol. Exp. Ther.* **218**: 459–463, 1981.
- VAN BREEMEN, C., AND SAIDA, K.: Cellular mechanisms regulating $[Ca^{2+}]_i$ smooth muscle. *Ann. Rev. Physiol.* **51**: 315–329, 1989.
- VAN DER BENT, V., AND BENY, J. L.: Mechanisms controlling caffeine-induced relaxation of coronary artery of the pig. *Br. J. Pharmacol.* **103**: 1877–1882, 1991.
- VAN RIPER, D. A., CHEN, X. -L., GOULD, E. M., AND REMBOLD, C. M.: Focal increases in $[Ca^{2+}]_i$ may account for apparent low Ca^{2+} sensitivity in swine carotid artery. *Cell Calcium* **19**: 501–508, 1996.
- VAN RIPER, D. A., WEAVER, B. A., STULL, J. T., AND REMBOLD, C. M.: Myosin light chain kinase phosphorylation in swine carotid artery contraction and relaxation. *Am. J. Physiol.* **268**: H2466–H2475, 1995.
- VERBIST, J., WUYTACK, F., RAEYMAEKERS, L., AND CASTEELS, R.: Inhibitory antibodies to plasmalemmal Ca^{2+} -transporting ATPase. *Biochem. J.* **231**: 737–742, 1985.
- VIGNE, P., BREITMAYER, J. P., DUVAL, D., FRELIN, C., AND LAZDUNSKI, M.: The Na^+/Ca^{2+} antiporter in aortic smooth muscle cells: characterization and demonstration of an activation by phorbol esters. *J. Biol. Chem.* **263**: 8078–8083, 1988.
- VOGALIS, F., PUBLICOVER, N. G., HUME, J. R., AND SANDERS, K. M.: Relationship between calcium current and cytosolic calcium in canine gastric smooth muscle cells. *Am. J. Physiol.* **260**: C1012–C1018, 1991.
- VOGALIS, F., PUBLICOVER, N. G., AND SANDERS, K. M.: Regulation of calcium current by voltage and cytoplasmic calcium in canine gastric smooth muscle. *Am. J. Physiol.* **262**: C691–C700, 1992.
- VON DER WEID, P. Y., SEREBRYAKOV, V. N., ORALLO, F., BERGMANN, C., SNETKOV, V. A., AND TAKEDA, K.: Effects of ATP on cultured smooth muscle cells from rat aorta. *Br. J. Pharmacol.* **108**: 638–645, 1993.
- VOYNO-YASENETSKAYA, T. A., TKACHUK, V. A., CHEKNOVA, E. G., PANCHENKO, M. P., GRIGORIAN, G. Y., VAVREK, R. J., STEWART, J. M., AND RYAN, U. S.: Guanine nucleotide-dependent, pertussis toxin-insensitive regulation of phosphoinositide turnover by bradykinin in bovine pulmonary artery endothelial cells. *FASEB J.* **3**: 44–51, 1989.
- WAGNER-MANN, C., AND STUREK, M.: Endothelin mediates Ca influx and release in porcine coronary smooth muscle cells. *Am. J. Physiol.* **260**: C771–C777, 1991.
- WAGNER-MANN, C., HU, Q., AND STUREK, M.: Multiple effects of ryanodine on intracellular free Ca^{2+} in smooth muscle cells from bovine and porcine coronary artery: modulation of sarcoplasmic reticulum function. *Br. J. Pharmacol.* **105**: 903–911, 1992.
- WALDRON, R. T., SHORT, A. D., MEADOWS, J. J., GHOSH, T. K., AND GILL, D. L.: Endoplasmic reticulum calcium pump expression and control of cell growth. *J. Biol. Chem.* **269**: 11927–11933, 1994.
- WALSH, M. P.: Caldesmon, a major actin- and calmodulin-binding protein of smooth muscle. *In Progress in Clinical and Biological Research: Regulation and Contraction of Smooth Muscle*, ed. by M. J. Siegman, A. P. Somlyo and N. L. Stephens, vol. 245, pp. 119–141, Alan R. Liss, New York, 1987.
- WALSH, M. P.: Smooth muscle caldesmon. *In Frontiers in Smooth Muscle Research*, ed. by N. Sperlakis, and J. D. Wood, pp. 127–140, Alan R. Liss, New York, 1990.
- WANG, G. J., SHAN, J., PANG, P. K., YANG, M. C., CHOU, C. J., AND CHEN, C. F.: The vasorelaxing action of rutaecarpine: direct paradoxical effects on intracellular calcium concentration of vascular smooth muscle and endothelial cells. *J. Pharmacol. Exp. Ther.* **276**: 1016–1021, 1996.
- WANG, J. Y. J., AND MCMHIRTER, J. R.: Tyrosine-kinase-dependent signaling pathways. *Trends Cardiovasc. Med.* **4**: 264–270, 1994.
- WANG, X., LAU, F., LI, L., YOSHIKAWA, A., AND VAN BREEMEN, C.: Acetylcholine-sensitive intracellular Ca^{2+} store in fresh endothelial cells and evidence for ryanodine receptors. *Circ. Res.* **77**: 37–42, 1995.
- WANG, X. B., OSUGI, T., AND UCHIDA, S.: Different pathways for Ca^{2+} influx and intracellular release of Ca^{2+} mediated by muscarinic receptors in ileal longitudinal smooth muscle. *Jpn. J. Pharmacol.* **58**: 407–415, 1992.
- WANG, Y., BAIMBRIDGE, K. G., AND MATHERS, D. A.: Effect of serotonin on intracellular free calcium of rat cerebrovascular smooth muscle cells in culture. *Can. J. Physiol. Pharmacol.* **69**: 393–399, 1991.
- WANG, Y., SHIN, W. S., KAWAGUCHI, H., INUKAI, M., KATO, M., SAKAMOTO, A., UEHARA, Y., MIYAMOTO, M., SHIMAMOTO, N., KORENAGA, R., ANDO, J., AND TOYO-OKA, T.: Contribution of sustained Ca^{2+} elevation for nitric oxide production in endothelial cells and subsequent modulation of Ca^{2+} transient in vascular smooth muscle cells in coculture. *J. Biol. Chem.* **271**: 5647–5655, 1996.
- WARD, S. M., VOGALIS, F., BLONDFIELD, D. P., OZAKI, H., FUSEYANI, N., UEMURA, D., PUBLICOVER, N. G., AND SANDERS, K. M.: Inhibition of electrical slow waves and Ca^{2+} currents of gastric and colonic smooth muscle by phosphatase inhibitors. *Am. J. Physiol.* **261**: C64–C70, 1991.
- WATANABE, C., YAMAMOTO, H., HIRANO, K., KOBAYASHI, S., AND KANAIDE, H.: Mechanisms of caffeine-induced contraction and relaxation of rat aortic smooth muscle. *J. Physiol. (Lond.)* **456**: 193–213, 1992.
- WATANABE, H., TAKAHASHI, R., ZHANG, X. X., KAKIZAWA, H., HAYASHI, H., AND OHNO, R.: Inhibition of agonist-induced Ca^{2+} entry in endothelial cells by myosin light-chain kinase inhibitor. *Biochem. Biophys. Res. Commun.* **225**: 777–784, 1996.
- WATANABE, M.: Effect of 2,3-butanedione monoxime on smooth-muscle contraction of guinea-pig portal vein. *Pfluegers Arch.* **425**: 462–468, 1993.
- WATERS, D., AND LESPERANCE, J.: Calcium channel blockers and coronary atherosclerosis: from the rabbit to the real world. *Am. Heart J.* **128**: 1309–1316, 1994.
- WATTS, S. W., YEUM, C. H., CAMPBELL, G., AND WEBB, R. C.: Serotonin stimulates protein tyrosyl phosphorylation and vascular contraction via tyrosine kinase. *J. Vasc. Res.* **33**: 288–298, 1996.
- WEBER, C., KRUSE, H. J., SELLMAYER, A., ERL, W., AND WEBER, P. C.: Platelet activating factor enhances receptor-operated Ca^{++} -influx and subsequent prostacyclin synthesis in human endothelial cells. *Biochem. Biophys. Res. Commun.* **195**: 874–880, 1993.
- WEBER, J. P., CHOW, W. L., MOSHENKO, J., BELSHER, S., AND MACLEOD, K. M.: Pharmacological investigation of signaling mechanisms contributing to phasic and tonic components of the contractile response of rat arteries to noradrenaline. *Can. J. Physiol. Pharmacol.* **73**: 594–601, 1995.
- WEISS, G. B.: Cellular pharmacology of lanthanum. *Ann. Rev. Pharmacol.* **14**: 343–354, 1974.
- WEISS, G. B.: Calcium and contractility in vascular smooth muscle. *In Advances in General and Cellular Pharmacology*, ed. by T. Narahashi, and C. P. Bianchi, vol. 2, pp. 71–154, Plenum Press, 1977.
- WEISS, G. B.: Use of lanthanum as a tool to delineate calcium mobilization patterns in smooth muscle. *In Episodes from the History of the Rare Earth Elements*, ed. by C. H. Evans, pp. 189–203, Kluwer Academic Publishers, Amsterdam, 1996.
- WEISS, G. B., AND GOODMAN, F. R.: Effects of lanthanum on contraction, calcium distribution and Ca^{45} movements in intestinal smooth muscle. *J. Pharmacol. Exp. Ther.* **169**: 46–55, 1969.
- WEISSBERG, P. L., LITTLE, P. J., AND BOBIK, A.: Spontaneous oscillations in cytoplasmic calcium concentration in vascular smooth muscle. *Am. J. Physiol.* **256**: C951–C957, 1989.
- WELLING, A., BOSSE, E., CAVALIE, A., BOTTLENDER, R., LUDWIG, A., NASTAINCZYK, W., FLOCKERZI, V., AND HOFMANN, F.: Stable co-expression of calcium channel $\alpha 1$, β and $\alpha 2/\delta$ subunits in a somatic cell line. *J. Physiol. (Lond.)* **471**: 749–765, 1993.
- WELLING, A., BOSSE, E., RUTH, P., BOTTLENDER, R., FLOCKERZI, V., AND HOFMANN, F.: Expression and regulation of cardiac and smooth muscle calcium channels. *Jpn. J. Pharmacol.* **58**(suppl. 2): 258P–262P, 1992a.
- WELLING, A., BOSSE, W., RUTH, R., FLOCKERZI, V., AND HOFFMAN, F.: Expression and regulation of cardiac and smooth muscle calcium channels. *Jpn. J. Pharmacol.* **58**: 258–262, 1992b.
- WESTON, A. H., AND EDWARDS, G.: Recent progress in potassium channel opener pharmacology. *Biochem. Pharmacol.* **43**: 47–54, 1992.
- WIBO, M., AND GODFRAIND, T.: Comparative localization of inositol 1,4,5-trisphosphate and ryanodine receptors in intestinal smooth muscle: an analytical subfractionation study. *Biochem. J.* **297**: 415–423, 1994.
- WIER, W. G., AND BLATTER, L. A.: Ca^{2+} -oscillations and Ca^{2+} -waves in mammalian cardiac and vascular smooth muscle cells. *Cell Calcium* **12**: 241–254, 1991.
- WIJETUNGE, S., AND HUGHES, A. D.: Effects of platelet-derived growth factor on voltage-operated calcium channels in rabbit isolated ear artery cells. *Br. J. Pharmacol.* **115**: 534–538, 1995.
- WILLIAMS, D. A., AND FAY, F. S.: Calcium transients and resting levels in isolated smooth muscle cells as monitored with quin 2. *Am. J. Physiol.* **250**: C779–C791, 1986.
- WILLIAMS, D. A., BECKER, P. L., AND FAY, F. S.: Regional changes in calcium underlying contraction of single smooth muscle cells. *Science (Wash. DC)* **235**: 1644–1648, 1987.
- WILLIAMS, D. A., FOGARTY, K. E., TSIEN, R. Y., AND FAY, F. S.: Calcium gradients in single smooth muscle cells revealed by the digital imaging microscope using Fura-2. *Nature (Lond.)* **318**: 558–561, 1985.
- WINQUIST, R. J., BUNTING, P. B., AND SCHOFIELD, T. L.: Blockade of endothelium-dependent relaxation by the amiloride analog dichlorobenzamil: possible role of Na^+/Ca^{2+} exchange in the release of endothelium-derived relaxing factor. *J. Pharmacol. Exp. Ther.* **235**: 644–650, 1985.
- WONG, K., LI, X. B., AND HUNCHUK, N.: N-acetylphingosine (C2-caramide) inhibited neutrophil superoxide formation and calcium influx. *J. Biol. Chem.* **270**: 3056–3062, 1995.
- WONG, T. W., AND GOLDBERG, A. R.: In vitro phosphorylation of angiotensin analogs by tyrosyl protein kinases. *J. Biol. Chem.* **258**: 1022–1025, 1983.
- WORLEY, J. F., QUAYLE, J. M., STANDEN, N. B., AND NELSON, M. T.: Regulation of single calcium channels in cerebral arteries by voltage, serotonin, and dihydropyridines. *Am. J. Physiol.* **261**: H1951–H1960, 1991.
- WRAY, S., AUSTIN, C., TAGGART, M. J., AND BURDYGA, T. V.: pH and smooth muscle function. *In Smooth Muscle Excitation*, ed. by T. Bolton and T. Tomita, pp. 304–314, Academic Press, London, 1996.
- WU, D., KATZ, A., LEE, C. H., AND SIMON, M. I.: Activation of phospholipase C by α_1 -adrenergic receptors is mediated by the α subunits of Gq family. *J. Biol. Chem.* **267**: 25798–25802, 1992.
- WU, S. N., YU, H. S., AND SEYAMA, Y.: Induction of Ca^{2+} oscillations by vasopressin in the presence of tetraethylammonium chloride in cultured vascular smooth muscle cells. *J. Biochem. (Tokyo)* **117**: 309–314, 1995.
- WU, X., SOMLYO, A. V., AND SOMLYO, A. P.: Cyclic GMP-dependent stimulation reverses G-protein-coupled inhibition of smooth muscle myosin light chain phosphorylation. *Biochem. Biophys. Res. Commun.* **220**: 658–663, 1996.
- WUYTACK, F., RAEYMAEKERS, L., SHUTTER, G., AND CASTEELS, R.: Demonstration of the phosphorylated intermediates of the Ca^{2+} -transport ATPase in a

- microsomal fraction and in a ($\text{Ca}^{2+} + \text{Mg}^{2+}$)-ATPase purified from smooth muscle by means of calmodulin affinity chromatography. *Biochim. Biophys. Acta* **693**: 45–52, 1982.
- XIONG, Z., SPERELAKIS, N., AND FENOGLIO-PREISER, C.: Isoproterenol modulates the calcium channels through two different mechanisms in smooth-muscle cells from rabbit portal vein. *Pfluegers Arch.* **428**: 105–113, 1994.
- XUAN, Y. -T., WANG, O. L., AND WHORTON, A. R.: Thapsigargin stimulates calcium entry in vascular smooth muscle cells: nicardipine-sensitive and -insensitive pathway. *Am. J. Physiol.* **262**: C1258–C1265, 1992.
- YABU, H., YOSHINO, M., USUKI, T., SOMEYA, T., OBARA, K., OZAKI, H., AND KARAKI, H.: Modification by calyculin A of inward Ca currents in smooth muscle cells isolated from guinea pig *taenia coli*. *Prog. Clin. Biol. Res.* **327**: 623–626, 1990a.
- YABU, H., YOSHINO, M., USUKI, T., SOMEYA, T., OBARA, K., OZAKI, H., AND KARAKI, H.: Modification by calyculin A of inward Ca current in smooth muscle cells isolated from guinea pig *taenia coli*. In *Frontiers in Smooth Muscle Research*, ed. by N. Sperelakis, and J. D. Wood, pp. 623–626, Wiley-Liss, New York, 1990b.
- YAGI, S., BECKER, P. L., AND FAY, F. S.: Relationship between force and Ca^{2+} concentration in smooth muscle as revealed by measurements on single cells. *Proc. Natl. Acad. Sci. USA* **85**: 4109–4113, 1988.
- YAMAGISHI, T., YANAGISAWA, T., SATOH, K., AND TAIRA, N.: Relaxant mechanisms of cyclic AMP-increasing agents in porcine coronary artery. *Br. J. Pharmacol.* **251**: 253–262, 1994.
- YAMAGISHI, T., YANAGISAWA, T., AND TAIRA, N.: Activation of phospholipase C by the agonist U46619 is inhibited by cromakalim-induced hyperpolarization in porcine coronary artery. *Biochem. Biophys. Res. Commun.* **187**: 1517–1522, 1992a.
- YAMAGISHI, T., YANAGISAWA, T., AND TAIRA, N.: K^+ channel openers, cromakalim and Ki 4032, inhibit agonist-induced Ca^{2+} release in canine coronary artery. *Naunyn-Schmiedeberg Arch. Pharmacol.* **346**: 691–700, 1992b.
- YAMAGUCHI, H., KAJITA, J., AND MADISON, J. M.: Isoproterenol increases peripheral $[\text{Ca}^{2+}]_i$ and decreases inner $[\text{Ca}^{2+}]_i$ in single airway smooth muscle cells. *Am. J. Physiol.* **268**: C771–C779, 1995.
- YAMAKAGE, M., KOHRO, S., KAWAMATA, T., AND NAMIKI, A.: Inhibitory effects of four inhaled anesthetics on canine tracheal smooth muscle contraction and intracellular Ca^{2+} concentration. *Anesth. Analg.* **77**: 67–72, 1993.
- YAMAKAGE, M., KOHRO, S., YAMAUCHI, M., AND NAMIKI, A.: The effects of extracellular pH on intracellular pH, Ca^{2+} and tension of canine tracheal smooth muscle strips. *Life Sci.* **56**: PL175–PL180, 1995.
- YAMAMOTO, H., AND VAN BREEMEN, C.: Calcium compartments in saponin-skinned cultured vascular smooth muscle cells. *J. Gen. Physiol.* **87**: 369–390, 1986.
- YAMAMOTO, N., WATANABE, H., KAKIZAWA, H., HIRANO, M., KOBAYASHI, A., AND OHNO, R.: A study on thapsigargin-induced calcium ion and cation influx pathways in vascular endothelial cells. *Biochim. Biophys. Acta.* **1266**: 157–162, 1995.
- YAMASHITA, Y., HASEGAWA-SASALD, H., AND SASAKI, T.: Suppression by staurosporine of Ca^{2+} -mobilization triggered by ligation of antigen-specific receptors on T and B lymphocytes: an essential role of protein tyrosine kinase in the signal transduction. *FEBS Lett.* **288**: 46–50, 1991.
- YAMASHITA, T., MASUDA, Y., AND TANAKA, S.: Inhibitory properties of NIP-121, a potassium channel opener, on high potassium- and norepinephrine-induced contraction and calcium mobilization in rat aorta. *J. Cardiovasc. Pharmacol.* **24**: 890–895, 1994.
- YAMAZAWA, T., IINO, M., AND ENDO, M.: Presence of functionally different compartments of the Ca^{2+} store in single intestinal smooth muscle cells. *FEBS Lett.* **301**: 181–184, 1992.
- YANAGISAWA, T., KAWADA, M., AND TAIRA, N.: Nitroglycerin relaxes canine coronary arterial smooth muscle without reducing intracellular Ca^{2+} concentrations measured with fura-2. *Br. J. Pharmacol.* **98**: 469–482, 1989.
- YANAGISAWA, M., KURIHARA, H., KIMURA, S., TOMOBE, Y., KOBAYASHI, M., MITSUI, Y., YAZAKI, Y., GOTO, K., AND MASAKI, T.: A novel potent vasoconstrictor peptide produced by vascular endothelial cells. *Nature (Lond.)* **332**: 411–415, 1988.
- YANAGISAWA, T., AND OKADA, Y.: KCl depolarization increases Ca^{2+} sensitivity of contractile elements in coronary arterial smooth muscle. *Am. J. Physiol.* **267**: H614–H621, 1994.
- YANAGISAWA, T., TESHIGAWARA, T., AND TAIRA, N.: Cytoplasmic calcium and the relaxation of canine coronary arterial smooth muscle produced by cromakalim, pinacidil and nicorandil. *Br. J. Pharmacol.* **101**: 157–165, 1990.
- YANAGISAWA, T., YAMAGISHI, T., AND OKADA, Y.: Hyperpolarization induced by K^+ channel openers inhibits Ca^{2+} influx and Ca^{2+} release in coronary artery. *Cardiovasc. Drugs Ther.* **7**(suppl. 3): 565–574, 1993.
- YANG, C. M., HSIA, H. C., HSIEH, J. T., ONG, R., AND LUO, S. F.: Bradykinin-stimulated calcium mobilization in cultured canine tracheal smooth muscle cells. *Cell Calcium* **16**: 59–70, 1994a.
- YANG, C. M., HSIEH, J. T., YO, Y. L., ONG, R., TSAO, H. L.: 5-Hydroxytryptamine-stimulated calcium mobilization in cultured canine tracheal smooth muscle cells. *Cell Calcium* **16**: 194–204, 1994b.
- YANG, C. M., ONG, R., HSIEH, J. T., AND YO, Y. L.: Sarafotoxin-induced calcium mobilization in cultured dog tracheal smooth muscle cells. *J. Receptor Res.* **14**: 423–445, 1994c.
- YANG, C. M., SUNG, T. C., ONG, R., HSIEH, J. T., AND LUO, S. F.: Effect of phorbol ester on phosphoinositide hydrolysis and calcium mobilization in cultured canine tracheal smooth muscle cells. *Naunyn-Schmiedeberg Arch. Pharmacol.* **350**: 77–83, 1994d.
- YANG, C. M., YO, Y. L., ONG, R., AND HSIEH, J. T.: Endothelin- and sarafotoxin-induced phosphoinositide hydrolysis in cultured canine tracheal smooth muscle cells. *J. Neurochem.* **62**: 1440–1448, 1994e.
- YANG, C. M., YO, Y. L., ONG, R., HSIEH, J. T., AND TSAO, H. L.: Calcium mobilization induced by endothelins and sarafotoxin in cultured canine tracheal smooth muscle cells. *Naunyn-Schmiedeberg Arch. Pharmacol.* **350**: 68–76, 1994f.
- YANG, S. G., SAIFEDDINE, M., AND HOLLENBERG, M. D.: Tyrosine kinase inhibitors and the contractile action of epidermal growth factor-urogastrone and other agonists in gastric smooth muscle. *Can. J. Physiol. Pharmacol.* **70**: 85–93, 1992.
- YANG, S. G., SAIFEDDINE, M., LANYONU, A., AND HOLLENBERG, M. D.: Distinct signal transduction pathways for angiotensin-II in guinea pig gastric smooth muscle: differential blockade by indomethacin and tyrosine kinase inhibitors. *J. Pharmacol. Exp. Ther.* **264**: 958–966, 1993.
- YOKOKAWA, K., KOHNO, M., MURAKAWA, K., YASUNARI, K., AND TAKADA, T.: Effect of endothelin-1 on cytosolic calcium ions in cultured human endothelial cells. *J. Hypertens.* **8**: 843–849, 1990.
- YOKOYAMA, T., KASAI, H., OKADA, Y., IZUMI, H., IZAWA, T., AND OGAWA, N.: Effect of Ki 1769, a novel K^+ -channel opener, on sensitivity to Ca^{2+} of contractile elements and inositol phosphate formation in porcine coronary artery. *J. Pharm. Pharmacol.* **47**: 148–151, 1995.
- YOSHIDA, K., AND OKABE, E.: Selective impairment of endothelium-dependent relaxation by sevoflurane: oxygen free radicals participation. *Anesthesiology* **76**: 440–447, 1992.
- YOSHIDA, M., SUZUKI, A., AND ITOH, T.: Mechanisms of vasoconstriction induced by endothelin-1 in smooth muscle of rabbit mesenteric artery. *J. Physiol. (Lond.)* **477**: 253–265, 1994.
- YOSHIDA, Y., SUN, H. T., CAI, J. Q., AND IMAI, S.: Cyclic GMP-dependent protein kinase stimulates the plasma membrane Ca^{2+} pump ATPase of vascular smooth muscle via phosphorylation of a 240-kDa protein. *J. Biol. Chem.* **266**: 19819–19825, 1991.
- YOSHIMURA, H., KAI, T., NISHIMURA, J., KOBAYASHI, S., TAKAHASHI, S., AND KANAIDE, H.: Effects of midazolam on intracellular Ca^{2+} and tension in airway smooth muscles. *Anesthesiology* **83**: 1009–1020, 1995.
- YOUNG, S. H., ENNERS, H. S., AND MAYER, E. A.: Propagation of calcium waves between colonic smooth muscle cells in culture. *Cell Calcium* **20**: 257–271, 1996.
- YU, H. J., HYPOLITE, J. A., WEIN, A. J., AND LEVIN, R. M.: Effect of magnesium ions on rabbit detrusor contractility and intracellular free calcium. *Pharmacology* **51**: 186–194, 1995.
- YUMOTO, K., YAMAGUCHI, H., AND OCHI, R.: Depression of ATP-induced Ca^{2+} signaling by high K^+ and low Cl^- media in human aortic endothelial cells. *Jpn. J. Physiol.* **45**: 111–122, 1995.
- ZERNIG, G.: Widening potential for Ca^{2+} antagonists: non-L-type Ca^{2+} channel interaction. *Trends Pharmacol. Sci.* **11**: 38–44, 1990.
- ZHANG, A., CHENG, T. P., AND ALTURA, B. M.: Magnesium regulates intracellular free ionized calcium concentration and cell geometry in vascular smooth muscle cells. *Biochim. Biophys. Acta.* **1134**: 25–29, 1992.
- ZHANG, H., WEIR, B., MARTON, L. S., MACDONALD, R. L., BINDOKAS, V., MILLER, R. J., AND BRORSON, J. R.: Mechanisms of hemolysate-induced $[\text{Ca}^{2+}]_i$ elevation in cerebral smooth muscle cells. *Am. J. Physiol.* **269**: H1874–H1890, 1995.
- ZHANG, Z. D., KWAN, C. Y., AND DANIEL, E. E.: Subcellular-membrane characterization of tritiated ryanodine-binding sites in smooth muscle. *Biochem. J.* **290**: 259–266, 1993.
- ZHENG, X. F., KWAN, C. Y., AND DANIEL, E. E.: Role of intracellular Ca^{2+} in EDRF release in rat aorta. *J. Vasc. Res.* **31**: 18–24, 1994.
- ZHOLOS, A. V., KOMORI, S., OHASHI, H., AND BOLTON, T. B.: Ca^{2+} inhibition of inositol trisphosphate-induced Ca^{2+} release in single smooth muscle cells of guinea-pig small intestine. *J. Physiol. (Lond.)* **481**: 97–109, 1994.
- ZHU, Z., TEPEL, M., NEUSSER, M., MEHRING, N., AND ZIDEK, W.: Concentration-dependent effects of insulin on Ca^{2+} influx in vascular smooth muscle cells of normotensive and spontaneously hypertensive rats. *Clin. Sci. (Lond.)* **85**: 425–429, 1993a.
- ZHU, Z., TEPEL, M., NEUSSER, M., MEHRING, N., AND ZIDEK, W.: Effect of captopril on vasoconstriction and Ca^{2+} fluxes in aortic smooth muscle. *Hypertension* **22**: 806–811, 1993b.
- ZHU, Z., TEPEL, M., NEUSSER, M., AND ZIDEK, W.: Mechanism of the action of angiotensin-converting enzyme inhibitors on agonist-induced Ca^{2+} influx. *J. Vasc. Res.* **31**: 265–270, 1994.
- ZIMMERMANN, B., SOMLYO, A. V., ELLIS-DAVIES, G. C. R., KAPLAN, J. H., AND SOMLYO, A. P.: Kinetics of phosphorylation reactions and myosin light chain phosphorylation in smooth muscle. *J. Biol. Chem.* **270**: 23966–23974, 1995.
- ZUCCHI, R., AND RONCA-TESTONI, S.: The sarcoplasmic reticulum Ca^{2+} channel/ryanodine receptor: modulation by endogenous effectors, drugs and disease states. *Pharmacol. Rev.* **49**: 1–41, 1997.